









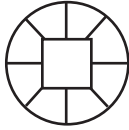

Panel Riser Pack

Installation Instructions

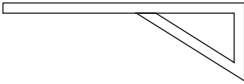
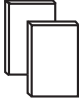
Parts Supplied

Ref	Description	Illustration	Qty
A	1225mm Universal Straight Panels		2
A1	Universal Curved Quad Panel*	 *If your tray is a Quadrant you will receive one panel B2.	1
B	Feet Mounting Brackets		8
C	Threaded Leg Tubes		8
D	Circular Base Plates		8
E	Screws for leg mounting and panel upright brackets		44
F	Panel Upright Brackets		6
G	Magnetic Strip Sets		6
H	Corner / End Brackets		3
I	Joining Brackets		2

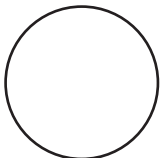
J	Pentangle Joining Brackets		2
K	Circular Adhesive Pads		8

Before You Start

- Please note that although these instructions are comprehensive we always recommend that a technically competent installer undertakes the installation.
- These installation instructions **MUST** be read in conjunction with all instructions supplied with your chosen shower tray.
- For shower trays with one or more dimensions longer than 1200mm and up to 1700mm in length an extension panel kit is required.
- Check the pack and ensure you have all of the parts listed and that this kit is compatible with your chosen shower tray.
- **Note: If in doubt contact your supplier who will be able to help you.**
- When you are ready to start, make sure that you have the right tools and materials to hand with plenty of space and a clean dry area for assembly.

Tools and Materials Required (not supplied)

- Cross-Head Screw Driver
- Sharp Knife and or Mitre Saw
- Spirit Level
- Pipework and fittings as required
- Silicone Sealant and Silicone Cleaning Solvent
- Tape measure
- Marker Pen

N.B. The company reserve the right to change specification or withdraw products from this instruction without prior notice being given.

Foot Assembly

- 1 Screw all the feet mounting brackets (B) to the upper face of the circular base plates (D) using screws (E) (See Fig 1).
- 2 Attach the circular adhesive pads (K) to the under side of all the circular base plates (D) by removing the self adhesive backing paper from one side **ONLY** of the adhesive pads (K), centralise and push firmly into position (See Fig 2).

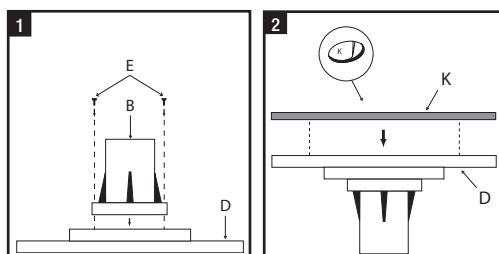

Foot positioning

- 1 With your chosen shower tray upside down, position all (DO NOT PERMANENTLY FIX) the foot assemblies to form an evenly supported structure. Wherever possible use the full number of foot assemblies available for maximum support. For guidance (See Fig 3).

N.B. Some types of Shower trays having pre-designated foot positions may not require the full number of feet available with this kit.

- 2 On panel/open sides of the tray's installation only, screw one (sides only) or two (corners only) of the panel upright brackets (F) as required to the circular base plates (D) using two screws (E) per bracket, ensuring the base plates (D) with (F) attached are inline with the panel sides and NO greater than 80mm from the edge (See Fig 4). On some types of shower trays with a periphery cavity, the 80mm dimension may result in a small amount of the assembly overhanging the standing area, this is normal for this type of tray.
- 3 Once an evenly supported layout plan has been achieved, ensure the base of the tray is clean and free from dust and other contaminants, then remove the remaining self adhesive backing paper from the assembled pads (K) and attach all the assemblies permanently into position.
- 4 Adjust the panel upright brackets (F) to achieve a nominal 6mm gap between the bracket and the tray edge (See Fig 5).

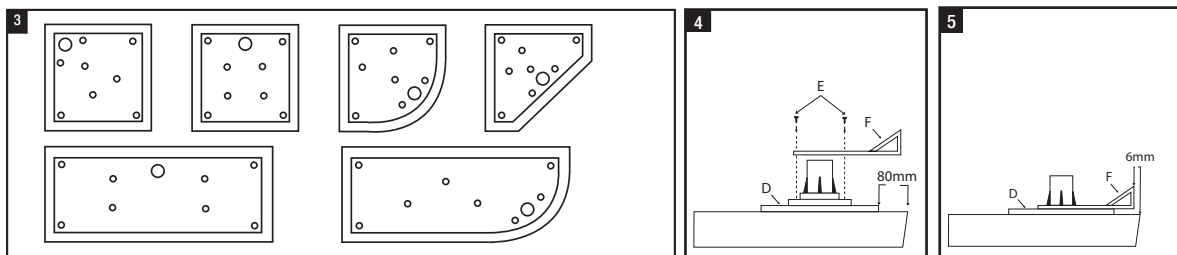

Note! Some types of Gel coated stone resin shower trays and larger trays may require a close fitting plywood base as additional support (NOT supplied). If in doubt consult your supplier.

Note! The panel upright brackets (F) located on the corners can be overlapped at the rear on some types of shower tray if a closer fit to the edge of the shower tray (minimum 15mm) is required (See Fig 6).

N.B. Ensure the circular base plates (K) are securely fitted, if not change position.

- 5 Screw all the threaded leg tubes (C) into the feet mounting brackets (B) to achieve a nominal 95mm from the base of the tray to base of the leg (See Fig 7).

Tray Installation

- 1 Attach a suitable waste outlet to the shower tray and install the plumbing (not supplied) into the chosen area in accordance with the building regulations).

N.B. Wherever possible the installation area should be as level as possible to avoid excessive gaps between the panels and the tray/floor.

- 2 Place the shower tray upright and level into position, adjusting the threaded leg tubes (C) as required maintaining a nominal 95mm gap between the edge of the tray and the floor (See Fig 8).

Note! With the shower tray in the installed position, ensure that your chosen enclosure is compatible with the dimensions of the tray after tiling. This is especially important if a shower tray incorporating a built in tiling upstand is being used or if electing to recess the edge of the tray into adjacent walls.

- 3 Connect the plumbing to the waste outlet on the shower tray and test all connections. The tray **MUST** now be checked for water flow, tightness and drainage over the entire area before proceeding and adjusted or rejected if required.

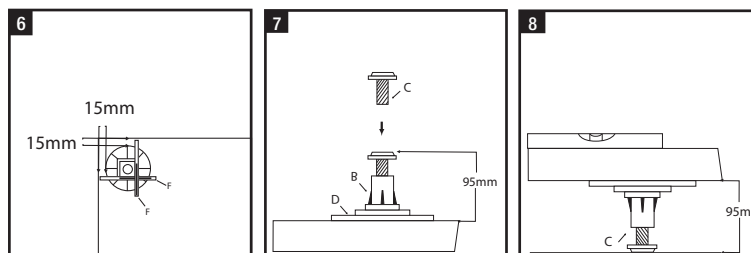

Panel Installation

- Using panels (A or A1) as supplied or required measured and cut using a sharp knife or mitre saw **(taking great care to avoid injury)**, for the size and shape of shower tray being installed up to 1200mm i.e. cut line (X) as applicable (See Fig 9, 10 and 11).

Note! Some panels have a protective film (indicated by a label on the surface) which must be removed now.

- For shower trays greater than 1200mm up to 1700mm, use optional extension kit.

Note! Check the cut panel dimensions against the tray with brackets (H, I and or J) and adjust if required before further assembly.

- Clean all surfaces using a Silicone cleaning solvent (Not supplied) and assemble the panel shape by removing the coloured adhesive backing paper from the brackets being used either (H, I and or J) as required and firmly attach to the panels as shown (See Fig 9, 10 and 11)

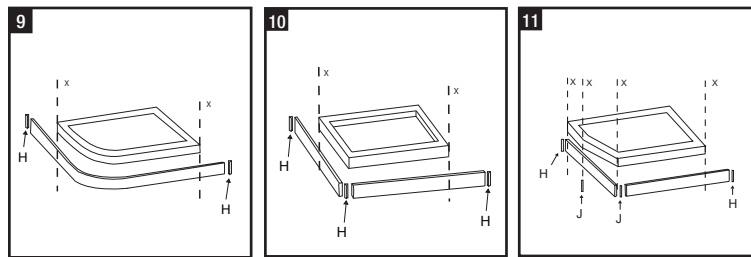

- Using the magnetic strips sets (G) remove the self adhesive backing paper from one side **ONLY** and attach to the ends of the panel upright brackets (F) (See Fig 12).

- Test fit all panels before final assembly, and ensure correct orientation to fit as required).

- After satisfactory test fitting of the panel assembly, remove the remaining self adhesive backing papers from the attached magnetic strip sets (G) and push the panel assembly firmly in to position).

Note! Once the panel assembly is satisfactory in place, these can be sealed if required along the contact points with a suitable silicone sealant (See Fig 13).

- After all checks and adjustments, seal along the tiling line with a suitable sealant (See Fig 14).

Note! After tiling and before fitting of the enclosure, clean the upper surfaces of the shower tray using a Silicone cleaning solvent (Not supplied).

