

<p>*46 238</p>	<p>+30</p>	<p>*19 377</p>	<p>30mm</p>	<p>*19 332</p>	<p>32mm</p>
----------------	------------	----------------	-------------	----------------	-------------



DIN EN
806

DIN EN
1717

DIN
1988



bar

max. 10
5
1

°C

max. 70°
60°

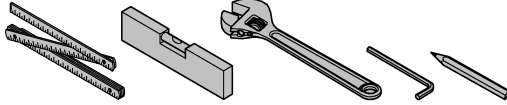
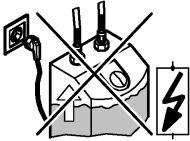

*19 332



*19 377



1

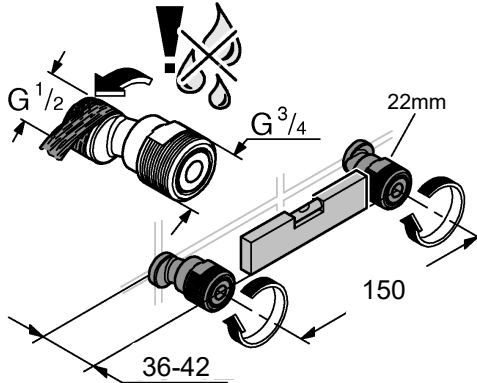
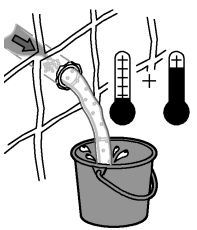

2

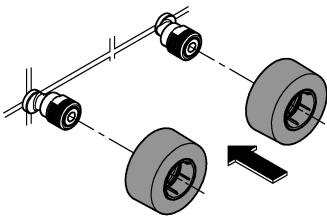

3

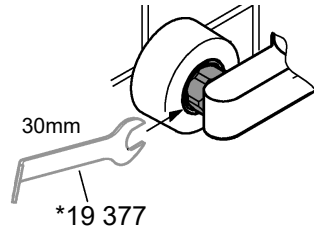

4

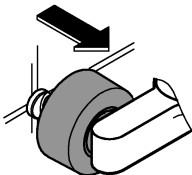

5

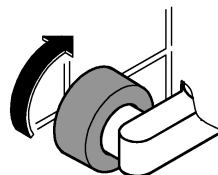



6

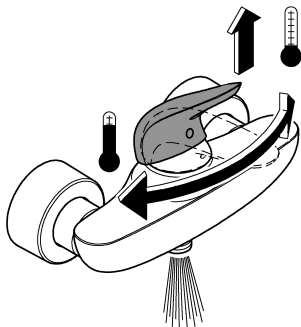
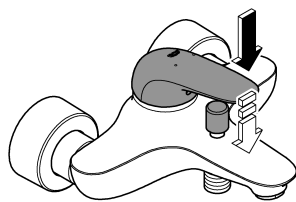
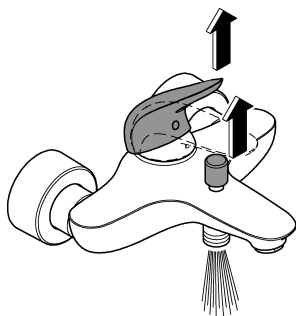
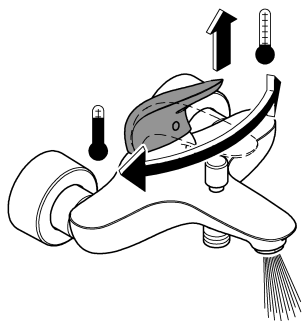
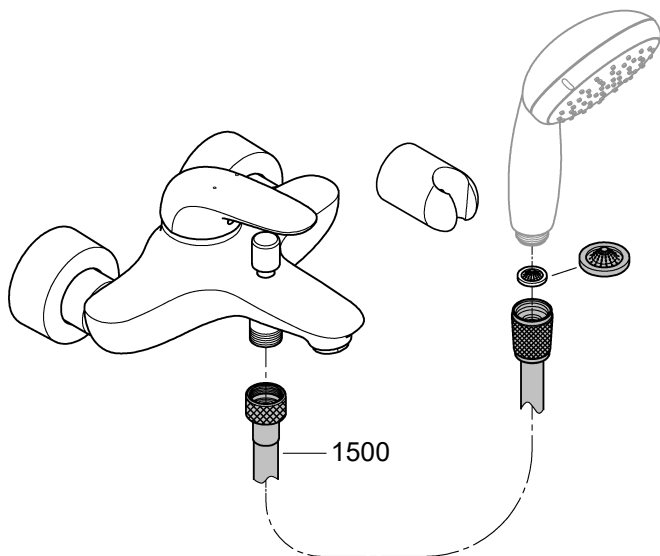

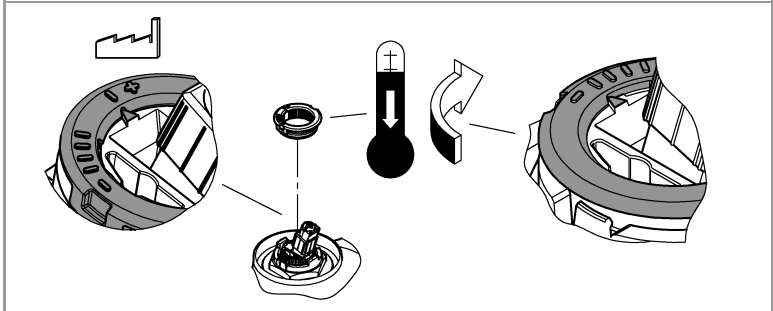
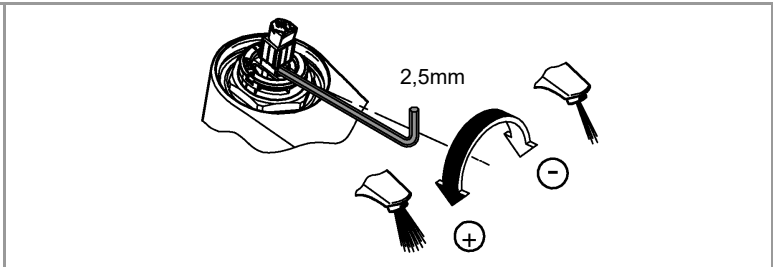
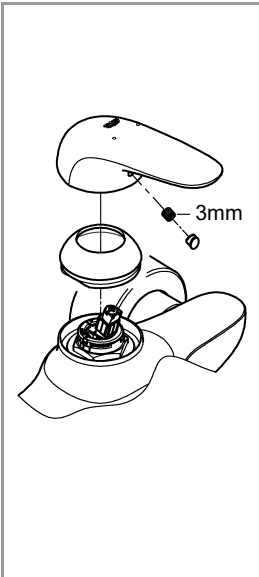

SERVICE

