

Code No.: 33.0021

Dimensions: 1560 x 720(645) x 760(575) mm

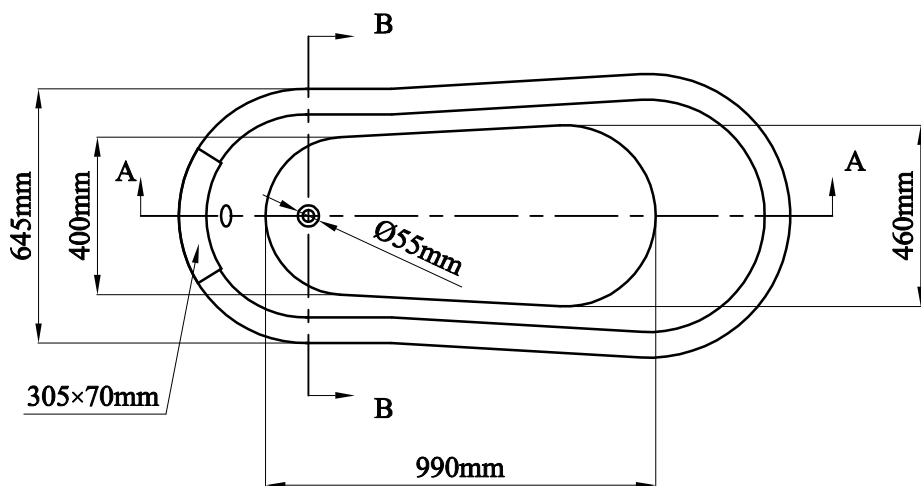
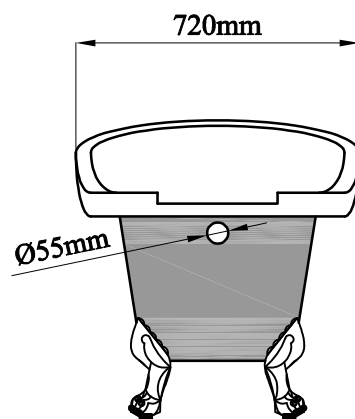
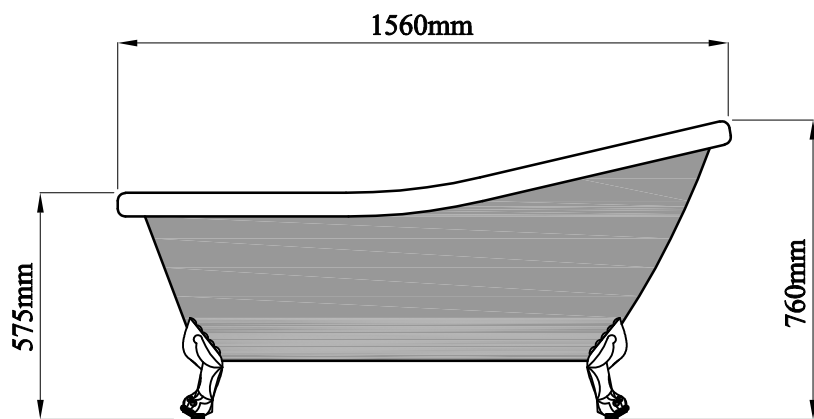

SECTION A-A

SECTION B-B

