

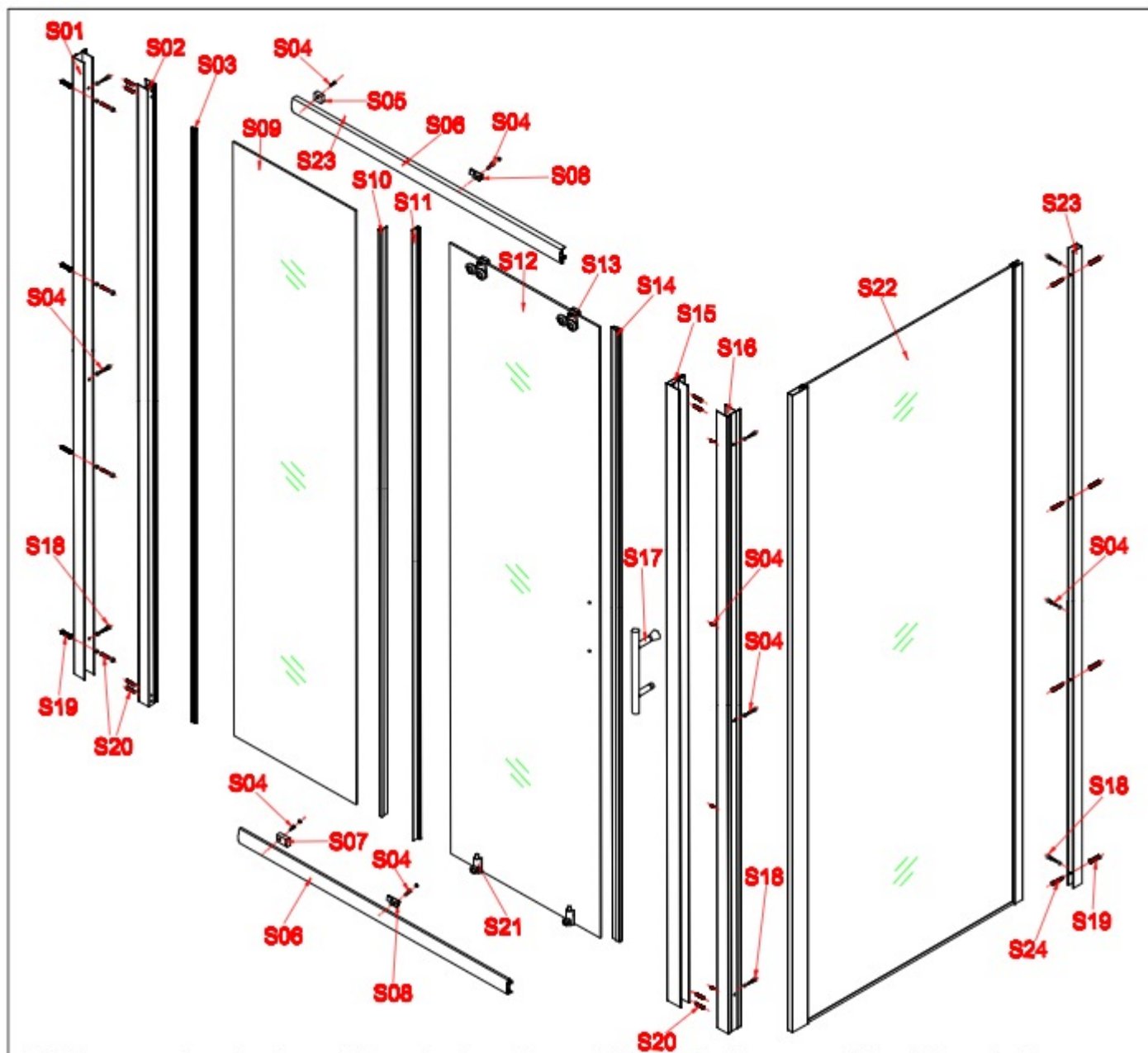













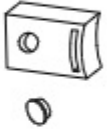
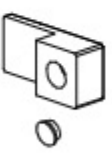

INSTALLATION MANUAL

Eastbrook Code	Adjustment	Eastbrook Code	Adjustment
69.0034	1670-1690	69.0035	1770-1790
69.0036	670-690	69.0037	720-740
69.0038	770-790		

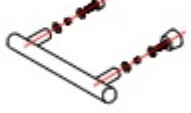

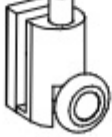

This product should only be fixed by a fully qualified installer

S01 S18  x2	S02  x1	S03  x1	S04  x17	S05  x1	S06  x2	S07  x1
S08  x2	S10 S11  x2	S13  x2	S14  x1	S15  x1	S17  x1	S18  x13
S19  x8	S20  x12	S21  x2	S23  x1	S24  x4		

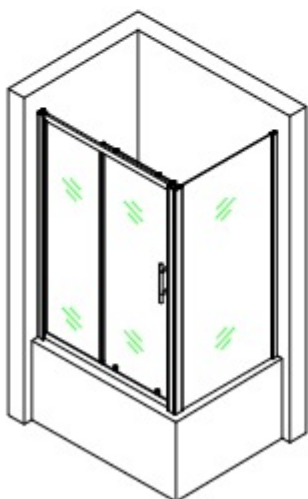
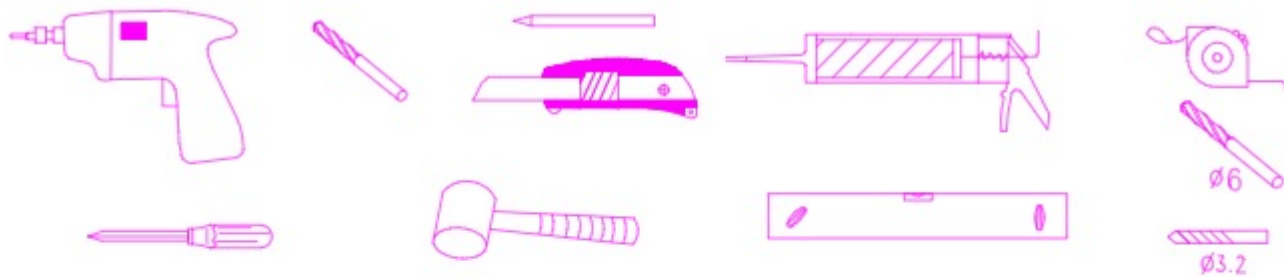

L



R

L-1

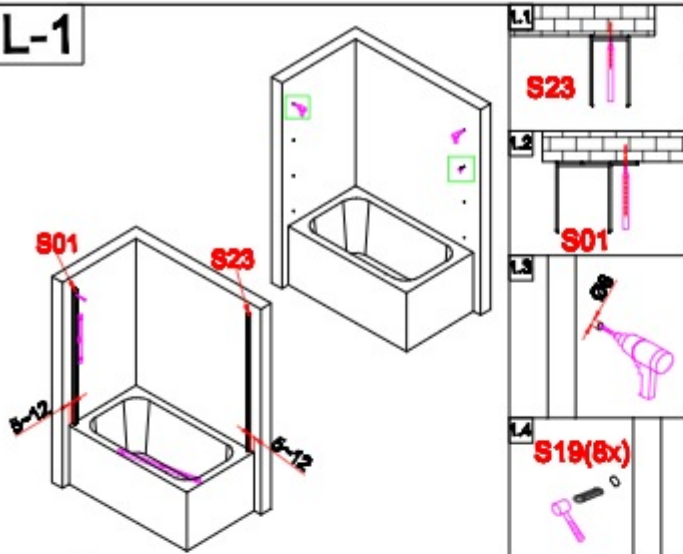

R-1

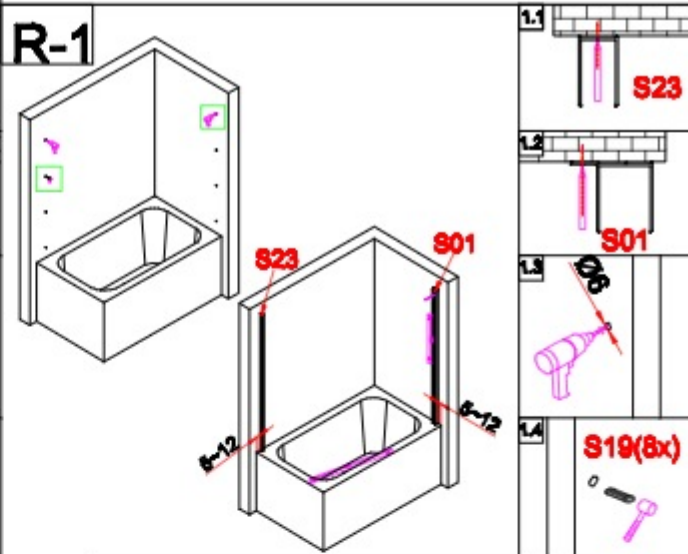

L-2

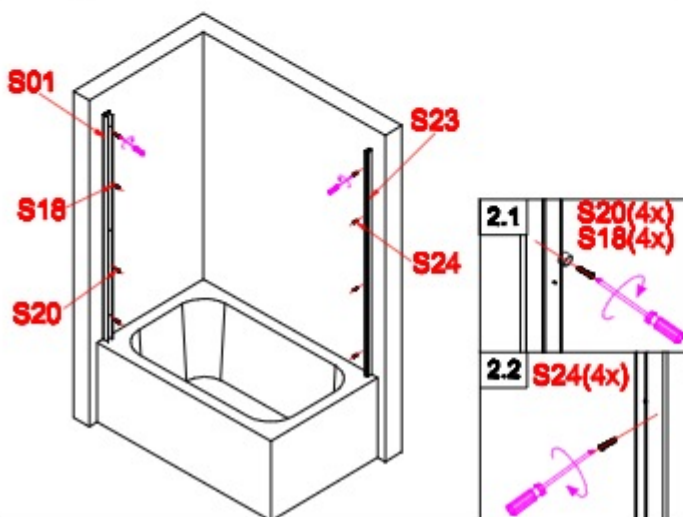

R-2

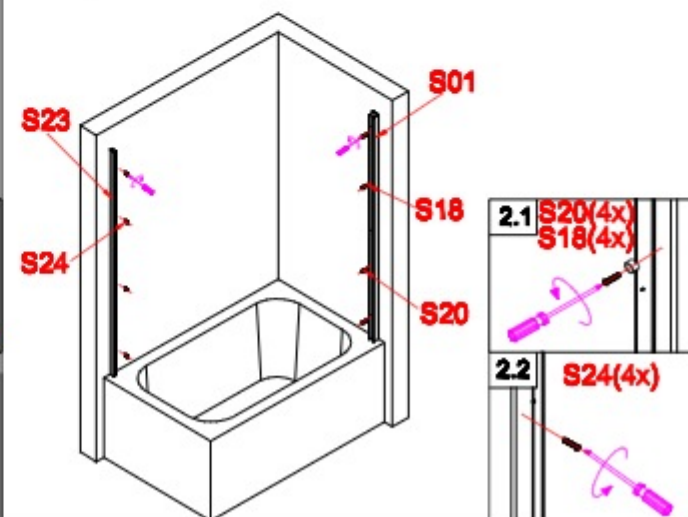

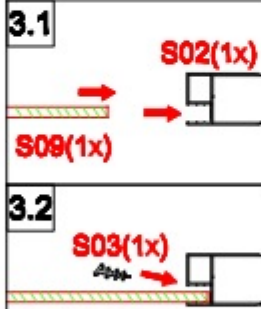
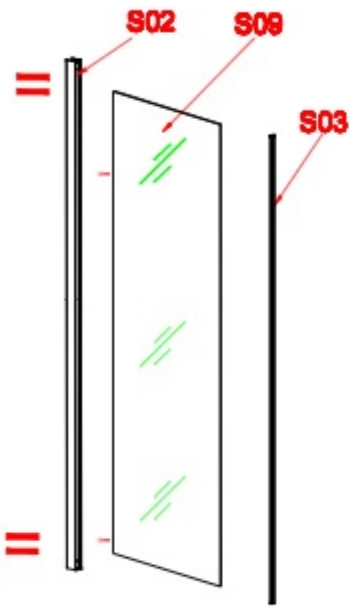
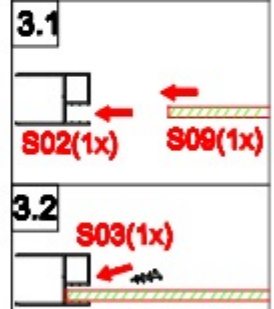
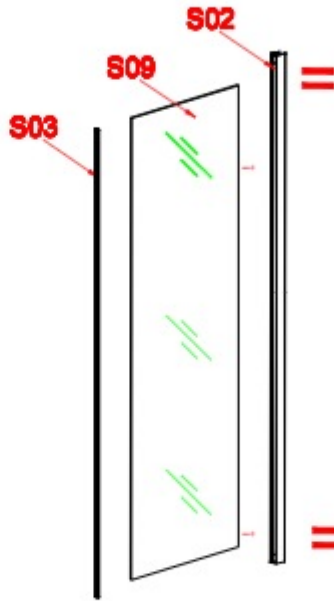
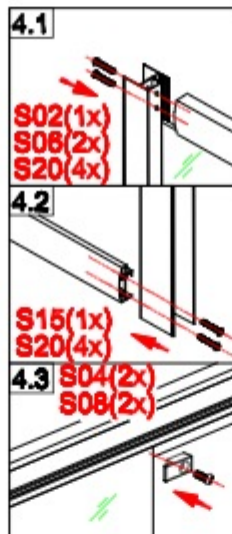
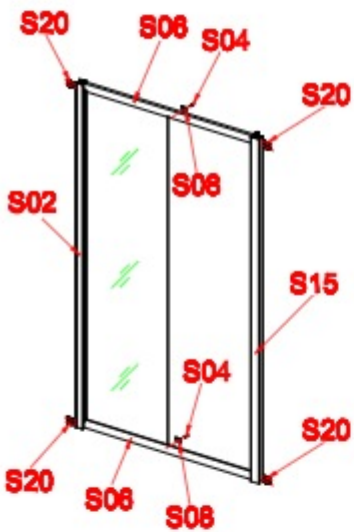
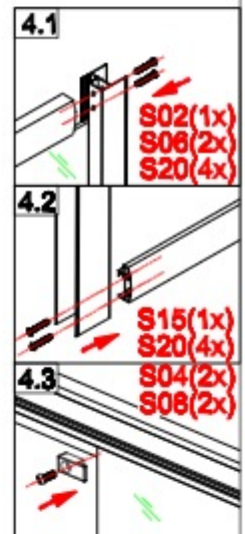
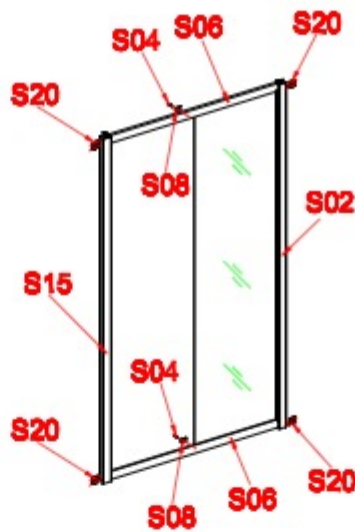
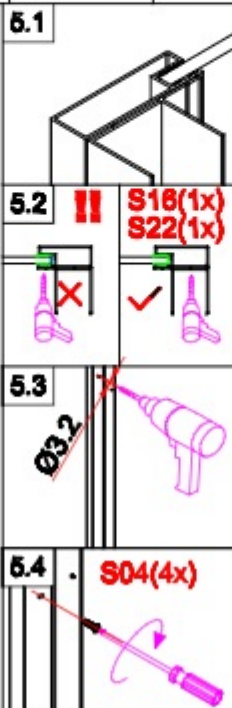
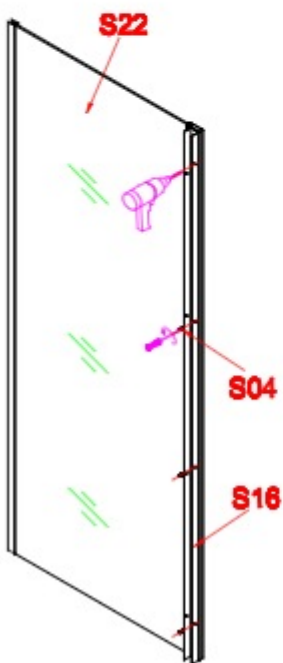
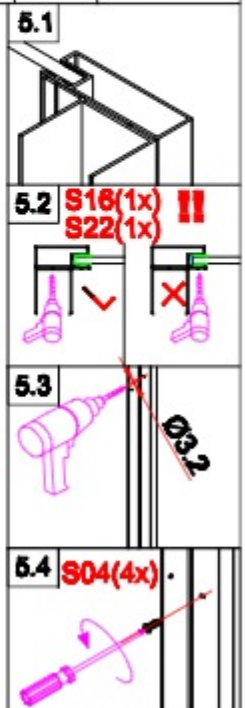
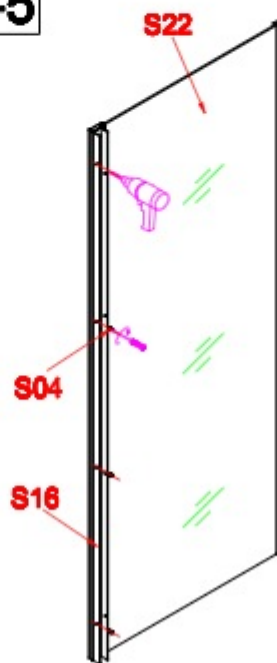
L-3**R-3****L-4****R-4****L-5****R-5**

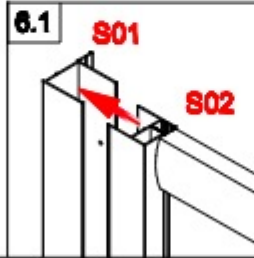
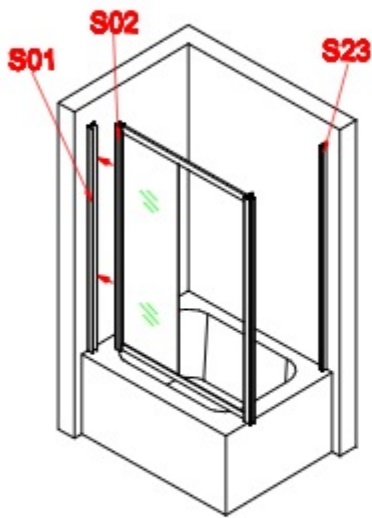
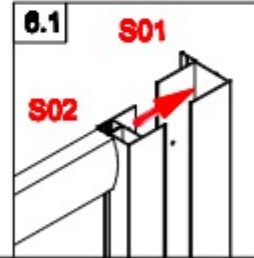
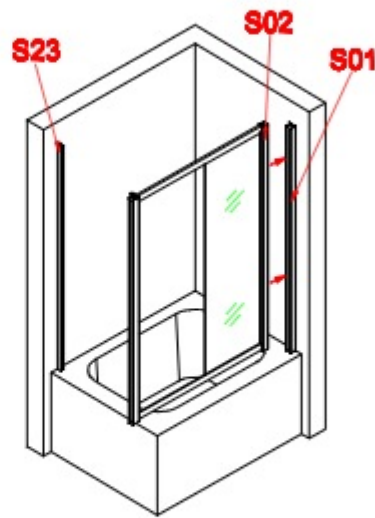
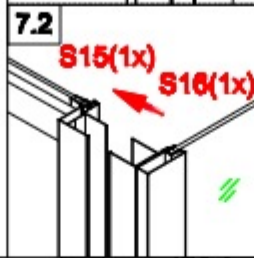
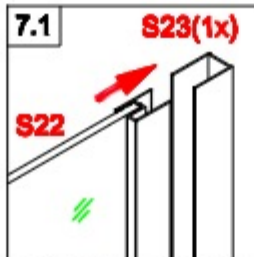
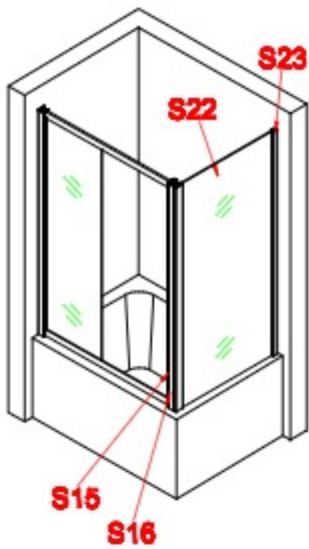
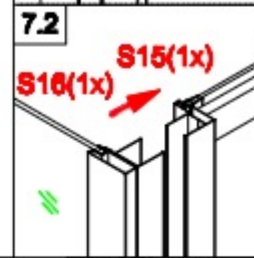
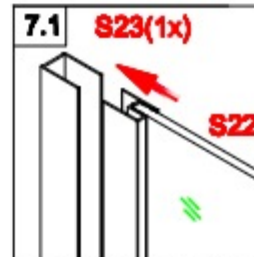
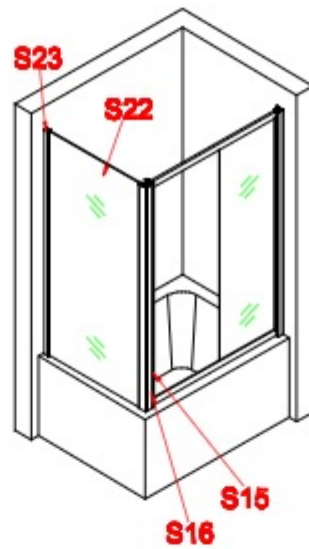
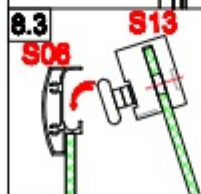
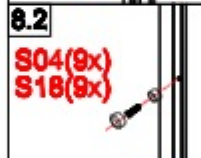
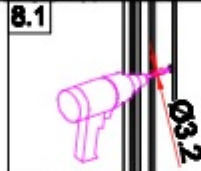
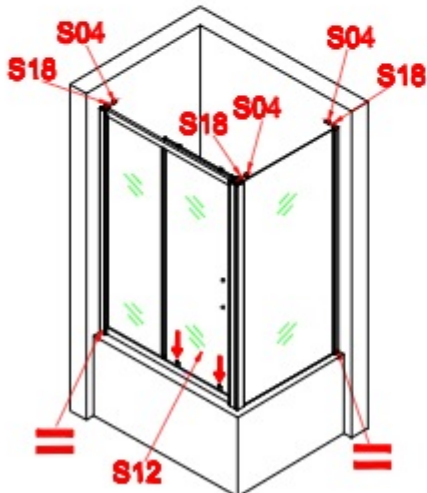
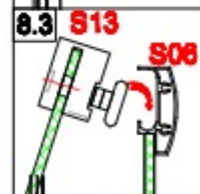
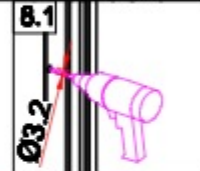
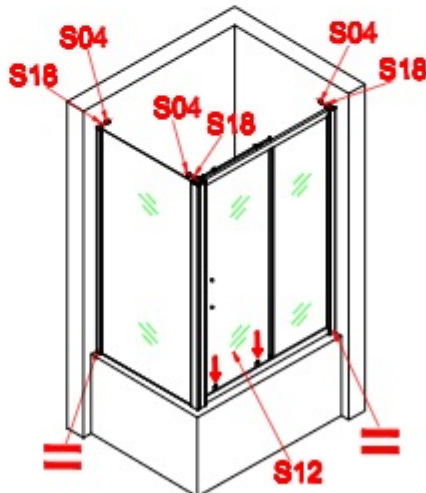
L-6**R-6****L-7****R-7****L-8****R-8**

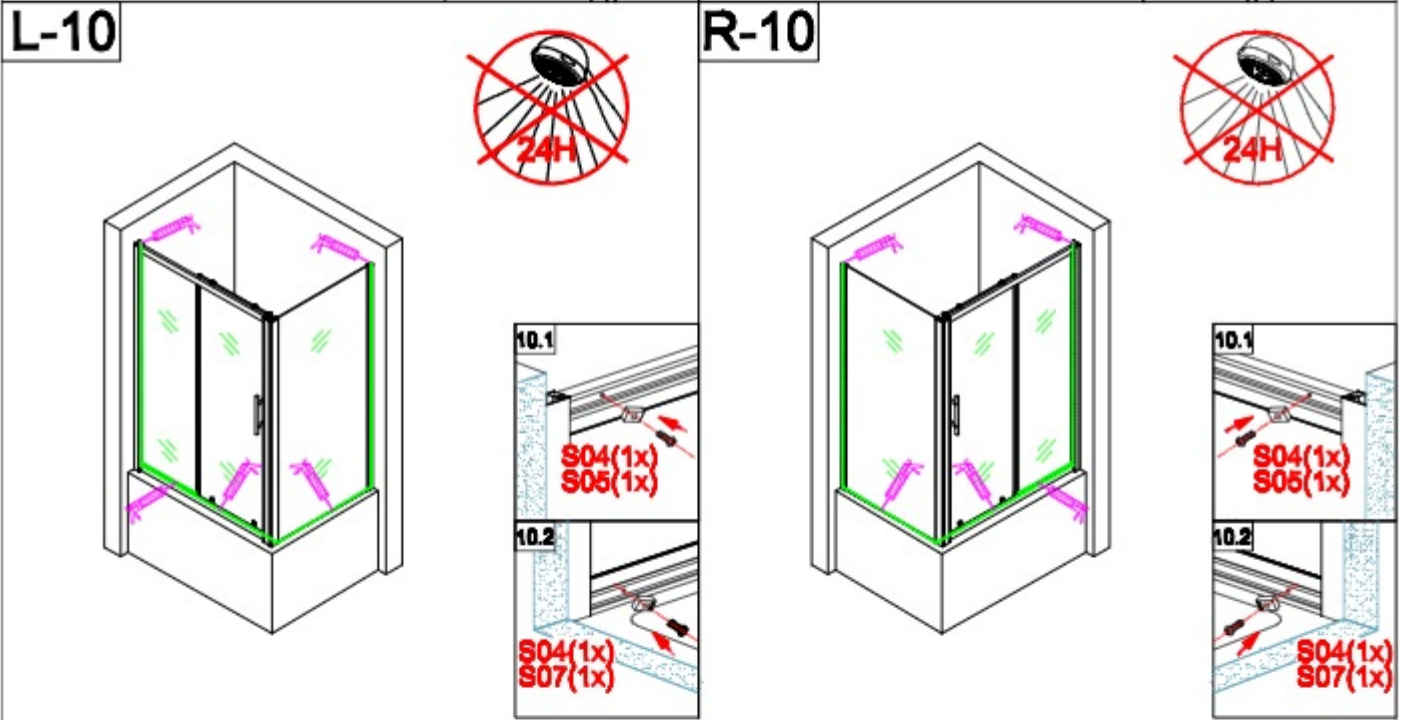
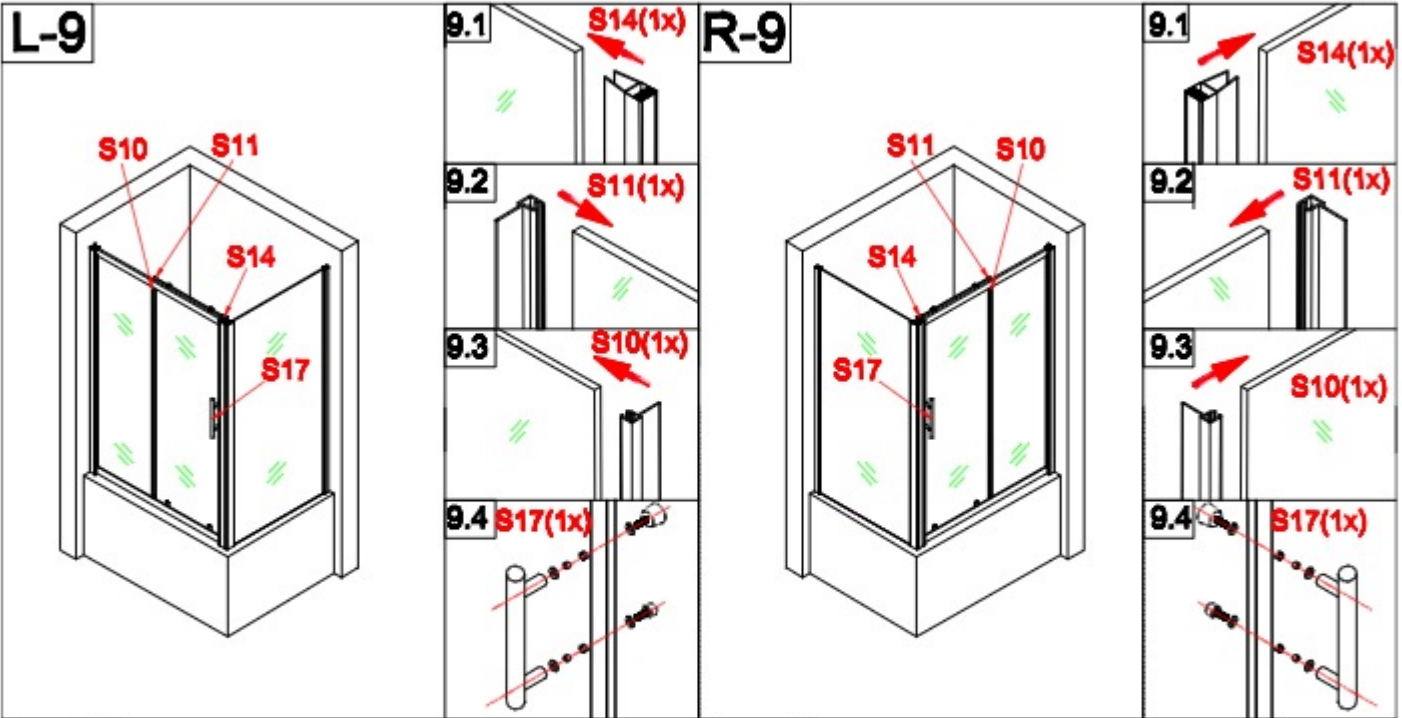

Silicone on the outside of the screen only

Cleaning & Maintenance

Don't clean the shower enclosure with irritant detergent such as alcohol,bleach or other chemical cleaners.

Only clean with warm soapy water.

After the installation is completed,should you find that there is notable noise when the glass door moves,you may add a small quantity of lubricant onto the roller wheel,slipping hook and the track.

Helpline: 01452 317890