

# OFFSET QUADRANT SHOWER TRAY

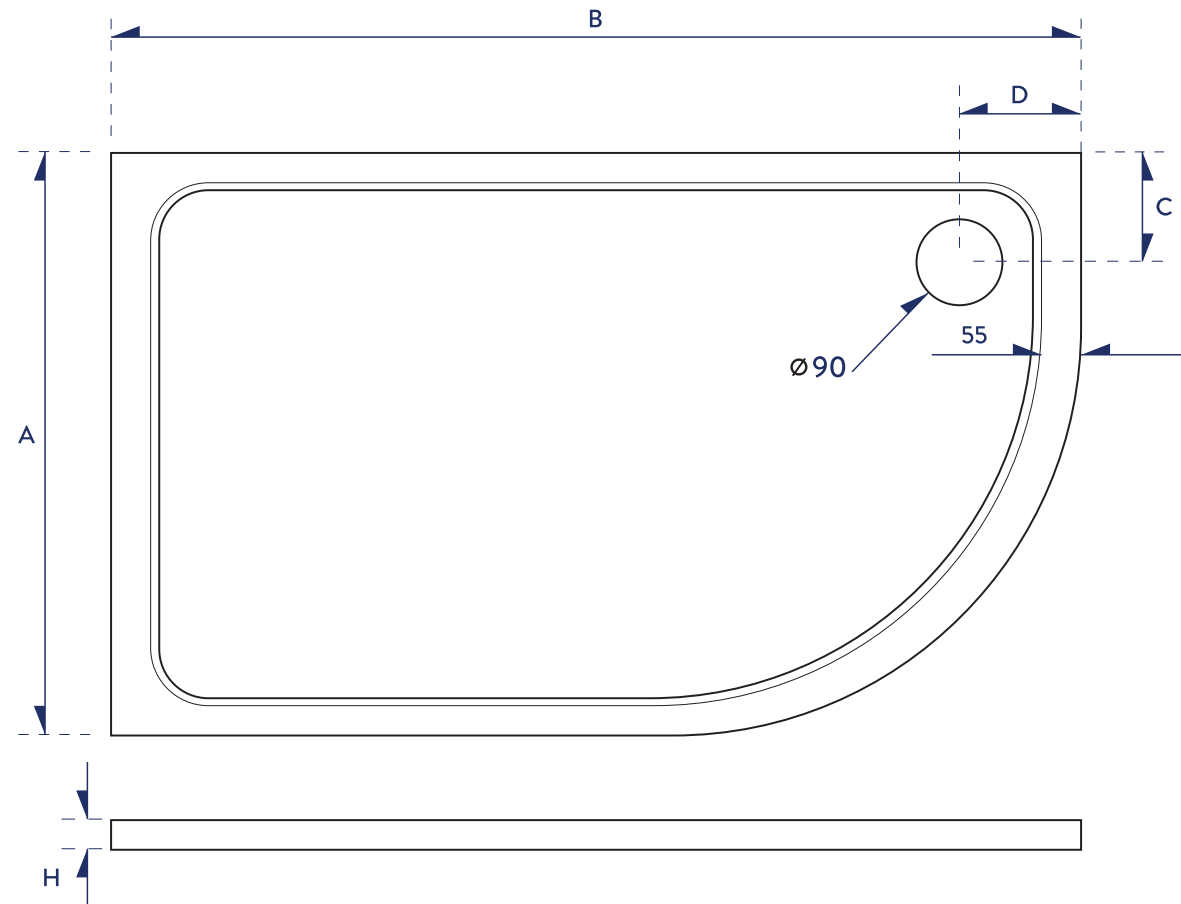

Code	Product Specification (mm)	A (mm)	B (mm)	C (mm)	D (mm)	H (mm)	Packaging Specification (mm)	Net Weight (kg)	Gross Weight (kg)
900-760-OFFRH-WTE	760*900*30	760	900	160	160	30	800*940*60	27	28