

## Installation instructions and cautions

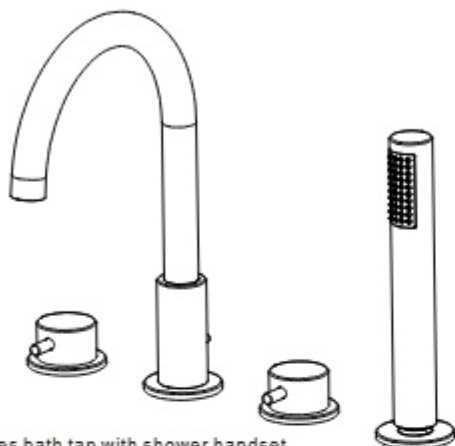

The instruction fits 4 holes bath tap with shower handset.

### Cautions

1. Clean the pipes before installation.
2. Check the pipes for breaks.
3. The pressure to work on the tap is within 0.05-1.0 MPa.
4. Water supply temperature maximum less than 90 degrees, suggested temperature less than 65 degrees.

### Cleaning instructions

1. It is recommended to clean with soft cotton cloth or sponge.
2. Do not use any aggressive liquids for cleaning, such as ammonia, decontaminated water, toilet bowl cleaner, etc.
3. Do not use metal or hard cleaning tools such as cleaning balls to wipe the surface of the filler.

### Mounting Dimensions

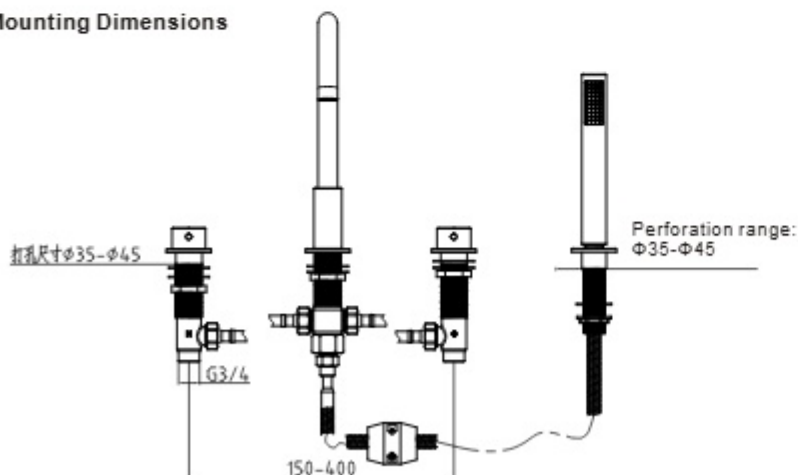

### Installation steps

#### 1. Installation of the tap

(1) Remove the nut(NO. 1), collar(NO. 2), O-ring(NO. 3), inlet body(NO. 4), O-ring(NO. 5), collar(NO. 6), nut(NO. 7), spacer(NO. 8) and rubber gasket(NO. 9) from the tap body.

(2) Install the tap body(NO. 11) through the mounted hole on the basin, attach the nut(NO. 7), spacer(NO. 8) and rubber gasket(NO. 9) on the tap body, then tighten the nut(NO. 7), and adjust the direction of the tap, ensure the tap body dose not shake.

(3) Attach the collar(NO. 6), O-ring(NO. 5) body(NO. 4), O-ring(NO. 3), collar(NO. 2), the nut(NO. 1) back on the tap body, and tighten the the nut(NO. 1) with wrench.

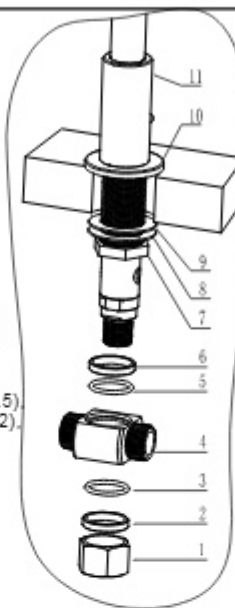

#### 2. Installation of the valve body

(1) Remove the handle(NO. 19) from the hand wheel, unscrew the screw(NO. 20) with Allen key, then remove the hand wheel(NO. 18), flange(NO. 17), and rubber gasket(NO. 16) from the valve body.

(2) Install the valve body(NO. 12) on the basin through the mounted holes from underneath the basin, attach the flange(NO. 17) and rubber gasket(NO. 16) to the valve body from the top of the basin, then tighten the nut(NO. 13) with wrench.

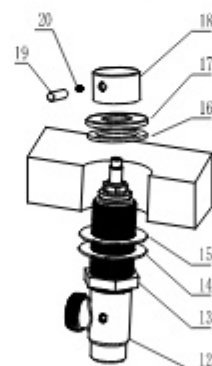

#### NOTE:

The cold water valve on the right, hot water valve on the left.

Adjust the switching direction of the valve body so that the valve is closed. When the valve is closed, install the handles as the direction shown on the right. Tighten the screw(NO. 20) of the hand wheel with Allen key, and install the handle(NO. 19) back to the hand wheel.

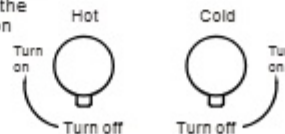

#### 3. Installation of the shower handset

(1) Remove the rubber gasket(NO. 23), nut(NO. 24) from the handset holder(NO. 22). Install the handset holder(NO. 22) through the hole on the basin, attach the rubber gasket(NO. 23) and nut(NO. 24) on the handset holder, tighten the nut to lock the holder.

(2) Connect the handset(NO. 21) with hose(NO. 25), pass the hose through the handset holder(NO. 22), place the handset on the holder.

(3) Install the adapter(NO. 27) on the hose(NO. 25) and install the rubber gasket(NO. 28) on the adapter.

(4) Remove the screw on the gravity block(NO. 26), install the gravity block on the hose(NO. 25), then tighten the screw on the gravity block.

#### Note:

The gravity block is mounted in the proper position on the hose according to the actual hose draw distance.

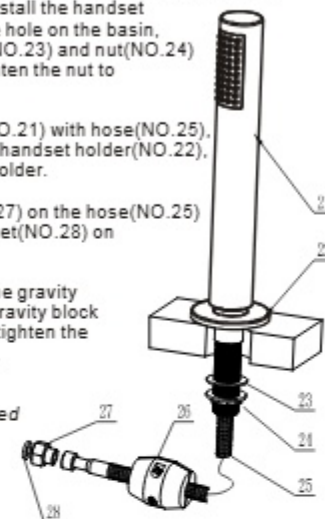

#### 4. Installation of the connection pipe

Connect the valve body with hose, the other side of the hose connect to the tap, after the connection of two valve body with the tap, connect the shower handset hose(NO. 30) with the tap, then tighten all the screws.

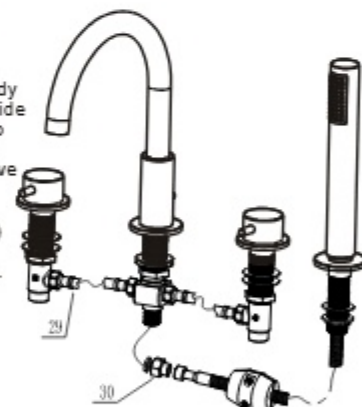

#### 5. Installation check

(1) After the installation is completed, check connected parts to see if they are firmly installed and the screws are locked.

(2) Open the water supply valve and check whether there is any leakage in each connection part.

(3) Remove the aerator(NO. 31) with specialized wrench, and remove the handset(NO. 21). Turn on the valve allow the water to run for one minute, flush the contaminants in the pipe.

(4) Turn off the valve, put the aerator(NO. 31) on and reinstall the handset.

