

# USER MANUAL

---

*Please read this manual before installing your product  
and keep for future reference.*

**Product name – AMBIENCE-MIRROR**

**Product code – AMBIENCE-MIRROR-80X60-  
MGREY**

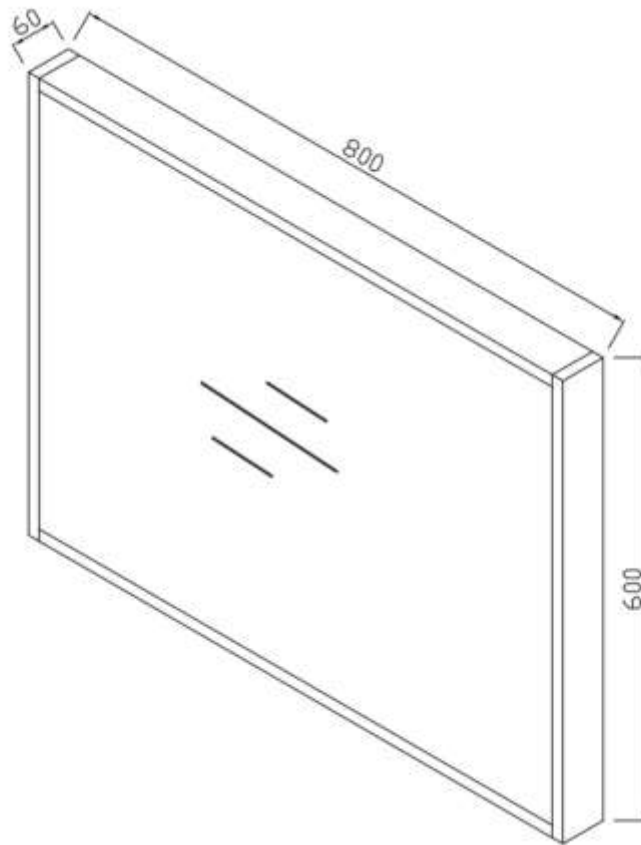

- **Single-person assembly**
- **We always recommend using professional tradespeople to install your product**

## Installation

1. Position the Mirror in a suitable location.
2. Carefully mark the position of the mirror using a soft pencil ensuring it is level. Remove the mirror and mark the mounting points. Please ensure that all marked mounting points accurately match up with the fixing points on the mirror.
3. Using a suitable drill bit, drill holes in the marked positions to a suitable depth. If drilling through tile, use a ceramic drill bit.
4. Insert wall plugs level with the surface of the wall. If fitting to a tiled surface, wall plugs should be inserted below the tile surface to avoid cracking. NB. For plasterboard walls, specialist fixings should be purchased, available from any DIY or hardware store.
6. Screw supplied fixings into wall plugs.
7. Hang the mirror in position.

## Installation Procedure

**Please carefully read the following instructions before installing**

- 1: Before installing the product, please carefully read the instructions and operate accordingly.
- 2: Before installing, please turn off the main power switch and ensure that it won't turn on.
- 3: The installation of this product requires that the staff has some electrical knowledge.
- 4: This mirror cabinet is heavy do not lift or install without help to avoid injury.

5: Before installing, please check whether the product is broken to avoid injury caused by broken glass

6: Do not clean the product surface with acid or alkaline cleaning agents, please use a damp cloth

## Packing List

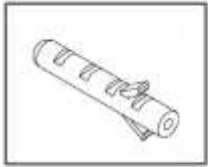

Expansion Plug



Screw M6

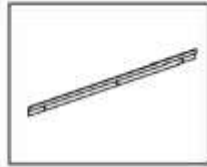

Aluminum Bar

## Installation Tools



Flexible rule



Spirit level

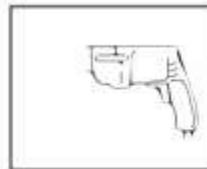

Churn Drill



Screwdriver

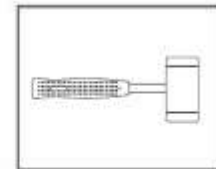

Hammer

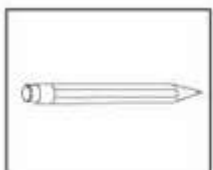

Pencil

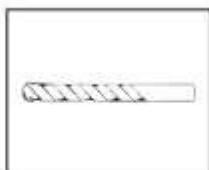

Drill Bit

## Installation Steps

1. Using tape measure and spirit level mark up your guides make sure it is level.
2. Using your drill, drill the holes.
3. Attach your brackets to the wall using your screwdriver.
4. Using the brackets on the back of the mirror. Line the brackets on the mirrors and the brackets on the wall up evenly.
5. Hook both brackets together and your mirror should be level.

## **Cleaning**

To maintain the surface of your product, wipe with a clean damp cloth and wipe dry, do not use any abrasive cleaning agents or materials. If any harsh chemicals come into contact with the surface of the product, rinse and wipe clean immediately.