

BRISTAN

Installation Instructions & User Guide

Please leave these instructions with the end user

ARM CTRD02 C (D5)

Specifications

Dynamic Water Pressure

Min: 0.2 bar Max: 5.0 bar



Maximum Static Pressure: 10.0 bar

Inlet Water Temperature

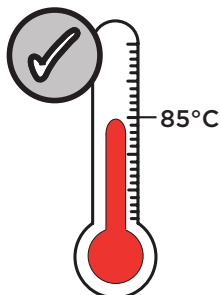

Maximum Hot 85°C

Inlet Connections

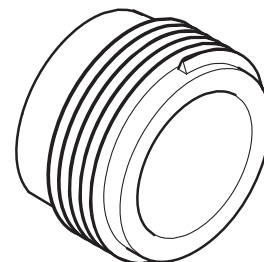

1/2" BSP

Pack Contents

Shroud x1



Wall Arm

x1

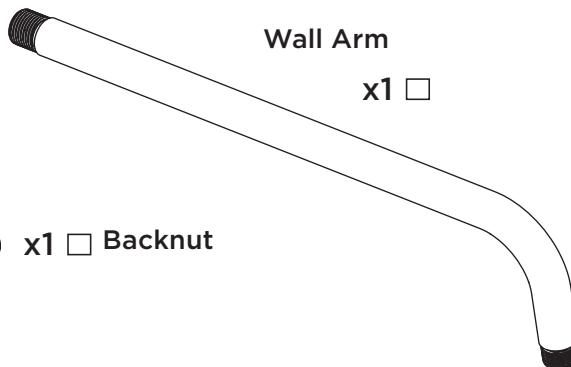

Locking Nut

x1



x1 Backnut

Tools Required for Installation



Pipe Cutter



Pencil

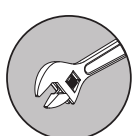

Adjustable Spanner



Drill

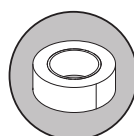

PTFE Tape

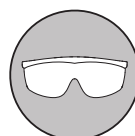

Safety Goggles

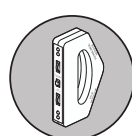

Electronic Detector

Prior to Installation

All products manufactured and supplied by Bristan are safe to use provided that they are installed, operated and receive regular maintenance in accordance with these instructions.

This product needs to be installed in accordance with, and meet the requirements of The Water Supply (Water Fittings) Regulations (Northern Ireland) 2009 and The Water Supply (Water Fittings) (Scotland) Byelaws 2014. For full Installation Requirements & Notes (IRN) please visit www.wrasapprovals.co.uk/approvals-directory

Isolation valves must be fitted to the inlet water supplies to ensure ease of future maintenance. Before installing this product the water supply must be thoroughly flushed in order to remove any swarf, solder etc. Full access must be made available for future maintenance/servicing purposes.

If power tools are used do not forget to: - Wear eye protection - Unplug equipment after use

This product must not be modified in any way as this will invalidate the guarantee.

Spare Parts



To replace any spare parts for your tap, why not scan the QR Code or visit www.bristan.com and search for your product.



Important

The images shown are for illustrative purposes only.

The product you have purchased may look different to those pictured in this booklet but will follow the same installation steps.

Your contents page will be specific to your product.

If you find your product or any of its components differ from those shown on the contents page, please contact our customer support.

Installation

Thread the arm through the wall with the shroud in place.

1

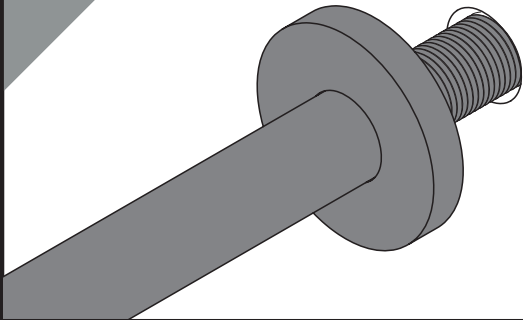

2

Secure the arm in position by tightening the locking nut and backnut.



3

Connect the outlet pipework to the shower arm using a suitable connector (not supplied).

The supply pipework to the shower valve must be rigid and secured in position with the use of pipe clamps.

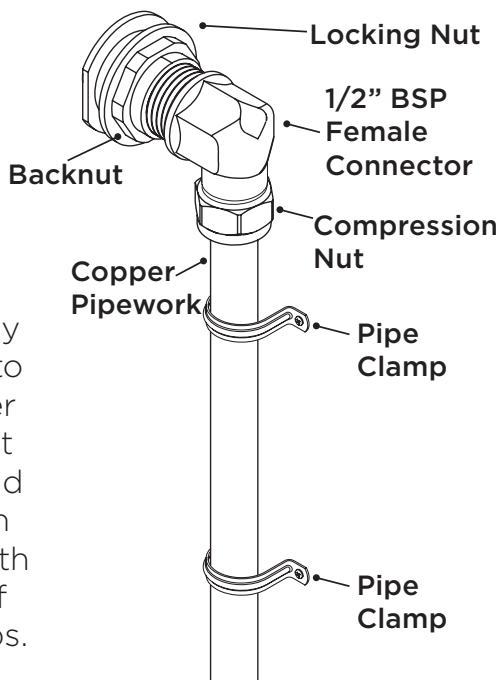

4

Screw your chosen shower rose onto the shower arm by **HAND ONLY**. Ensure the sealing washer is used where supplied. Turn on the water supply and check all joints and connections for any leaks.

Typical Installation

* - not supplied
~ - check pack contents if supplied

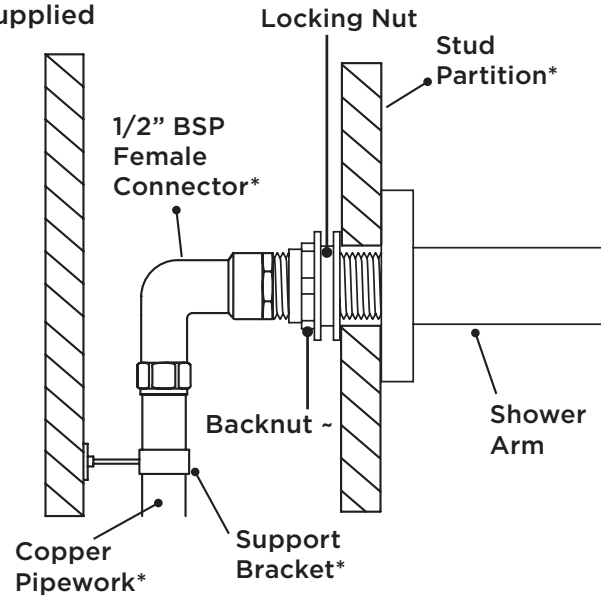

Alternative Installation

1



Use PTFE tape that is compliant with UK Water Regulations around the thread.

2

Make a sufficient hole in the desired location to feed through the threaded pipe on the wall arm.

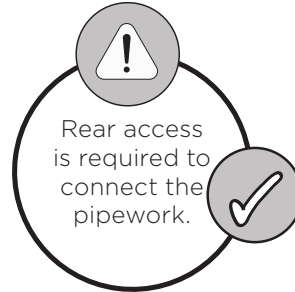

3

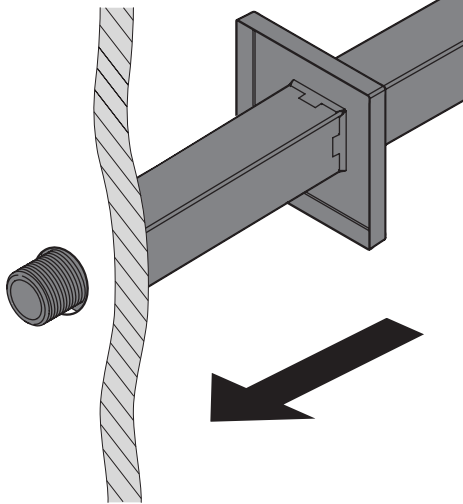

Push the shroud into position.

4

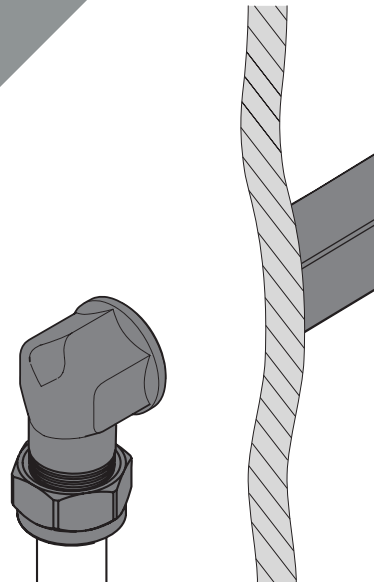

Use a tap connector (not included) to connect to the pipework. Connect the outlet pipework to your desired shower (not supplied) and to your wall arm.

5

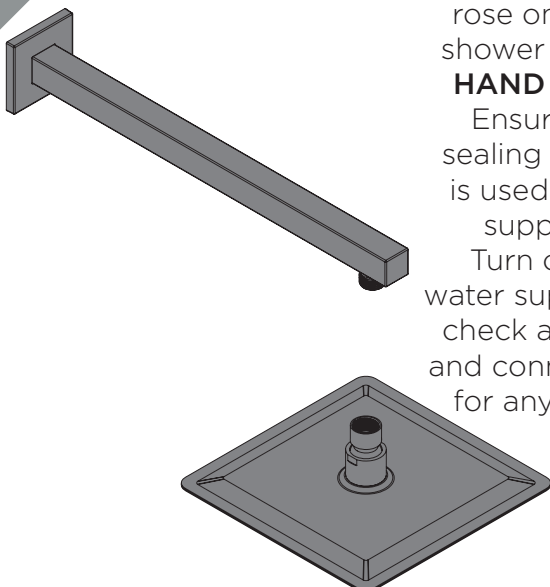

Screw your chosen shower rose onto the shower arm by **HAND ONLY**. Ensure the sealing washer is used where supplied. Turn on the water supply and check all joints and connections for any leaks.

General Cleaning

Bristan products are made from premium materials, with hand polished, electroplated, PVD or EPD finishes.

Your product should be regularly cleaned with warm water, a mild pH-neutral liquid soap, and polished with a soft cloth. Any residues from soap, toothpaste, shampoos and shower gels can cause blemishes if not rinsed off straight after use.

Household bleaches and cleaners contain harsh chemicals and may damage the surface finish. Avoid using abrasive cloths, scouring pads, scrub sponges, steel wool or anything similar.

Notes

Please use this space for any notes you or your installer may have regarding the installation/plumbing of this product.

Contact Us

BRISTAN

Bristan Group Ltd.

UK: Bristan Group, B78 1SG.

EU: Masco Europe S.à.r.l.
14 Rue Strachen
6933 Mensdorf
Luxembourg

Customer Service: +44330 026 6273

Web: www.bristan.com

Email: enquire@bristan.com

A Masco Company

Our Guarantee

At Bristan, we want to make things as easy as possible for our customers. That's why we offer solid guarantees on all our products, effective from the date of purchase, to give you peace of mind.

To start your free guarantee simply scan the QR code and register your product.
Alternatively visit www.bristan.com/register.

For any other queries, please call our Customer Service on 0330 026 6273 where our expert team of advisors will be able to offer you any help and advice.

For full guarantee terms and conditions visit www.bristan.com/service-centre/guarantees.

