

ARNAGE TOWEL RAIL INSTALLATION GUIDE

Please read these instructions carefully before installation and operation







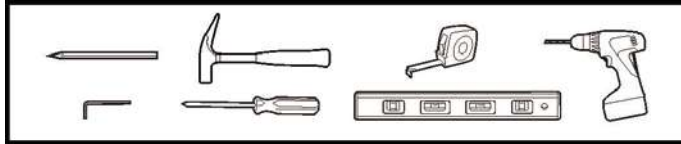

- 1.This Towel Rail is not intended for use by persons (including children) with reduced physical, sensory or mental capabilities, or lack of experience and knowledge, unless they have been given supervision or instruction concerning use of the Towel Rail by a person responsible for their safety.
- 2.In order to avoid a hazard, this Towel Rail must be installed so that the bottom rail is at least 600mm above the floor.
- 3.This Towel Rail is intended to warm and dry towels and therefore is hot to the touch.
- 4.The towel rail is to be installed so that switches and other controls cannot be touched by a person in the bath or shower.
- 5.To avoid a hazard this towel rail must not be used to hold towels or any other articles that have been in contact with oil, petroleum based products or dry cleaning fluids.
- 6.Use this Towel Rail only with the voltage specified on the rating label.
- 7.Do not immerse in liquid or allow liquid to run into the interior of the Towel Rail. Indoor use only.
- 8.Do not operate this towel rail if damaged or after the Towel Rail malfunctions or has been dropped or damaged in any manner. Return to a qualified electrical person for examination, electrical service or repair.
- 9.Use this Towel Rail only as described in this manual. Any other use is not recommended by the manufacturer and may cause fire, electrical shock or injury.
10. Do not use this Towel Rail in a window as rain may cause electric shock.

TOOLS REQUIRED

- Pencil
- Hammer
- Measuring Tape
- Spirit level
- Electric drill
- Screw driver
- Hex key



ACCESSORIES

Wall anchors x8		Applied models	
Screws M6*45 x8		DE-ARG0805	DE-ARG1205
Screw M6*18 x1			
Screw M6*20 x4			
Decorative cap x4			
Mounting seat x4			
Mounting leg single hole x3			
Mounting leg two holes x1			

Code	Size	Power	Voltage
DE-ARG0805	800*500MM	90W	220-240VAC,50HZ
DE-ARG1205	1200*500CM	130W	220-240VAC,50HZ

Please follow the below installation steps to complete the towel rail installation

Step 1

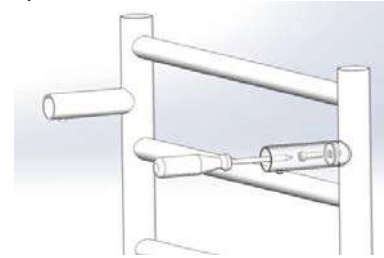

Fix 3 mounting single hole tubes to the threaded holes on the vertical bar, Screw down the mounting screw with a screwdriver.

Step 2

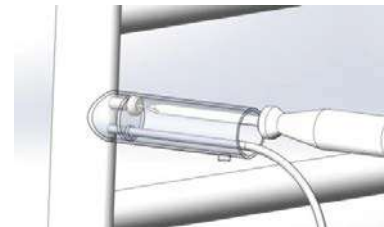

Guide the electrical cord through the electrical connection two holes mounting tube and use the short mounting screw to tighten the electrical connection mounting tube to the vertical bar.

Step 3

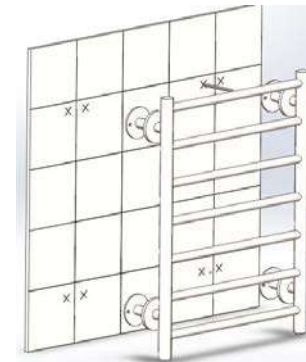

Use a measuring tape to measure the distance between the center points of each wall bracket tube, and mark the installation holes by pencil.

Step 4

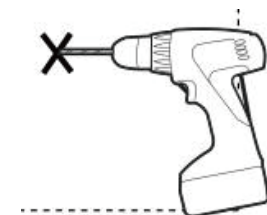

Make the holes with an electric driller

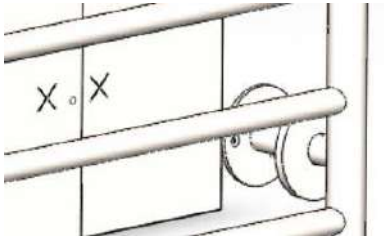

Be sure to drill a hole for the core cable going from the leg to the wall on the right lower mounting leg.

Step 5

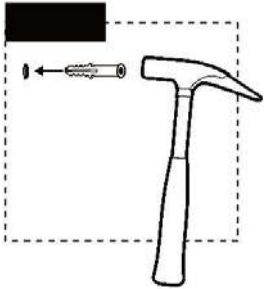

Use a hammer to knock plastic wall anchor into wall completely

Step 6

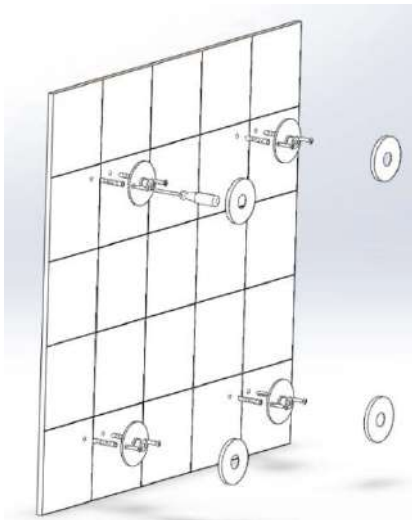

Insert long screw through mounting seat, then screw into the plastic wall anchor with a screw driver. And put the decorative cap against the mounting seat

Step 7

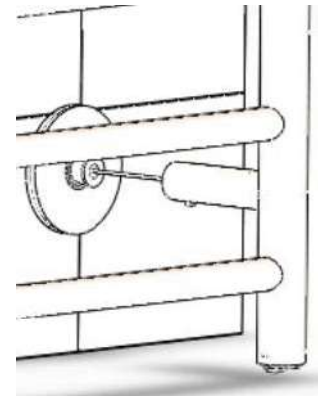

Connect the core wire from the leg to the power wire inside the wall

Step 8

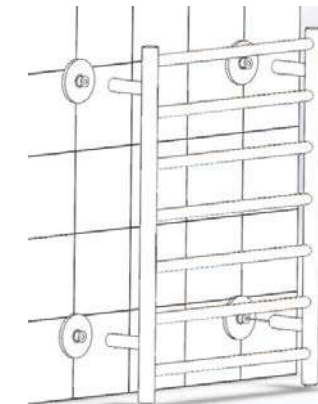

Lie the towel warmer against the mounting seat fixed on the wall.

Step 9

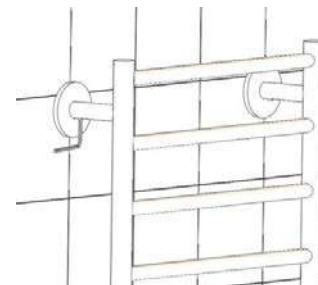

Install the hex screws into the hole of all the tubes using the allen wrench and fix the towel warmer tube onto the mounting bracket.

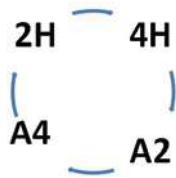

How to use the TIMER on the towel rail?



TIMER working mode :

- 1) Constant 24 hours ON
- 2) 2H: 2 hours ON, stop working automatically after 2 hours
- 3) 4H: 4 hours ON, stop working automatically after 2 hours
- 4) A2 (Automatic working mode), 2 hours ON, 2 hours OFF, then 2 hours ON and 2 hours OFF automatically working as circulation way.
- 5) A4 (Automatic working mode), 4 hours ON, 4 hours OFF, then 4 hours ON and 4 hours OFF automatically working as circulation way.

Only Pressing the right button  on the display, now it is power on and simultaneously it will be working for constant 24 hours, no matter what number showing on the digital screen.

If you want to use the boost TIMER working by hours, then press the left button , you can select **2H- 4H- A2- A4** (as above description), a blue cursor  between two words on the display will flash to indicate the rail is beginning to work under current selected TIMING mode.