



SCUDO
BEAUTIFUL BATHROOMS

AURA

LED Mirror Range



Technical Drawings & FAQ Data Sheets



SCUDO
BEAUTIFUL BATHROOMS

AURA

AURA LED Mirror 500x700mm

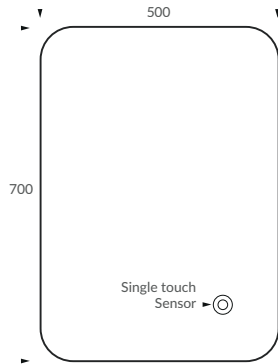

FRONT VIEW

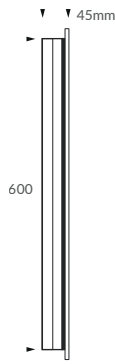

SIDE VIEW

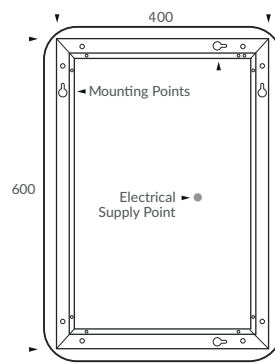

BACK VIEW

AURA LED Mirror 600x800mm

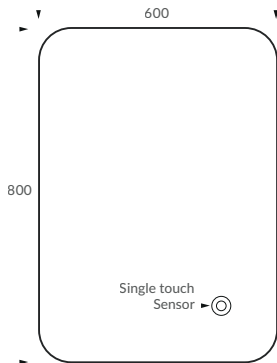

FRONT VIEW

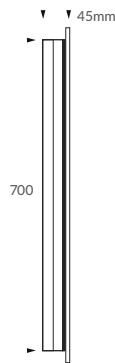

SIDE VIEW

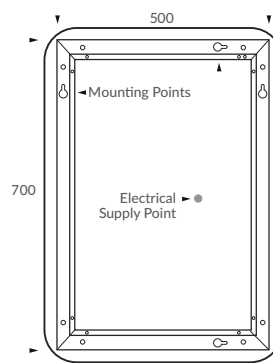

BACK VIEW

AURA LED Mirror 1200x600mm

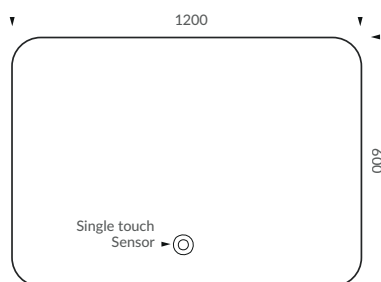

FRONT VIEW

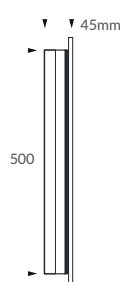

SIDE VIEW

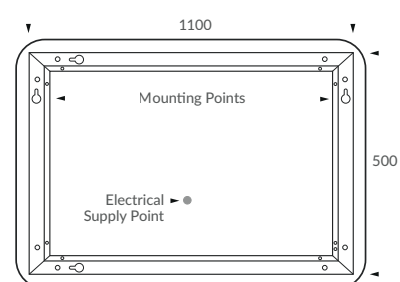

BACK VIEW



SCUDO
BEAUTIFUL BATHROOMS

AURA

AURA Technical Details Safety & Installation Notes

Heated Demister Pad

All of our mirrors come with heated demister pads enabling you to use the mirrors in steamy bathrooms. The pads heat the mirror to above room temperature which stops mist appearing on the mirror.

Touch Sensor On/Off Switch

All Aura Scudo mirrors are built using touch sensor on/off switches with memory function. Landscape & Portrait Mounting

All of our mirrors can be hung portrait or landscape (excluding LED-MIRROR003). By doing this the on/off switch would be moved from the bottom of the mirror to the side of the mirror.

Safety Glass

5mm thick mirror.

Electrical Safety Information

SCUDO recommends that all electrical bathroom products should only be fitted by a qualified - Part P registered electrician in accordance with the current IEE Regulations.

Ensure the Mains supply is switched off before attempting installation.

Before drilling ensure there are no hidden cables or pipes in the wall..

Installation Information

SCUDO recommends that you receive the product before commencing with installation is attempted as all sizes and measurements are approximate.

SCUDO try and ensure all measurements are as accurate as possible. In the interest of continued product development, SCUDO reserves the right to alter specifications as necessary. E & OE.



SCUDO
BEAUTIFUL BATHROOMS

AURA

AURA Safety & Installation Notes

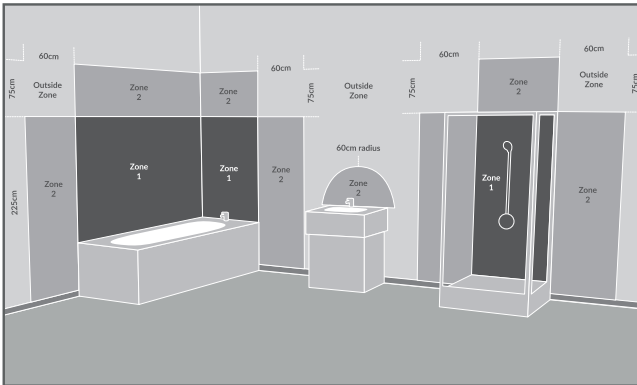

These products are suitable for installation in zones: 2 & Outside Zone

All installations must comply with guidelines which are based on a zonal concept. The diagram above illustrates this concept and must be followed to ensure the safe installation of Electrical appliances in the bathroom. These regulations apply to domestic installations only. Installations must be made in accordance with the current IEE wiring regulations and relevant building regulations. SCUDO recommends that all electrical bathroom products should only be fitted by a suitably qualified, Part P registered electrician.

Installation

1. Position the Mirror in a suitable location according to the Zonal diagram above, ensuring that the domestic electrical mains supply is within reach of the electrical entry point of the product.
2. Carefully mark the position of the mirror using a soft pencil ensuring it is level. Remove the mirror and mark the mounting points. Please ensure that all marked mounting points accurately match up with the fixing points on the mirror.
3. Using a suitable drill bit, drill holes in the marked positions to a suitable depth. If drilling through tile, use a ceramic drill bit.
4. Insert wall plugs level with the surface of the wall. If fitting to a tiled surface, wall plugs should be inserted below the tile surface to avoid cracking. NB. For plasterboard walls, specialist fixings should be purchased, available from any DIY or hardware store.
5. Screw supplied fixings into wall plugs.
6. Ensure the domestic electrical mains supply to which the mirror is being connected is turned off. Connect the domestic mains supply to the terminal box according to the wiring diagram.
7. Hang the mirror in position.
8. Switch the domestic electrical mains supply for the mirror back on.

Operation Instructions

To turn the mirror light ON, hold the Sensor to change the colour from 3000k to 6400k.
The Heated Pad is only on when the Mirror is illuminated.

Aura LED Mirrors

Aura LED Mirror 500 x 700

Aura LED Mirror 600 x 800

AuraLED Mirror 1200 x 600

Thankyou for purchasing this SCUDO Product.

Please read through these instructions thoroughly and refer back to them during installation to ensure that your product is fitted safely and that it retains it's high quality finish.

Please retain this leaflet for future reference.

Before installation, ensure the domestic electrical mains supply to the mirror is to be connected to is switched off. Before drilling, ensure that there are no hidden cables or pipes in the wall.

Mounting Points Diagram

Aura 5x7
Aura 6x8
Aura 12x6

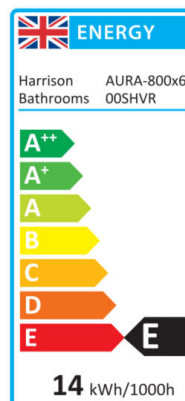
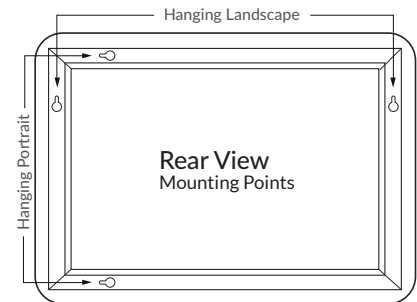

Care Instructions

Do not use abrasives or solvents when cleaning this product. Wipe off all water spillages as soon as possible using a soft, damp cloth

Aftercare Service

In the unlikely event that this product should fail please contact SCUDO customer service on the contact number.



SCUDO
BEAUTIFUL BATHROOMS

AURA

AURA Installation Instructions

General information

This product conforms to U.K safety standards and must be installed in accordance with current IEE Wiring regulations and Building regulations (PART P).

This product must be earthed, and should not be connected to an unearthed circuit. If there are only two wires coming from your power supply it means that this fitting can be wired to an unearthed circuit.

Ensure that connections are turned off at the consumer unit or fuse board before installing or carrying out any maintenance.

This product is for indoor use only.

This product is IP44 rated and can be installed in Bathroom zone 2 (Defined by the IEE wiring regulations) and beyond. See bathroom diagram (A)

Replace failed lamps immediately. Allow the Glass lamp and fitting to cool before replacing the lamp.

Important

When working at heights, please use a suitable platform to work from.

Please Note: For the new installations, check for any electrical cables or pipe work (gas / water) in the vicinity of the intended mounting point before proceeding with the installation.

Ensure that the fixing location is able to take the weight of the complete fitting

Wear suitable eye protection when drilling. Be careful when using power tools near water.

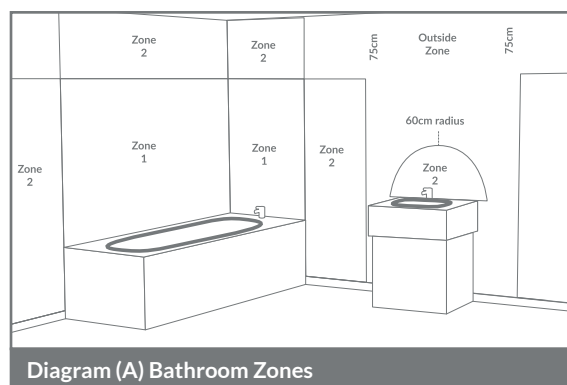

Do NOT strike the mirror glass with hard or pointed items. It is recommended that the product is cleaned with a soft dry and non abrasive cleaning cloth. DO NOT use abrasive materials on any type of finished surface. Do not allow moisture to come into contact with the working electrical components.

Compliance: This product complies with the following safety standards:

BS EN 60598-1: 2008+A11: 2009, EN60898-2-1: 1989



SCUDO
BEAUTIFUL BATHROOMS

AURA

AURA Installation Procedure

Notes: To ensure the normal use of products, it is required you set out wires as per the regulations of IEE at the installation places. The Products are only applicable to being installed on the indoor solid wall. The installation must be carried out by a professional electrician and wrong installation may lead to product damage and personal injury.

Installation Tools

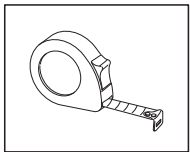

Flexible rule

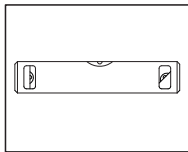

Spirit level

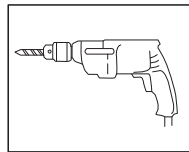

Churn Drill

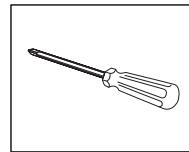

Screwdriver

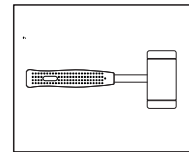

Hammer

1. Make certain the wall is solid, and use the flexible rule to measure the distance between two hardy holes on the mirror frame ("a" and "b" in fig 2).
2. Use the flexible rule to measure the centre distance between two hardy holes on the wall ("a" and "b" in fig 2) and mark them out with a pencil.
3. Choose the churn drill with an appropriate drill bit to make two holes at the marked places, and use a special ceramic drill if the wall surface is made of ceramic tiles.
4. Use the hammer to strike an expansion rubber plug into the holes on the wall, and then use the screwdriver to tighten the screws into the holes (Exposure for 8 - 12mm)
5. Switch off the power, and then use a terminal block to connect the three-core exposed wires with those reserved on the wall (see details in Fig 3)
6. Hang the product on the screw crossing two hardy holes to fix it.
7. Finally switch on the power, and then touch the switch sign (Fig 1) with a finger on the lens to test the products.

Operation Instruction: To turn the mirror light ON, hold the Sensor to change the light colour from 6400k - 3000k.

Note this product has power memory function. The mirror can keep the colour temperature before the power off.

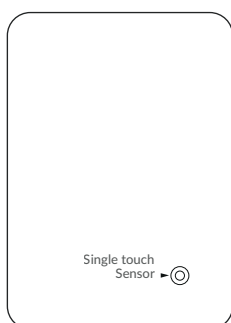

Fig. 1

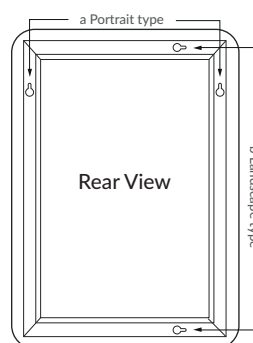

Fig. 2



SCUDO
BEAUTIFUL BATHROOMS

AURA

AURA Wiring Diagram for Input

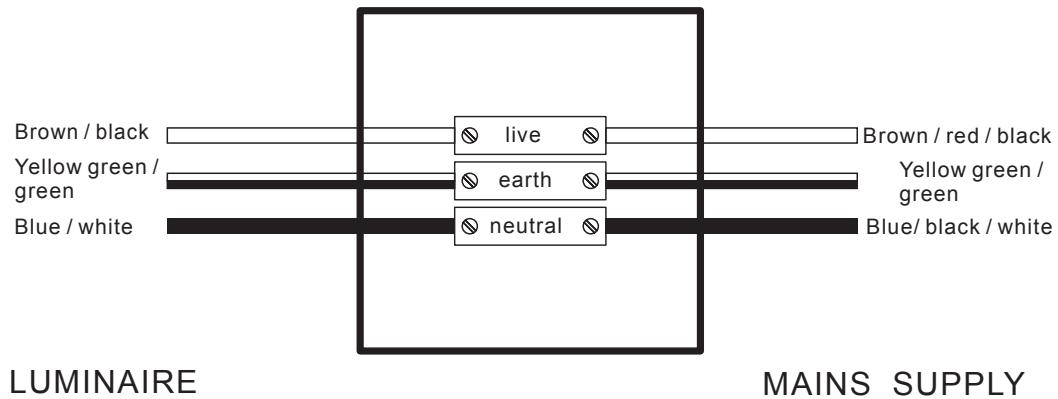

AURA Schematic Diagram

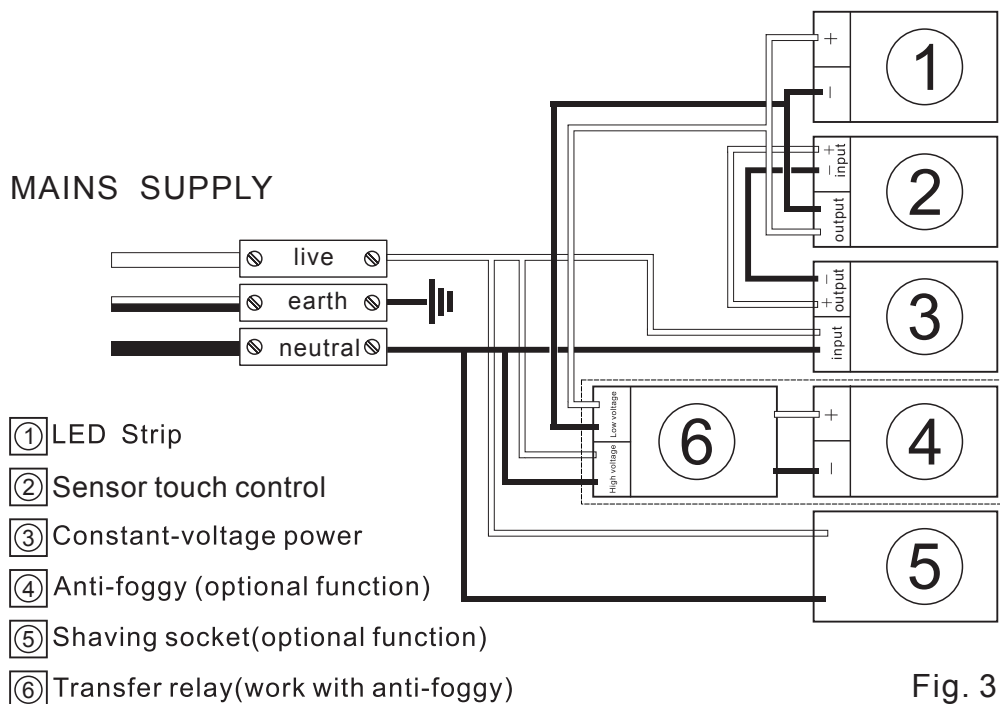

6. Waste Electrical & Electronic Equipment Regulations (WEEE) requires that any of our products showing this mark (left) must not be disposed of with other household or commercial waste. SCUDO does not levy any WEEE disposal charges to its customers for affected WEEE related products. To prevent possible harm to the environment or human health from uncontrolled waste disposal, please separate any such product from other waste types and recycle it responsibly at your local facilities. Check with your Local Authority, Recycling Center or retailer for recycling advice.



SCUDO
BEAUTIFUL BATHROOMS

AURA

AURA LED Mirror Range FAQ's

	AURA LED 500x700	AURA LED 600x800	AURA LED 1200x600
A. Nett Weight (kg)	/	/	/
B. Light Source	LED	LED	LED
C. Light source average lightspan	3k (hrs)	3k (hrs)	3k (hrs)
D. Total Rated Wattage (W)	37w	53w	61w
E. Lumens (Lm)	2600Lm	3120Lm	4160Lm
F. Kelvins (K)	3000 / 6400k	3000 / 6400k	3000 / 6400k
G. Is the Mirror Dimmable	No	No	No
H. Energy Rating	E	E	E
I. What orientation can the mirror be hung in	Portrait/Landscape	Portrait/Landscape	Portrait/Landscape
J. Is the heated pad only on when the mirror is illuminated	Yes	Yes	Yes
K. Does the mirror require an earth connection	Yes	Yes	Yes
L. Can I bypass the sensor so the mirror comes on with the main room light	No	No	No
M. Is it cool white or warm white illumination	/	/	/
N. How long is the warranty	2Yrs	2Yrs	2Yrs

Electrical Safety Information

SCUDO recommends that all Electrical Bathroom products should only be fitted by a suitably qualified, Part P registered electrician in accordance with current IEE Regulations.

Ensure mains power supply is switched off before starting installation.

Before drilling, ensure there are no hidden cables or pipes in the wall.

SCUDO recommends you receive the product before commencing with installation as all sizes and measurements are approximate.

SCUDO Try and ensure all measurements are as accurate as possible.

In the interest of our continuous product development, SCUDO reserves the right to alter specification as necessary. E & OE.



SCUDO
BEAUTIFUL BATHROOMS

Telephone: 0844 324 9061

Email: sales@scudo.co.uk

OnLine: www.scudo.co.uk

SCUDO is a trading name of Harrison Bathrooms LTD. Prospect Works, Keighley, West Yorkshire, BD21 4LA