

PRODUCT DATA SHEET

Double Ended Square Bath 1800x800mm

Product Code: BATH-SSQDE1800X800-D



SCUDO
BEAUTIFUL BATHROOMS

0330 124 7290

sales@scudo.co.uk - www.scudo.co.uk

Scudo is the trading name of Harrison Bathrooms Ltd. Whilst we endeavour to ensure that the product information is accurate we accept no liability for any information given. All images are for illustration purposes only. Product images and specification are subject to change. Measurement are in millimetres and are nominal.

Product Measurements

Product Weight:	22.48kg
Product Width:	800mm
Product Height:	1800mm
Product Depth:	400mm
Product Length:	N/A

Product Transportation

Barcode:	5060500643362
Country of Origin:	Egypt
Comodity Code:	3922100000

Primary Packed Measurements

Packaged Weight:	23kg
Packaged Length:	1800mm
Packaged Width:	800mm
Packaged Height:	400mm

Packaging Weight

Card:	0.5kg
Paper:	N/A
Wood:	N/A
Plastic:	0.04kg

General Information

Construction Material:	Acrylic
Installation Type:	Wall Mounted
Colour / Finish:	Gloss White

Bath Attributes

Bath Water Capacity (Litres):	152
Bath Water Capacity (m3):	0.152
Shape:	Double Ended Square
Handed:	Both
Bath Feet Included:	Yes
Supplied with Tap Holes:	No
Height Overflow/Soak Depth:	280mm
Internal Length Base (mm):	1155mm
Internal Width/Depth Base:	450mm
Internal Height:	380mm
Supplied with Front Panel :	No
Supplied with End Panel:	No
Compatible Panel Part Code:	All

Compliance DOP

HBDOC076 / HBDOC077

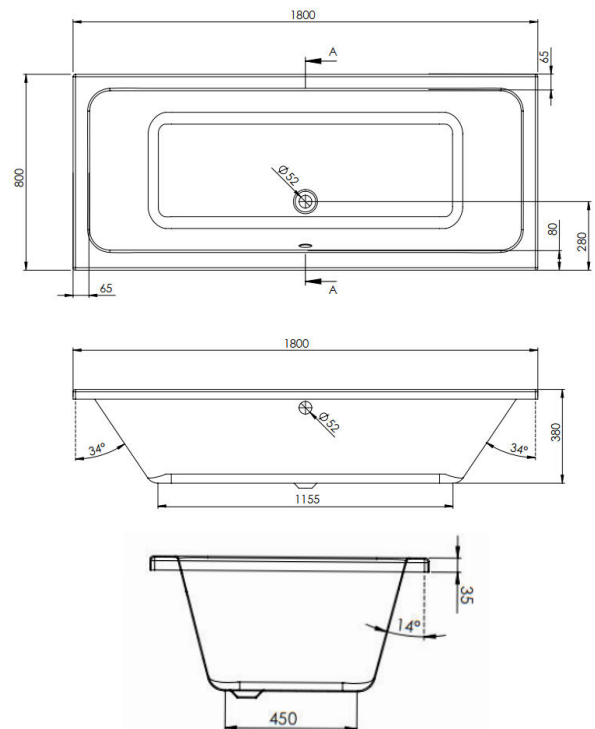

Dimensions
(measurements in mm)



LIFETIME GUARANTEE

We are confident in our products and we want our customer to be, we proudly give a lifetime guarantee on our taps and showers, further details can be found on our website