

Sales Code: BC417DL

Description: Wall Mount 3Th Basin Tap Dome Lever

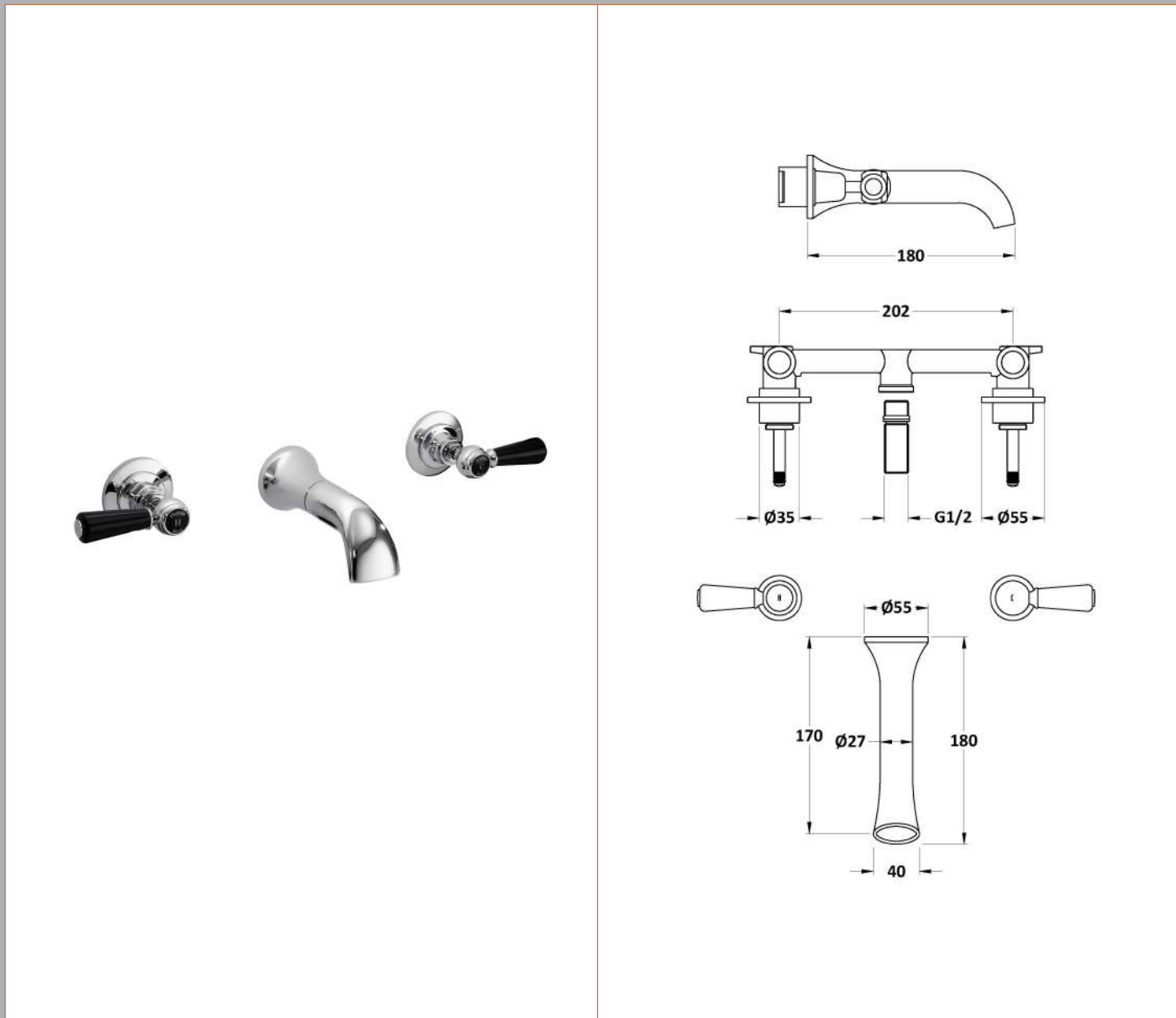

Product Dimensions

Height (mm):	55
Width (mm):	
Depth (mm):	180
Length (mm):	
Nett Weight (kg):	2

Packaging Dimensions

Height (mm):	65
Width (mm):	350
Depth (mm):	213
Gross Weight (kg):	2

Packaging Data

Box Colour:	White Cardboard Box
Box Qty:	1
Label Size:	100 x 50
Label Colour:	White Label
Label Qty:	1

Outer Box Dimensions (If Applicable)

Height (mm):	
Width (mm):	
Depth (mm):	
Length (mm):	
Gross Weight (kg):	
Barcode:	5056211853282

Product Details

Country of Origin:	China
Fitting Instruction:	No
Product Material:	Brass
Control Type:	Manual
Waste Included:	Waste Not Included
Waste Type:	Not Applicable
WRAS Approval:	No
Approval No:	N/A
Valve/Cartridge Type:	1/4 Turn Ceramic Disc
Colour/Finish:	Chrome
Mount Type:	Wall
Operating Pressure (bar):	0.1
Flow Rates: (Litres Per Min)	0.1 bar: 8 0.5 bar: 19.3 1 bar: 27.5 2 bar: 39.4 3 bar: 47.8
Pipe Size:	15 mm
Pipe Centres:	N/A