

Sales Code: BIN770F

Description: Binsey High Rise Mono Basin Mixer

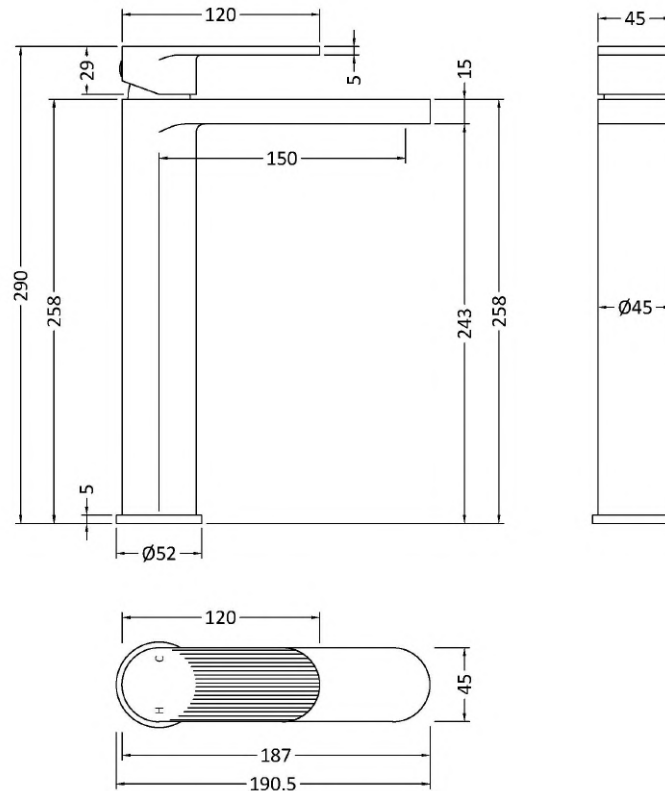

Product Dimensions

Height (mm):	290
Width (mm):	52
Depth (mm):	190
Length (mm):	
Nett Weight (kg):	2.28

Packaging Dimensions

Height (mm):	95
Width (mm):	265
Depth (mm):	325
Gross Weight (kg):	2.28

Packaging Data

Box Colour:	White Cardboard Box
Box Qty:	1
Label Size:	100 x 50
Label Colour:	White Label
Label Qty:	1

Outer Box Dimensions (If Applicable)

Height (mm):	500
Width (mm):	500
Depth (mm):	300
Length (mm):	
Gross Weight (kg):	
Barcode:	5056678478684

Product Details

Country of Origin:	China
Fitting Instruction:	No
Product Material:	Brass
Control Type:	Manual
Waste Included:	Waste Included
Waste Type:	Push Button
WRAS Approval: Yes	Approval No: 250702009
Valve/Cartridge Type:	Single Lever Cartridge
Colour/Finish:	Chrome
Mount Type:	Deck
Operating Pressure (bar):	0.2
Flow Rates: (Litres Per Min)	0.1 bar: 2.3 0.5 bar: 7.4 1 bar: 11 2 bar: 15.9 3 bar: 19.8
Pipe Size:	1/2"
Pipe Centres:	N/A