

CAP BAS C

CAPRI Tap Range Capri Basin Mixer with Pop-Up Waste Chrome



Specification

Product Type:	Bathroom Tap
Main Construction Material:	Brass
Mount Type:	Deck
Handle Type:	Lever
Connection Inlet:	M1 x 15mm flexible connection pipes
Connection Outlet:	M20 Flow Straightener
Number of Tap Holes:	1
Valve/Cartridge Type:	35mm Ceramic Disc Cartridge
Plumbing System Requirements:	Suitable for all plumbing systems
Minimum Dynamic Pressure (bar):	0.3 bar
Maximum Dynamic Pressure (bar):	5.0 bar
Maximum Hot Water Temperature °C:	65°C
Maximum Static Pressure (bar):	10 bar
Flow Type:	Single
Isolation Included:	No

Features:

- Long life ceramic cartridge for added durability and ease of use
- Metal fixing nut for added durability
- Flexible tails included
- Pop-up waste included

Product Certifications:



WRAS Certificate No: 2003908
WRAS Expiry Date: 31/03/2025



For more products, visit our website:
<http://www.bristan.com>



Dimensions (measurements in mm)

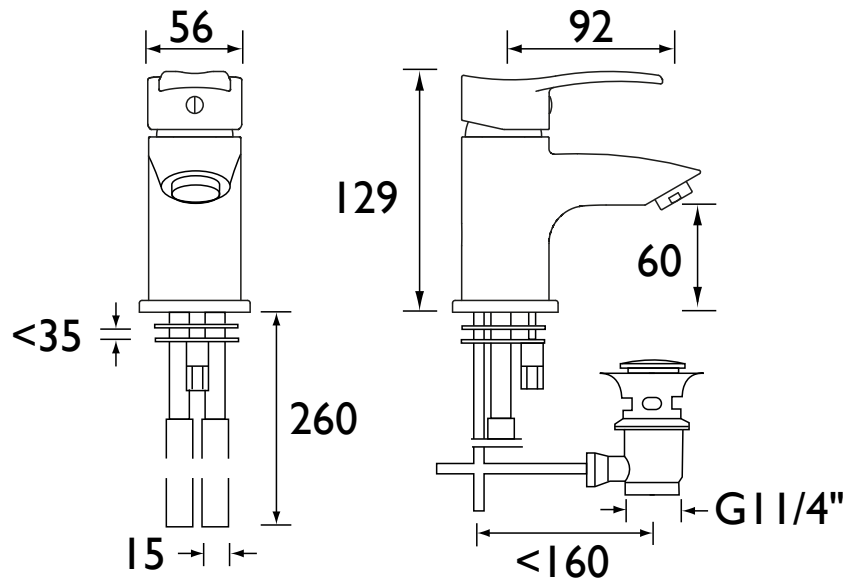

Flow Rates (l/min)

System Pressure (bar)	0.3	0.5	1	2	3	5
CAP BAS C (mixed)	5	5	5	5	5	5

TECHNICAL DATA SHEET



BRISTAN

D13