

Installation Instruction

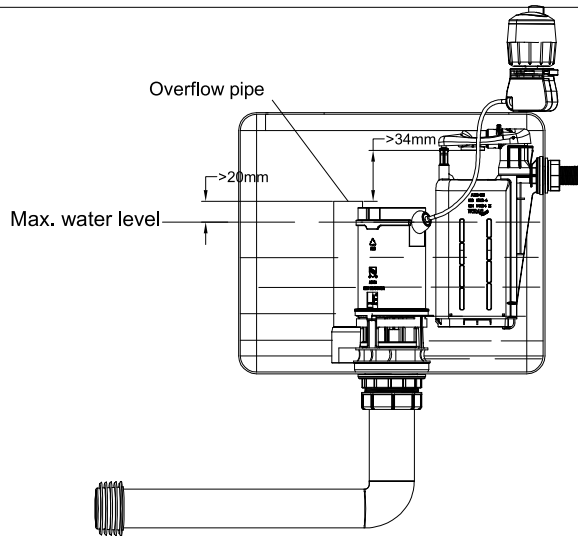

INSTRUCTION

1. Please read carefully the following instruction. In order to avoid injuring body or damaging equipment, please install the equipment following the instruction step by step.
2. The instructions are complied according to the up-to-date production information. we reserve the rights to make the changes about specifications, packaging and sullying without prior notice.
3. When valve installed, the point of discharge to the overflow pipe must be greater than 34mm. The water level to the overflow pipe must be greater than 20mm.
4. We shall not be responsible for any failure of using any parts from other companies.
5. Water temperature: 2°C-23°C
6. Water pressure: 0.01Mpa-1Mpa.

Warning

DO NOT USE OR DROP ANY CHLORINE OR ANY CHEMICAL RELATED COMPONENTS. USE OF SUCH PRODUCTS WILL (1) RESULT IN DAMAGE TO CISTERN COMPONENTS AND MAY CAUSE FLOODING AND PROPERTY DAMAGE AND (2) VOID WARRANTY. DO NOT OVERTIGHTEN OR CISTERN/BOWL MAY CRACK.

1. Water level adjustment

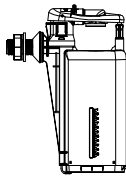

Please check the equipment first and make sure the equipment is no breakage and missing parts

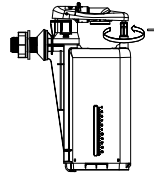

By rotating the blue screw, the water level increases when rotating clockwise and decreases when rotating counterclockwise

2. Fill valve installation

①

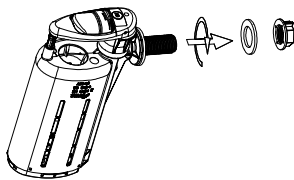

Remove the hex nut and nut collar from fill valve .Don't remove the seal !!!

②

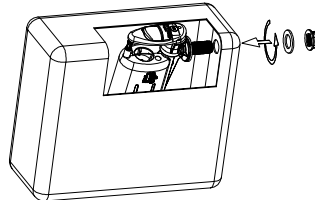

Insert the fill valve into the water tank.Screw on the nut collar and hex nut properly.

③

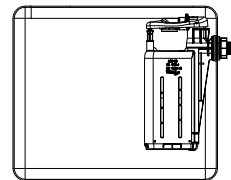

3. Water flush level adjustment

FULL ADJUSTOR

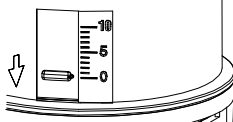

When blue slide with full adjustment is down,more water drains out of the tank.Vice verse, blue slide up=less water drains.

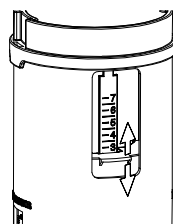

When white float with half adjustment is up,less water drains out of the tank.Vice verse,blue slide down=more water drains.

HALF ADJUSTOR

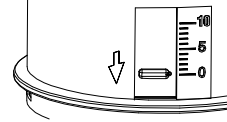

Adjust blue slide with half adjustment to make the water level lower when the white float with half adjustment on the bottom.blue slide up=less water drains.

4. Flush valve installation

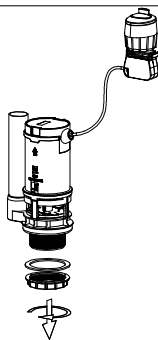

Remove the nut and nut collar from flush valve base.Don't remove the seal !!!

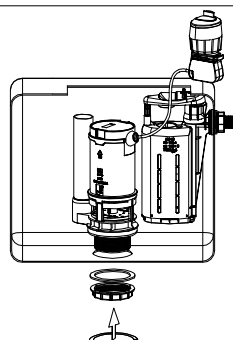

Insert the flush valve's base into the water tank.Screw on the nut collar and nut properly.

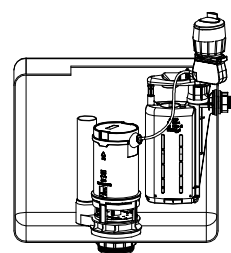

5. Button installation for side ceramic hole

Full
Half

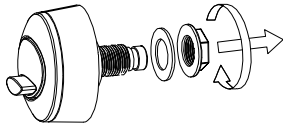

Unscrew the nut from the button body and take off the seal.

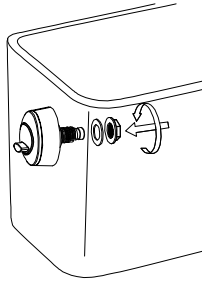

Insert the button into the hole on the water tank. Put on the seal and screw the nut.

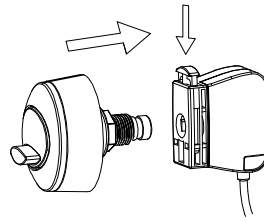

Push in the spring lock (a) which is on the control box and then insert button (b) into the control box.

6. Button installation for top ceramic hole

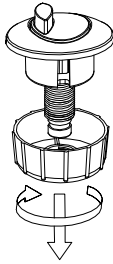

Unscrew the nut .

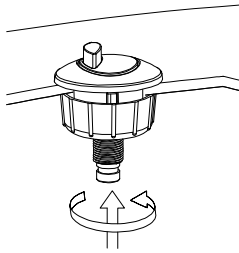

Insert the button into the hole on the water tank. Screw the nut.

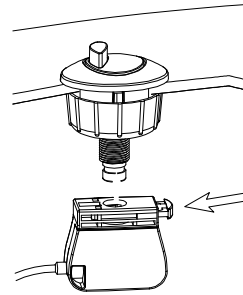

Push in the spring lock (a) which is on the control box and then insert button (b) into the control box.

7. Pipe installation

