

USER MANUAL

Product name – Concealed Cistern with Chrome Button

Product code – CISTERN003W



Single-person assembly

We always recommend using professional tradespeople to install your product

Important information

Please read these instructions thoroughly and retain for future reference
Please inspect the product fully for any damage or defects prior to installation
Please ensure pipework is cleaned out before installation
Installation must be carried out to these instructions
Do not use plumbers sealing putty or silicone sealants on any fittings
Ensure that frames, furniture and wall constructions can adequately carry the cistern when filled with 8kg of water
It is recommended to fit an in-line pressure reducing valve when pressure is over 8 bar static pressure
Do not use hot works close to cistern

Tools required

Drill
Screwdriver
Spanner
Water pump pliers
Spirit level
Protective cloth

Installation

CONCEALED CISTERN - FITTING GUIDE

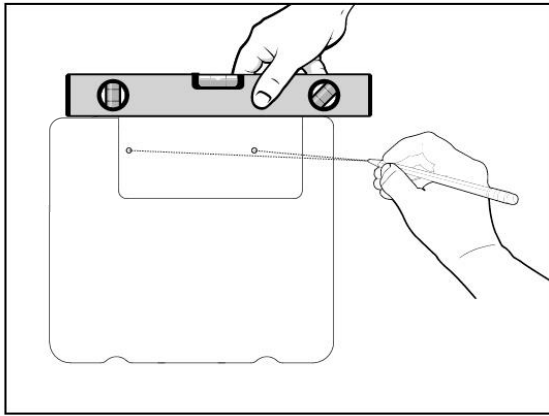

Position cistern where required.
Using holes in cistern, mark the position.

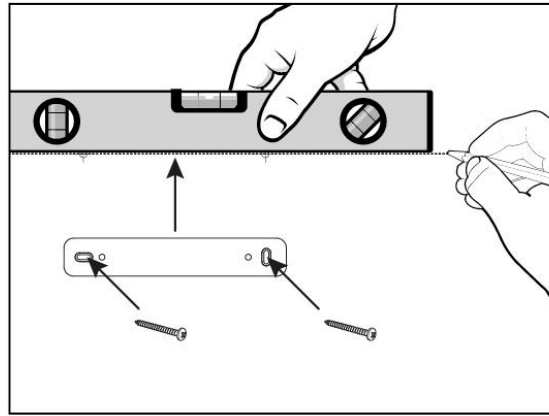

Use marks to draw a level line across the wall
or furniture. Use this to position the back plate.

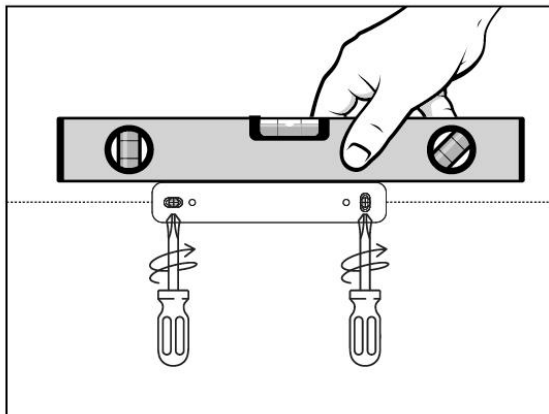

Fit plate using suitable screws. Ensure this is
installed level.

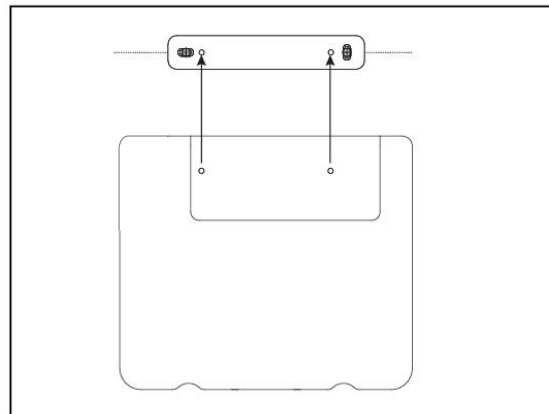

Place the cistern by directing the threads on
the plate through the holes on the cistern.

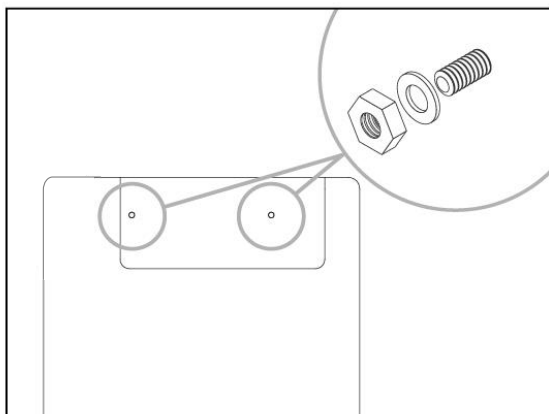

Secure the cistern by placing a washer and nut
onto the thread and tighten.

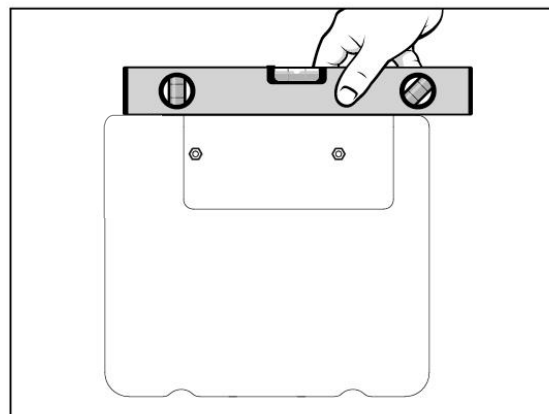

Now in place do one last check to see that it
is level.

Troubleshooting

Leaks

Check that all connections are fully tightened then re-check for leaks

Inlet Valve

Check that the float is free to move and that the valve shuts off when the float is raised. If not turn off water supply and disassemble the inlet valve. Carefully clean the diaphragm and filter assembly under running water. Reassemble and turn the water back on.

Water Level

Ensure that the actual water level aligns with the specified water level mark on cistern. If not adjust the flow restrictor

Overflow

Hold the inlet valve float down until the cistern begins to overflow. Ensure that the overflow pipe is capable of draining all incoming water. If not check that the flow restrictor has been fitted.

Outlet Valve

Check that the outlet valve flushes correctly. If not ensure all moving parts are free to move. Check that there is no water flow into the toilet pan when the outlet valve is shut. If there is, remove the flush valve from cistern and wash all sealing faces with clean water. Re-assemble valve and ensure it is working correctly.

Maintenance

We recommend that products like Bloo block should not be used, as this could damage or effect the function of the internal cistern mechanism.

We would also recommend to periodically check the product for leaks.

The cistern uses an internal overflow into the toilet pan this must be check periodically to avoid wastage of water.

Cleaning

This product should be cleaned using a soft cloth with warm PH neutral soapy water only.

The product must then be rinsed with clean water to dilute any soap. Polish and dry using a soft dry cloth after every use.