

# COB SHC3STP C

## COBALT Shower Range Cobalt Thermostatic Recessed Dual Control Shower Valve with Integral Twin Stopcocks



### Features:

- This shower valve has been designed to fit in any UK wall cavity and therefore only needs a 35mm deep cavity space
- Fitting depth including plasterboard and tiles is 60mm - 75mm
- Requires rear access to service the filters
- Cartridge can be accessed from the front
- Supplied with wall outlet

### Product Certifications:



WRAS Cert. Number: 2007908  
WRAS Expiry Date: 31/08/2025

For more products, visit our website:  
<http://www.bristan.com>



### Specification

Finish/Colour:	Chrome
Main Construction Material:	Brass
No of Controls:	3
Shower Type:	Recessed Dual Control
Shower Head Type:	None
Valve/Cartridge Type:	Thermostatic Cartridge & 3/4" Ceramic Disc Valve
Minimum Dynamic Pressure:	0.2 bar
Maximum Dynamic Pressure:	5.0 bar
Maximum Static Pressure: (bar)	10
Maximum Hot Water Supply Temperature °C:	65
Pre-set Outlet Temperature °C:	42
Plumbing System Suitability:	Suitable for all plumbing systems
Connection Inlet:	15mm Compression
Connection Outlet:	15mm Compression
Isolation Valve Included:	No
Check Valve Included:	Yes

### Dimensions (measurements in mm)

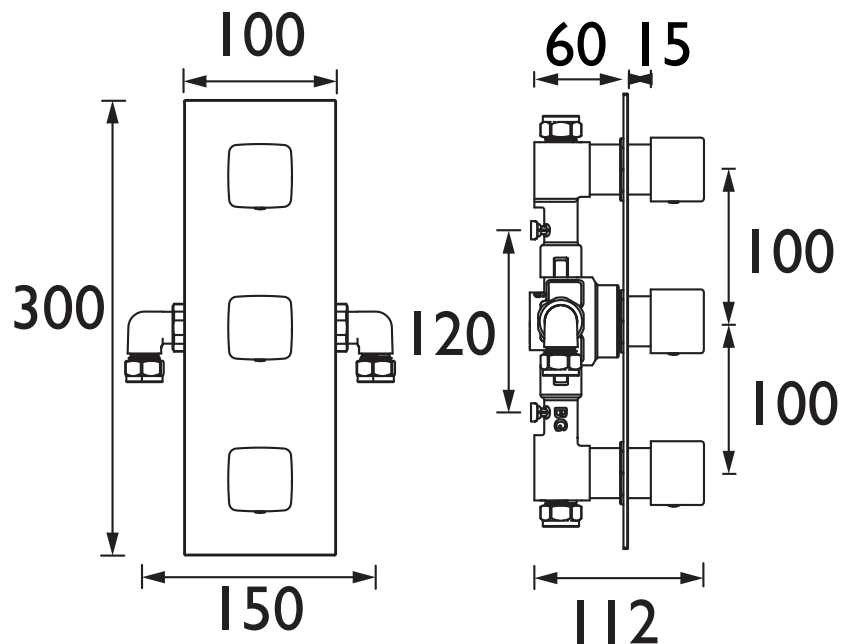

### Flow Rates (l/min)

System Pressure (bar)	0.2	0.5	1	2	3	5
Outlet 1	7.7	14.2	20.7	29.3	35.9	46.3
Outlet 2	7.3	14	20.8	29.4	36	46.5

TECHNICAL  
DATA  
SHEET



**BRISTAN**

D7