

S8 Wetroom Screen

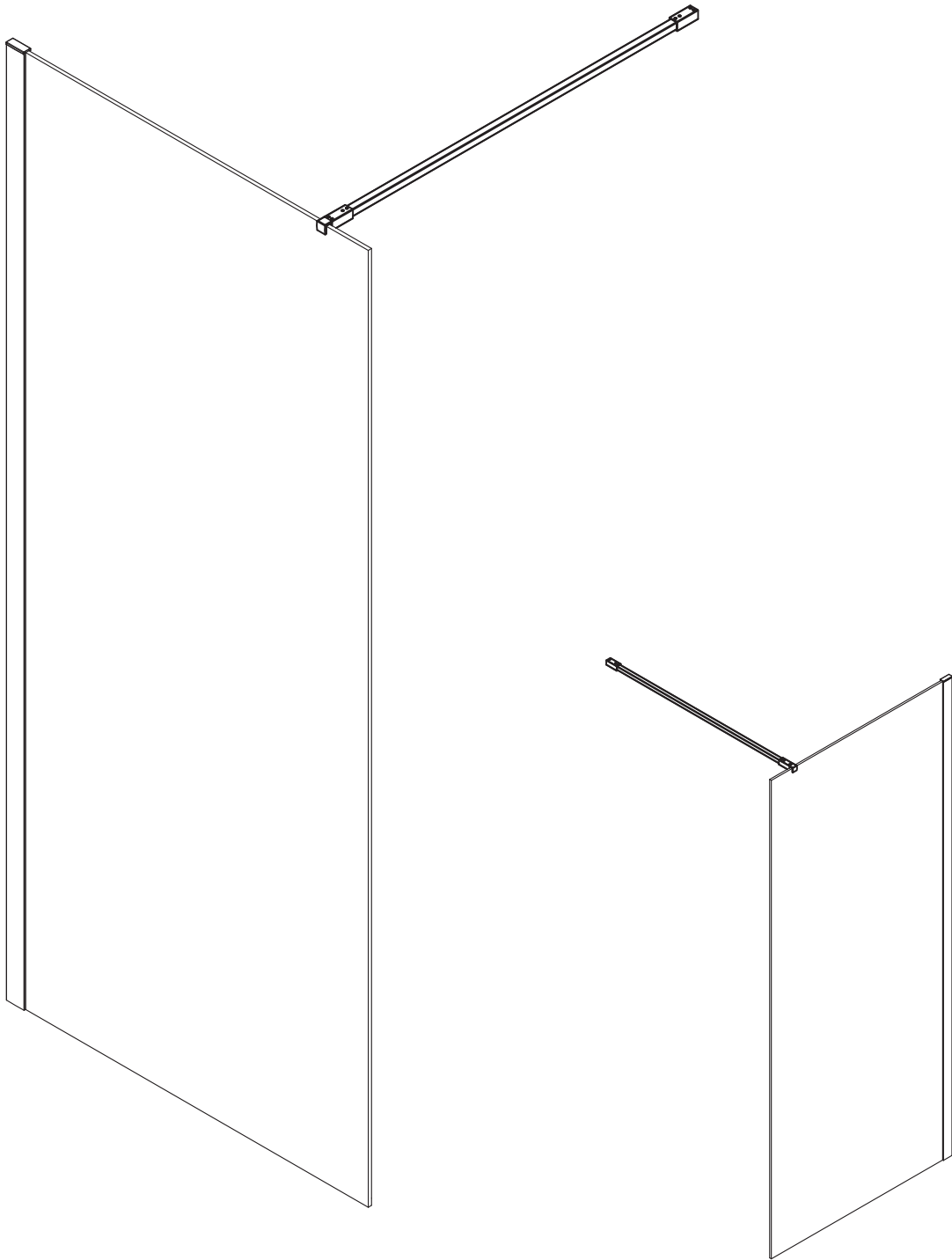

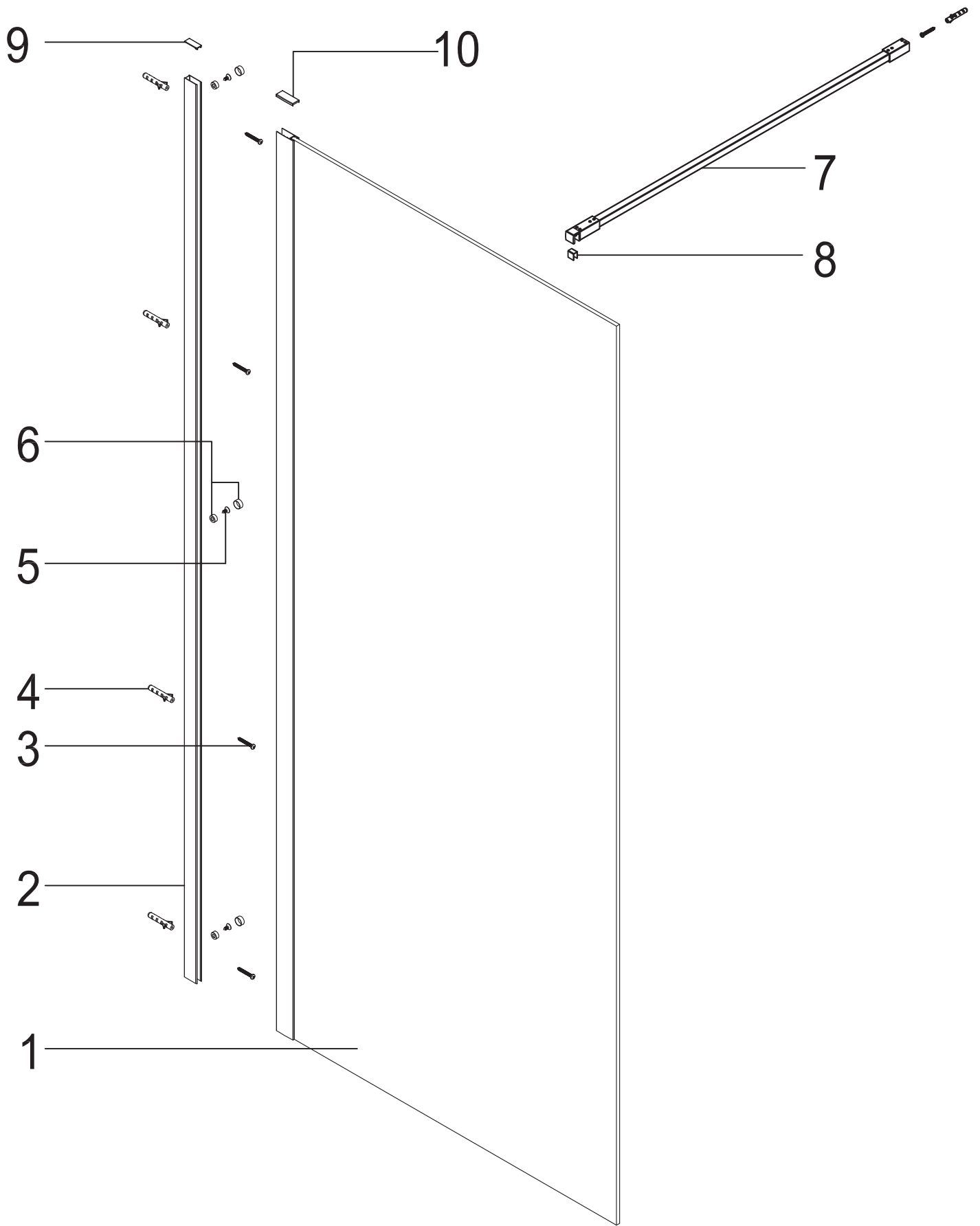

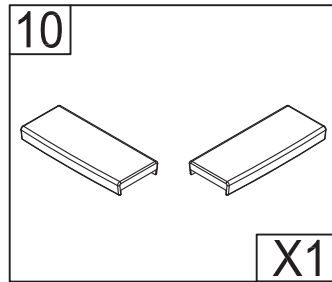

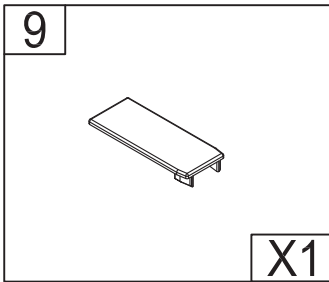
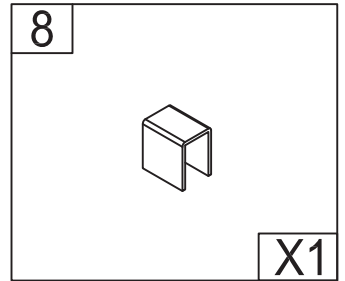
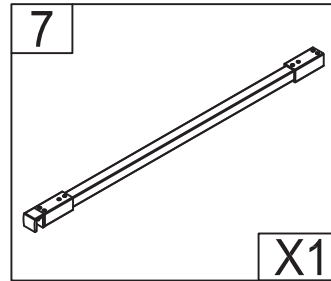
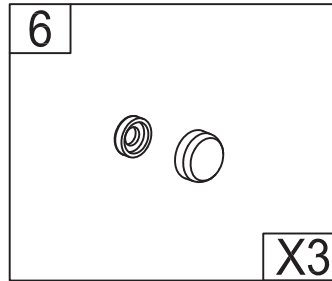
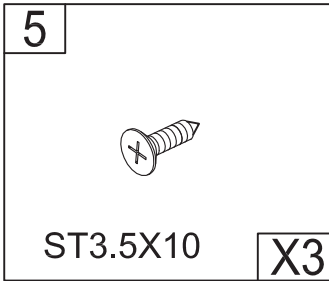
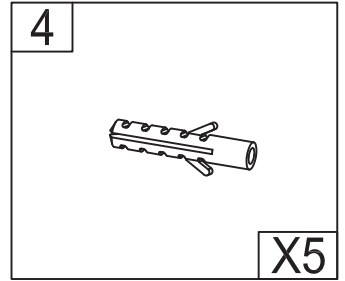
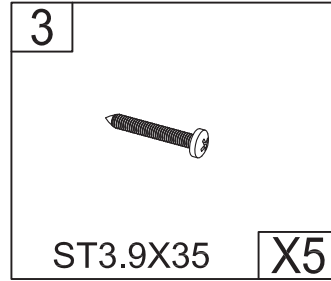
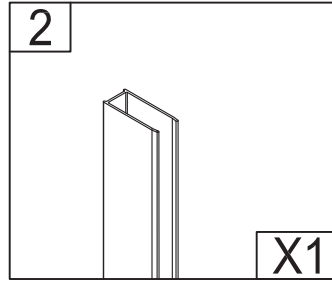
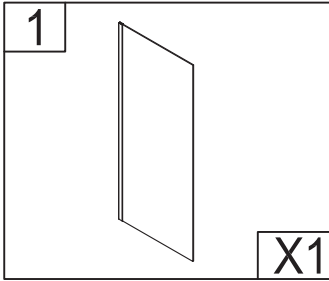
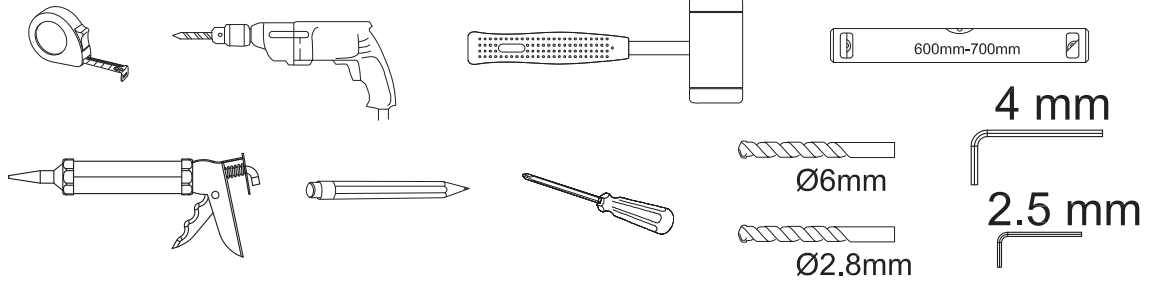
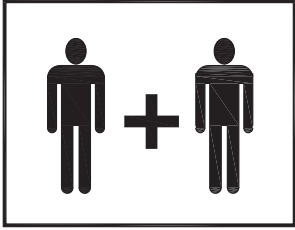
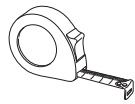
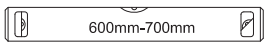

Ø6mm

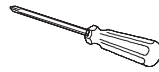
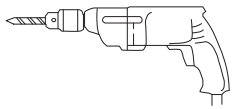
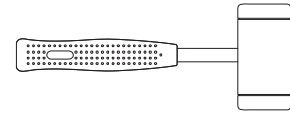

Ø2.8mm

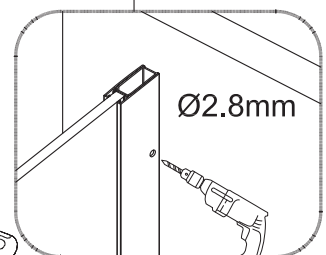
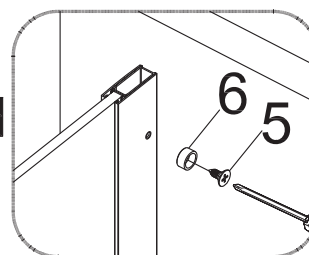
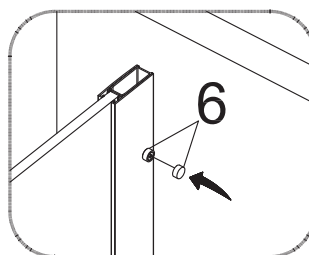
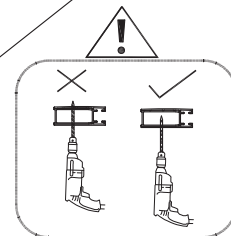
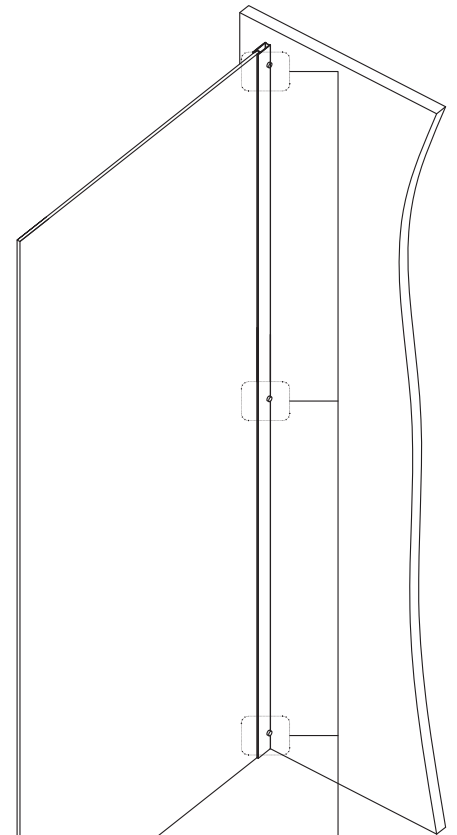
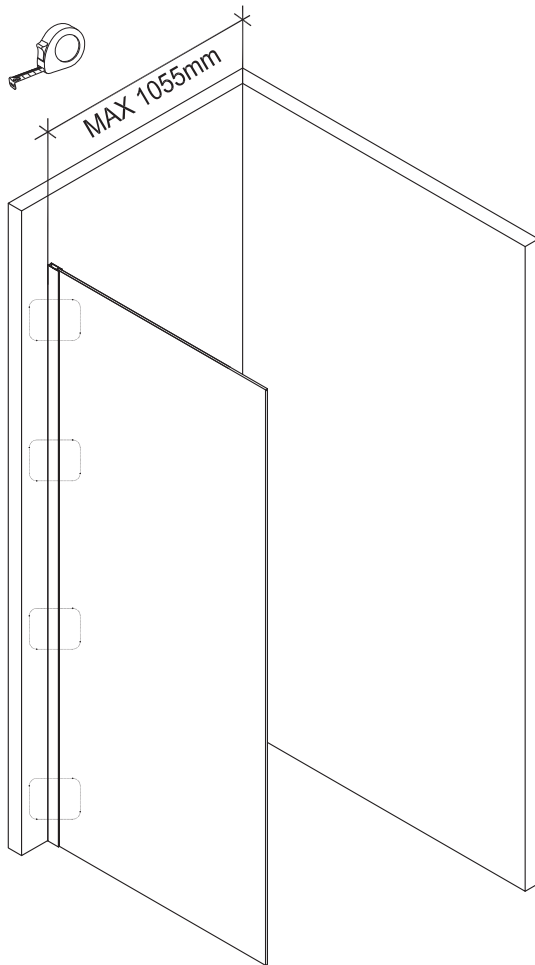
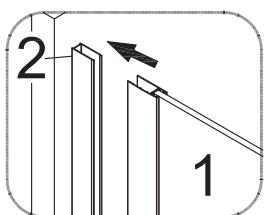
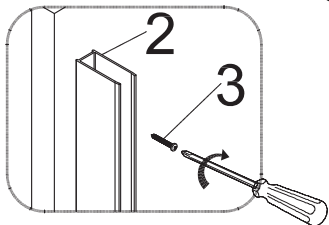
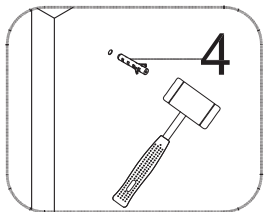
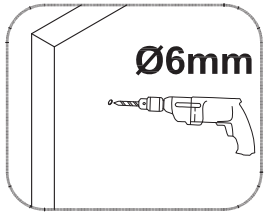
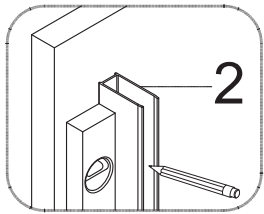
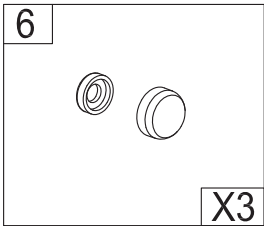
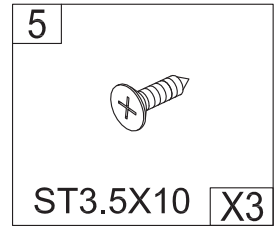
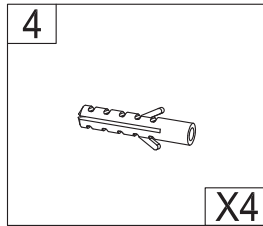
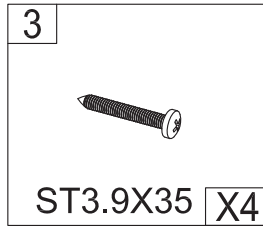
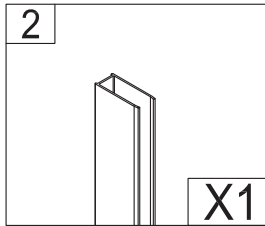
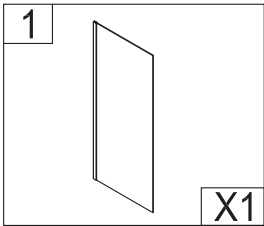

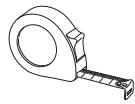
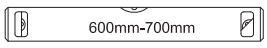

Ø6mm

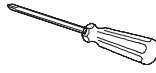
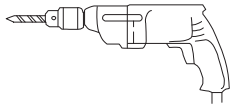
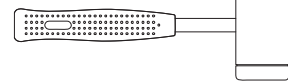

4 mm



2.5 mm

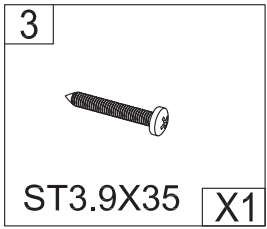

ST3.9X35

X1

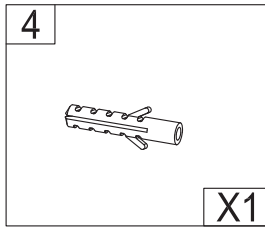

X1

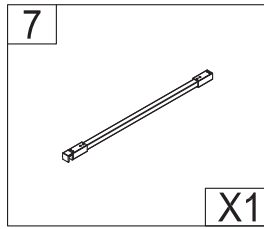

X1

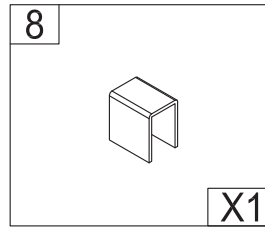

X1

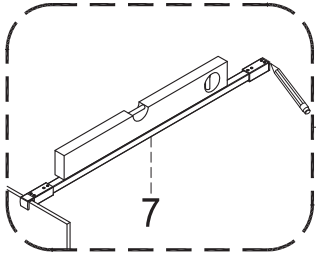

7

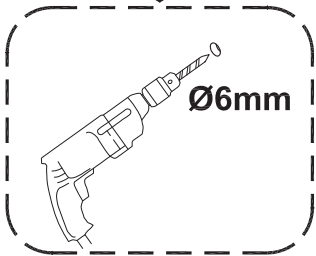
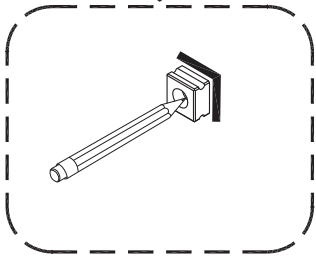

Ø6mm

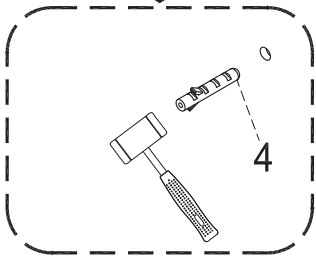

4

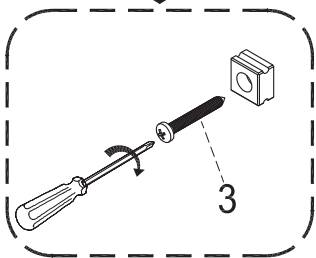

3

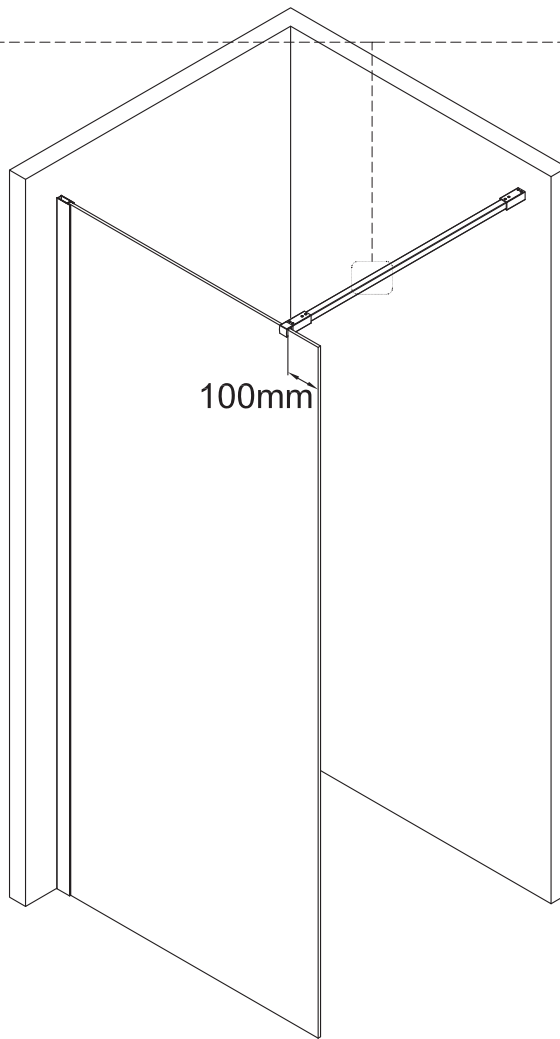

100mm

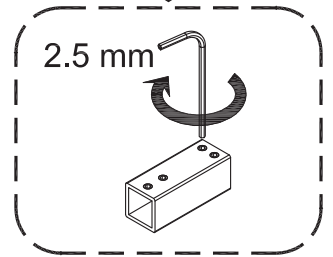
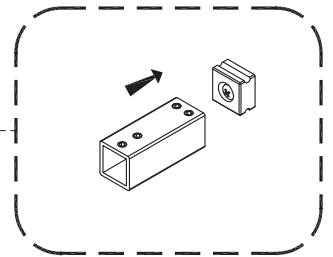

2.5 mm

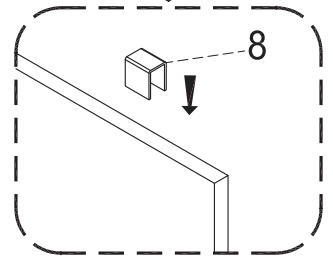

8

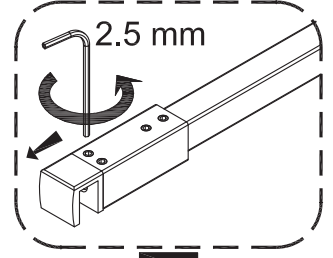

2.5 mm

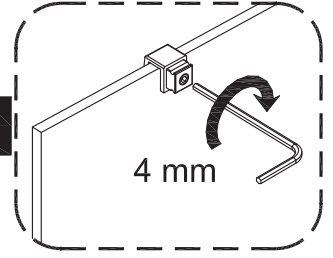
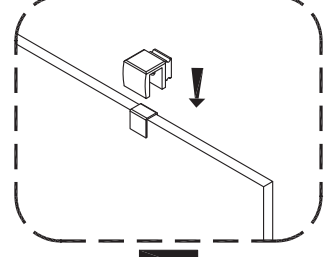

4 mm

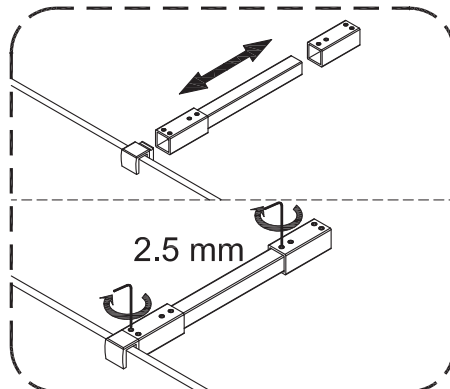

2.5 mm

5

S8 Wetroom Screen

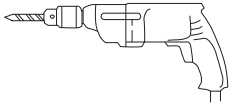

Ø6mm

