

Installation Instructions

DucoStone and DucoLite Shower Trays



Before you Start



Please read these instructions fully before starting. Although these instructions are comprehensive we always recommend that a technically competent installer undertake the installation.

Unpack and check that the shower tray is the colour, size, shape and type you require. Allow the shower tray to rest on a flat surface in a warm room then check for any damage. **Do not install if not satisfied and contact your local supplier.**

Check that the top surface of the shower tray is compatible with your intended shower enclosure, taking into account the loss of dimension that will result if the tray has been cut or trimmed to fit the available area and after tiles etc have been fitted.

The compatibility of the top surface of the tray and an enclosure is especially important if using a shower tray with a built in tiling upstand.

If you install this shower tray in conjunction with a steam unit, you must ensure the steam outlet is at a minimum of 350mm from the top of the tray.

When considering your installation method, you should be able to attach or repair your waste or waste outlet in-situ.



Important

When handling your shower tray take care not to damage the bottom edges and when installing take particular care to protect the visible surfaces from impact damage or abrasions.



Safety Notes

Caution: Care must be taken when drilling into walls or floors to avoid hidden pipes or electrical cables.

This product is heavy and requires a 2-person lift.



Care & Use of Your Shower Tray

These installation instructions should be retained and passed to the user for possible future reference.

It is normal for small amounts of localized water to be retained on the shower tray surfaces after use which should be wiped dry immediately to prevent build up of sediments.

The shower tray should be cleaned regularly with warm, soapy water only and dried with a cloth. Never use scourers, abrasives, bleach or other chemical cleaners.



Technical Help

Technical Service Line: 0845 505 2211/ 01684 293311 Open Mon–Fri 9am–5pm



Dimensions are nominal and shown in millimetres unless otherwise stated.

Parts Supplied

- A** Shower Tray (Shape and style of tray may differ from that illustrated)

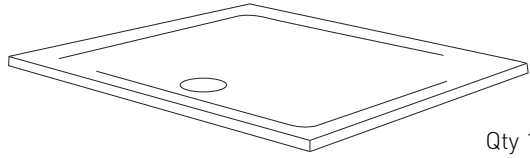

Qty 1

Tools and Materials Required (not supplied)

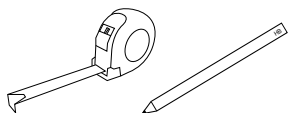

Tape Measure and Pencil



Spirit Level

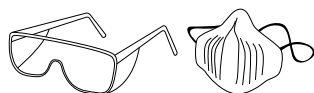

Safety Eyewear and Dust Mask

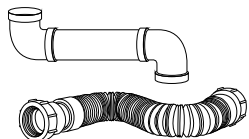

Plumbing Pipe and Fittings



90mm Hi-flow Waste Unit



Compound or Contact Adhesive

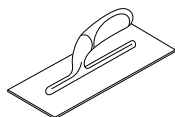

Trowel

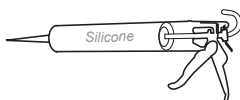

Silicone Sealant

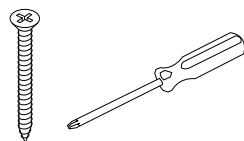

Floor Screws and Screwdriver

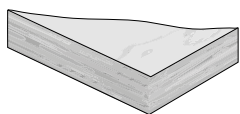

Plywood Board (min 18mm thick)

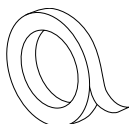

Masking Tape



Cement and Fine Sand

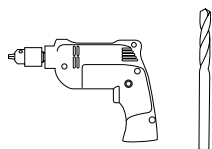

Power Drill & Drill Bits

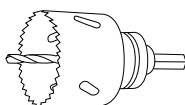

Hole Cutter

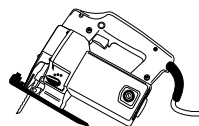

Jigsaw



60 Grit Sand Paper



Angle Grinder

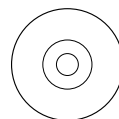

4in/102mm or larger fine edge diamond grinder blade (suitable for cutting stone)

Note! Other tools and materials may be needed depending on the specific site requirements.

Cutting the Tray

Your unique Duco shower tray is the idea solution to modern bathroom shapes and obstacles enabling rapid adaptation to almost all situations.

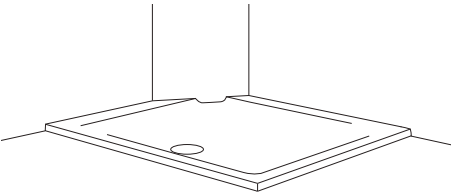
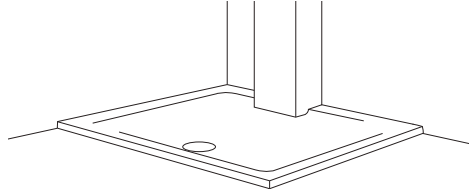
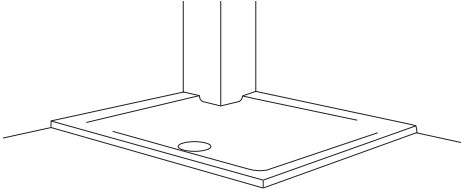

Note! Your shower tray can also be used, after cutting, with a Panel Riser Kit for a raised installation. Please note that a Baseboard Accessory Pack **MUST** be used in conjunction with your chosen Panel Riser Kit.

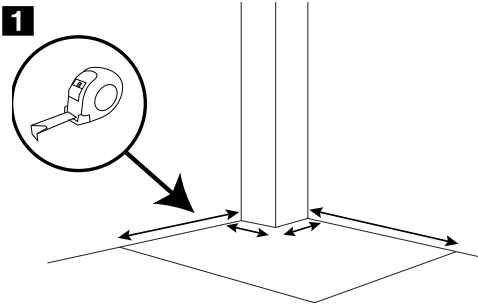

Carefully measure the available area for your intended shower tray.

Note! Ensure the outer tray dimensions remain suitable for your intended enclosure taking into account the reduced area that will result after any trimming or cutting of the shower tray.

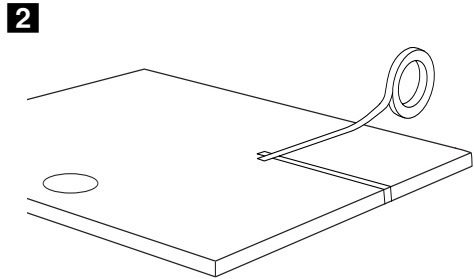

With the shower tray upside down, mark the lines to be cut on the back of the tray using masking tape or other suitable marking method.

Note! Double check the area marked on the back face of the shower tray is correct when the tray is upright in-situ. DO NOT PROCEED IF NOT SATISFIED.

CAUTION! Before proceeding use safety eyewear and clothing at all times.

Cutting the Tray

3

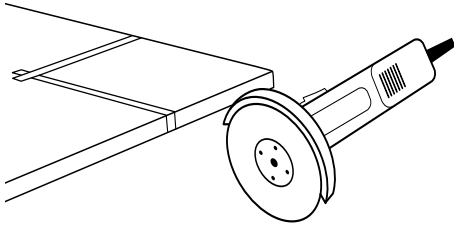

Carefully cut the marked area from the shower tray using a minimum of a four inch (approx 102mm) diamond blade (suitable for cutting stone) on an angle grinder or other suitable cutting tool.

4

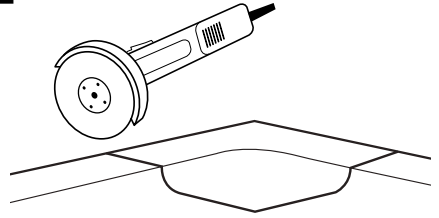

It may be necessary to turn the shower tray over to obtain a through cut on the thicker section of the periphery of the tray, depending on the size of the blade being used.

Note! Do not force the rate of cutting and only cut at the speed of the cutter to avoid separation of the tray layers.

5

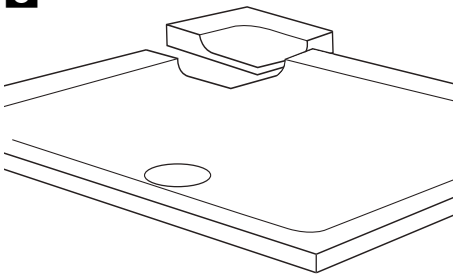

Taking care not to damage the visible surface, carefully remove any loose material and tidy the cut edge using 60 Grit (or similar grade) sand paper.

6

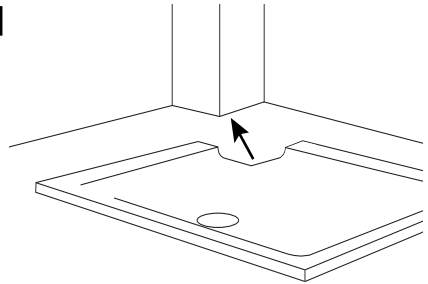

Test fit the shower tray in-situ making any further adjustments as necessary to ensure a snug fit.

Note! It is normal for the tray to appear elastic when undertaking a dry test fitting.

Once you are satisfied, complete the installation by following the procedure for solid or suspended floors as appropriate.

DO NOT PROCEED IF NOT SATISFIED.

Note! If using a Panel Riser Kit and Baseboard Accessory pack is used for a raised installation, refer to both instructions supplied with the kits.

Installation – Solid Floor

1

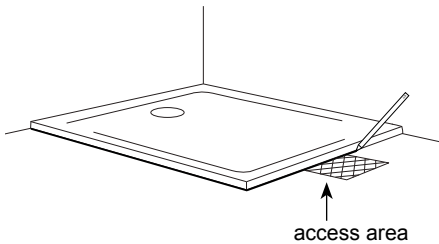

Place the shower tray **A** in position on the floor (ensuring surface is level) and mark the perimeter and waste hole on the floor including an area outside the perimeter for access to connect plumbing (as dictated by the installation location) after the shower tray has been installed. If using a shower tray with a built in tiling upstand, allowance must be made for recessing the tray into adjacent walls to allow tiling down onto the tray surface.

2

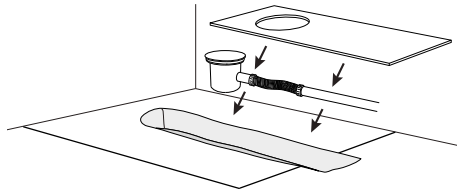

Form a trench in the floor to hold the waste unit and piping.

Before proceeding, dry fit all items in-situ to ensure compatibility.

Install the waste unit and piping in the trench in accordance with building regulations, protecting any exposed threads with masking tape.

If necessary, blank off the trench using 18mm ply with waste outlet hole, ensuring that the plumbing connections can be made once the shower tray is in position.

3

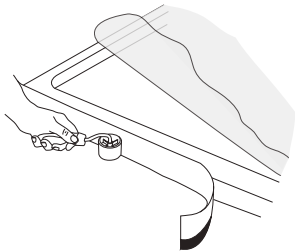

Note! Some shower trays have a protective film (indicated by a label on the surface) which must now be removed. Undertake a final inspection of the shower tray at this stage. DO NOT PROCEED IF NOT SATISFIED.

We recommend the use of the optional Flexi Seal Strip (not supplied). If fitting, follow the instructions later in this guide to attach the strip to the shower tray at this stage.

4

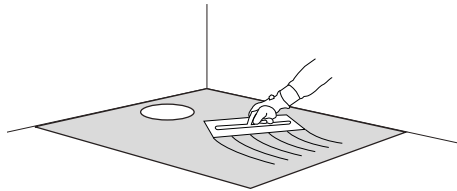

Use installation compound adhesive or a suitable contact adhesive to cover the full area under the shower tray. Apply or trowel to a thickness suitable to allow full adhesive support of the shower tray.

Note! Always follow the instructions supplied with the adhesive.

Installation – Solid Floor

5

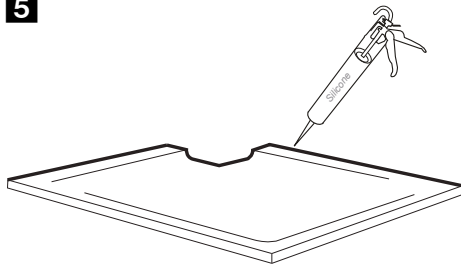

Before fitting, apply copious amounts of silicone to the edges of the shower tray **A** against all wall contact points.

This is especially important on any edges of the tray that have been cut or trimmed.

6

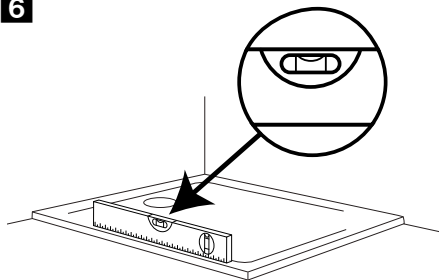

Place the shower tray **A** onto the wet adhesive ensuring that it is fully supported by the mix. Check the level of the top rims only as the shower tray has a built in fall for adequate drainage.

Note! Ensure tray is fully stuck down – weight down if necessary to ensure level and that good contact is made with the adhesive.

7

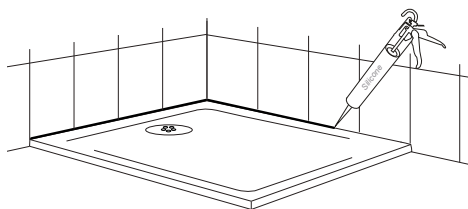

When the adhesive has set, remove any excess mix and masking tape, then make connection between the shower tray and waste piping. The shower tray and all connections **MUST** now be checked for water tightness, flow and adequate drainage over the entire area.

DO NOT PROCEED IF NOT SATISFIED.

After all checks and adjustments, tile and then seal along the tiling line with silicone sealant.

8

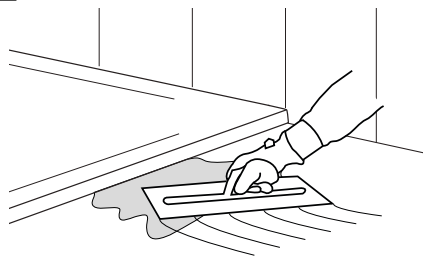

Fill in the access area in front of the shower tray **A** with cement.

If fitting a shower enclosure refer to the manufacturers installation instructions.

Installation – *Suspended Floor*

1

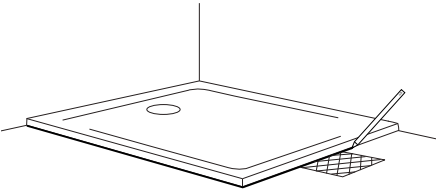

Place the shower tray **A** in position on the floor (ensuring surface is level) and mark the perimeter on the floor including an area outside the perimeter for access to connect plumbing (as dictated by the installation location) after the shower tray has been installed.

If using a shower tray with a built in tiling upstand allowance must be made for recessing the tray into adjacent walls to allow tiling down onto the tray surface

2

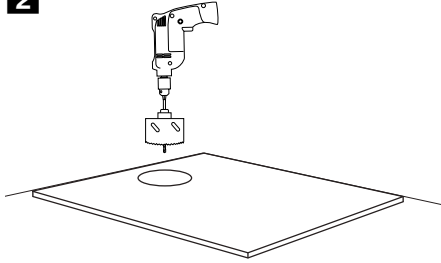

The floor area (or larger) covered by the shower tray must be removed and replaced with a single level piece of plywood (minimum 18mm thick).

Put the plywood in position, ensuring the area is flat and level. Place the shower tray **A** on the plywood and mark the waste hole location.

Remove the shower tray then use a hole cutter to drill a hole in the plywood large enough to pass through the entire waste unit. Keep all holes to the minimum.

3

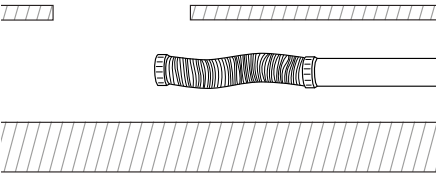

Remove the plywood and install the waste outlet pipe in the cavity in accordance with building regulations.

4

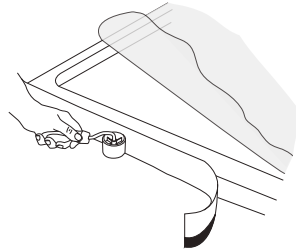

Note! Some shower trays have a protective film (indicated by a label on the surface) which must now be removed. Undertake a final inspection of the shower tray at this stage. DO NOT PROCEED IF NOT SATISFIED.

We recommend the use of the optional Flexi Seal Strip (not supplied). If fitting, follow the instructions later in this guide to attach the strip to the shower tray at this stage.

Floor Level Installation for Suspended Floors

Installation – *Suspended Floor*

5

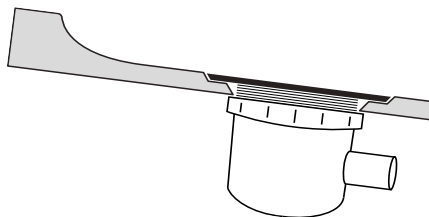

Fit the waste unit to the shower tray following the instructions supplied with the unit and protect exposed threads with masking tape. Before proceeding dry fit all items in-situ to ensure compatibility and then screw the plywood level into position.

Note! It is normal for the tray to appear elastic when undertaking a test dry fitting.

6

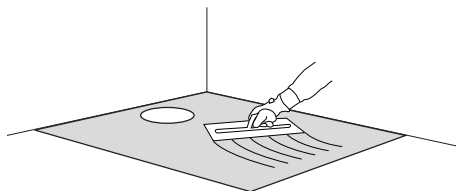

Use installation compound adhesive or a suitable contact adhesive to cover the full area under the shower tray. Apply or trowel to a thickness suitable to allow full adhesive support of the shower tray.

Note! Always follow the instructions supplied with the adhesive.

7

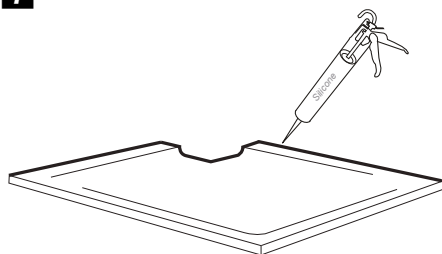

Before fitting, apply copious amounts of silicone to the edges of the shower tray **A** against all wall contact points.

This is especially important on any edges of the tray that have been cut or trimmed.

8

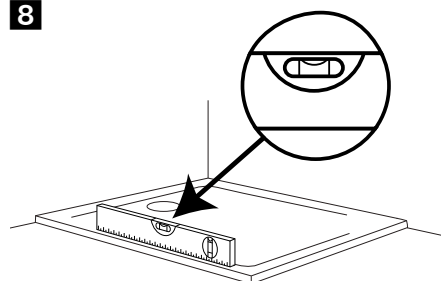

Place the shower tray **A** onto the wet adhesive ensuring that it is fully supported by the mix. Check the level of the top rims only as the shower tray has a built in fall for adequate drainage.

Note! Ensure tray is fully stuck down – weight down if necessary to ensure level and that good contact is made with the adhesive.

Installation – *Suspended Floor*

9

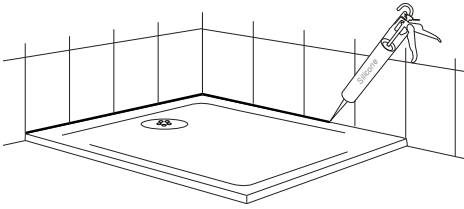

When the adhesive has set, remove any excess mix and masking tape then make connection between the shower tray and waste pipe. The shower tray and all connections **MUST** now be checked for water tightness, flow and adequate drainage over the entire area.

DO NOT PROCEED IF NOT SATISFIED.

After all checks and adjustments, tile and then seal along the tiling line with silicone sealant.

If fitting a shower enclosure refer to the manufacturers installation instructions.



Troubleshooting

Q Can I cut large areas of the tray?

A Yes, providing that the outer dimension of the enclosure is maintained and that the waste outlet area is not affected.

Q What is a suitable contact adhesive?

A Contact your local DIY retailer and request an adhesive intended for sticking ABS (the plastic base of the shower tray) to wood/concrete as applicable.

Q Can I use a Panel Riser Kit with this type of shower tray?

A Yes a Panel Riser Kit suitable for the size and shape of tray can be used on this type of shower tray. However, if the tray has been cut or is over 1000mm on any one dimension a Baseboard Accessory Kit **MUST** be used in conjunction with your chosen Panel Riser Kit.

Q The waste outlet in the shower tray is directly over an obstruction at floor level.

A Consider switching to a Panel Riser Kit or re-locating the shower tray.

Q There is water retaining on the surfaces of the tray.

A Check that the shower tray is level (top rims) as it is normal for small amounts of localized water to be retained.

Q Water will not flow fast enough down the waste outlet.

A Check that the waste unit is correctly installed and that outlet pipe has sufficient angle and is not kinked or sagging causing an air blockage.

Q The enclosure will not fit on the shower tray.

A Check that you have maintained the outer dimensions of the tray after any cutting adjustments and that the available surface on top of the tray is compatible with the size, shape and adjustment range of your enclosure.

Q Water escapes from a fitted walk-in or frameless enclosure.

A It is normal for spillage to occur from walk-in or frameless type enclosures, consider fitting a threshold seal or changing to a fully framed enclosure.

Flexi Seal Strip

(not supplied with shower tray)

This product is intended as a flexible tiling upstand and should be fitted to the side of the tray adjacent the walls only.

Tools and Materials Required (not supplied)



Scissors

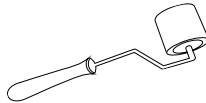

Small Roller

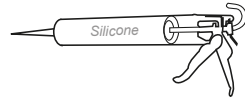

Silicone Sealant

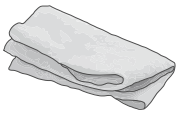

Damp Cloth

Installation – Flexi Seal Strip

This product is intended as a flexible tiling upstand and should be fitted to the side of the tray adjacent the walls only.

1

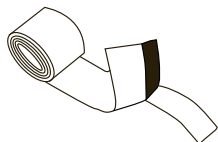

Wipe the surfaces clean where the strip will be attached first with a clean damp cloth, allow to dry and then wipe with the IPA wipe supplied in the kit.

Determine the length of strip required to seal around the shower tray and cut to length with scissors. (Ensure you cut at least 20mm longer than needed).

Peel back approximately 20cm of backing from the adhesive strip.

2

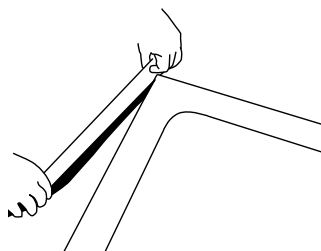

Attach to the edge of the shower tray so that it is square and the edge protrudes at least 20mm above the edge of the tray.

Make sure the adhesive strip is positioned so that it will not come into contact with any silicone sealer used later.

Note! If applying to a cut or trimmed tray, ensure that the adhesive edge follows the top edge of the tray and any material below the base of the tray should be removed with a sharp knife.

3

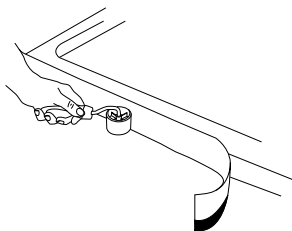

Using a small roller or other appropriate tool roll the seal strip so that it attaches firmly to the edge of the tray removing any bubbles or creases, paying particular attention to the corners.

Gradually remove the cover strip in sections and roll on the seal so it attaches firmly and square to the edge of the tray, making sure there are no gaps between tray and seal strip. Trim off any excess strip.

4

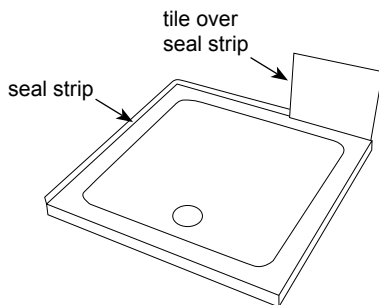

Install the shower tray in the correct position and tile in front of the seal strip.

Put a protective bead of silicone or other suitable flexible sealant between the tray and the tile, ensuring it does not come into contact with the adhesive material on the flexi seal strip.

Product supplied by the MX Group and/or its subsidiaries

Technical Service Line: **0845 505 2211 / 01684 293311** Open Mon–Fri 9am–5pm