

**Inline 2 Sided Enclosure**

**INSTALLATION INSTRUCTIONS**

[www.aquadart.co.uk](http://www.aquadart.co.uk)

Please read through the complete instruction leaflet before commencing any installation work!

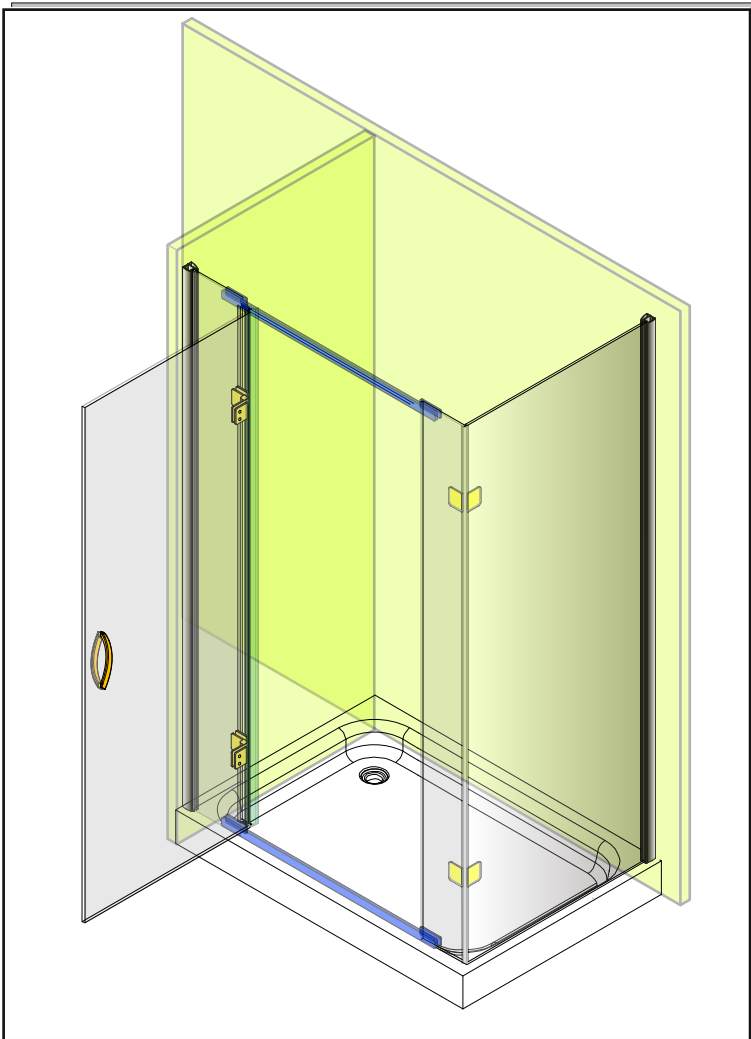

**Tools Required**

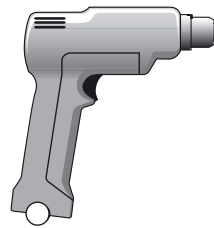

Drill



6mm Masonry Drill  
2.75mm HSS Drill

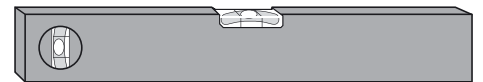

Spirit level

Tape Measure

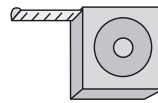

Pencil

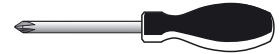

Screwdriver

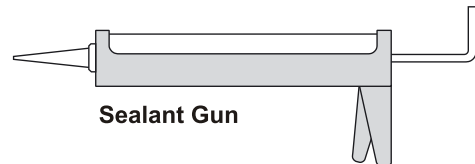

Sealant Gun

Please note hand tools **NOT** supplied.

**IMPORTANT**

This product should be installed by a suitably qualified and proficient person. The fitting instructions should be followed carefully to ensure a proper and safe installation. Failure to follow these instructions could result in future injury.

These instructions and list of parts assume that installation is done against solid/tiled walls.

Please check this product for damage prior to starting the installation. No claims can be made after the product has been fitted.

PLEASE NOTE :The minimum and maximum adjustment sizes noted on the product brochures are based on perfectly plumb walls and trays.

**USE SAFETY EYE-WEAR WHEN DRILLING**

# Installation showing the Inline 2 Sided Enclosure.

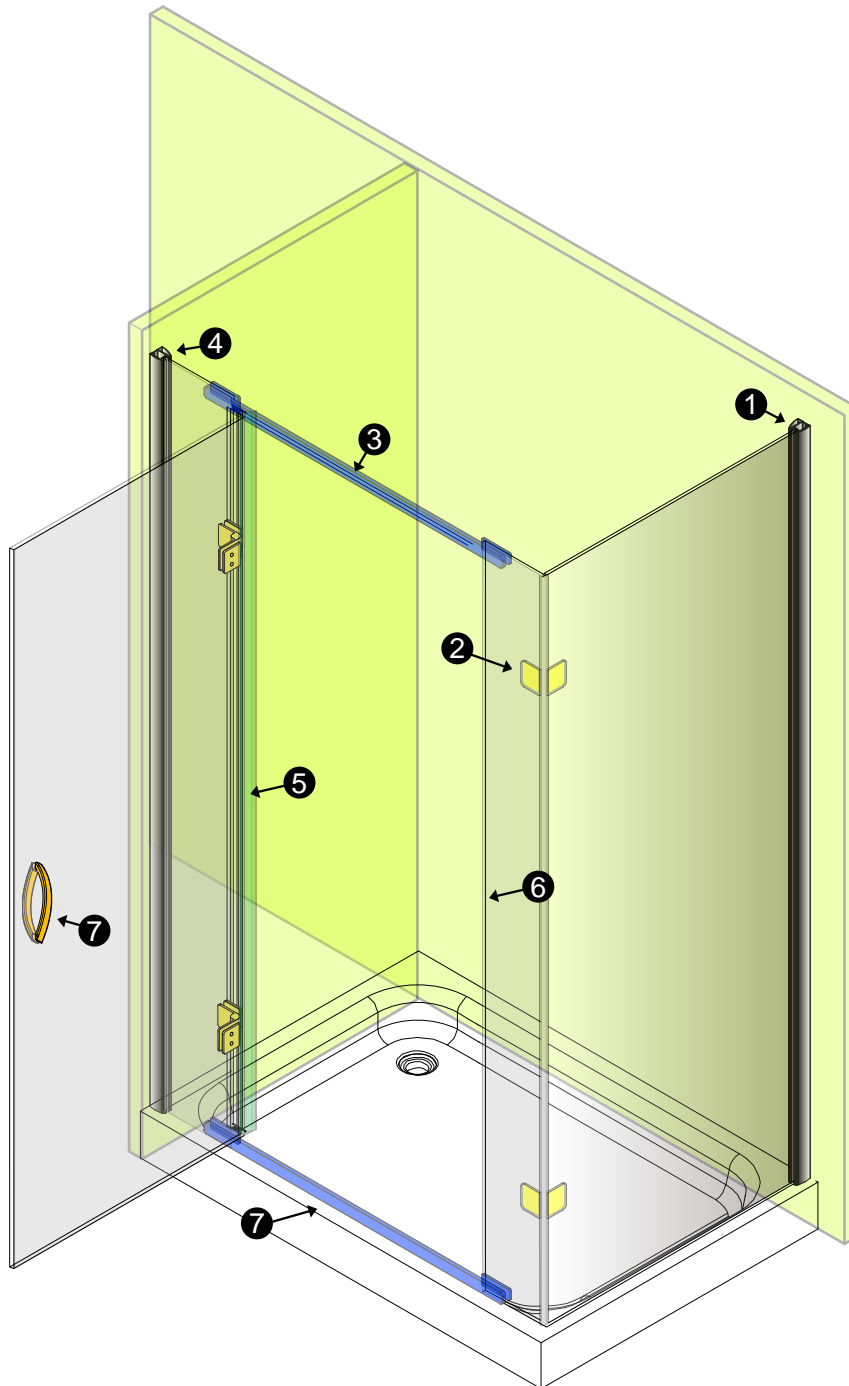

Please refer to the written instructions on the next page

# Inline 2 Sided Enclosure.

## Inline 2 sided enclosure

1/ Firstly attach one of the wall profiles to the side panel and attach to the wall, see "fixing the wall profile" information page for more details.

2/ Attach the small infill panel to the side panel using the corner profile seal and the corner brackets. See "fixing the corner brackets" information page for more details.

3/ now fix the infill panel to the hinged infill panel using the bracing bars, see "fixing bracing bars" information sheet for more information.

4/ Repeat step 1 with hinged infill panel, see "fixing wall profile" information sheet.

5/ Press the hinge deflector seal onto the door panel on the hinged side, ensure the deflector strip is located on the inside of the enclosure, see "fixing the seals and handle sheet for more information".

6/ press the magnet seal onto the side of the large side panel, see "fixing the seals and handle sheet for more information".

7/ install the handle onto the glass door first. Then press on the magnet seal and the bottom water deflector, see "fixing the seals and handle sheet for more information".

8/ Hang the door onto the frame as shown in "hanging the door " information page.

9/ make all necessary adjustments to the door and frame to ensure the door operates properly.

Please note the magnetic seals can be pulled away from the glass to allow for small adjustments. There is also a large amount of horizontal adjustment in the bracing bars, the frame can be widened or made smaller.

10/ ensure all fixings are now tightened and the wall profiles and side panels are fixed.

11/ the enclosure will now need to be silicone sealed, seal the inside where the enclosure meets the tray and wall. Leave the silicone to set for 24 hours before using.

# Fixing the wall profile

Using a pencil mark out the position of the wall channel on the wall. Make sure the wall channel is plumb by using a spirit level as shown. Carefully drill the holes for the fixings using a 6mm masonry drill bit.

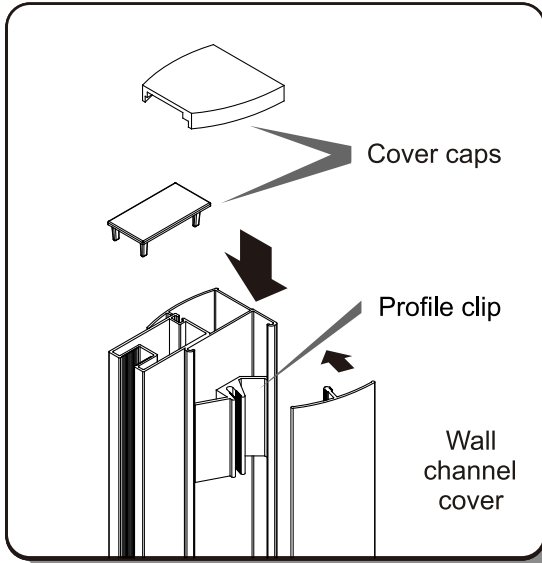

Lastly clip the cover caps and wall channel cover profile to the wall channel as shown left. Slide 5 x Profile Clips in to the wall channel and evenly space. then push the Cover Profile into the Profile Clips.

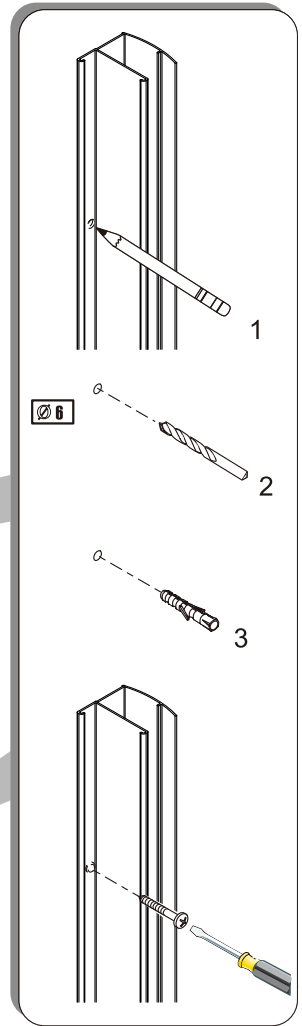

Using a screwdriver fix the wall channel to the wall taking care not to over tighten the fixings.

## PLEASE NOTE

Do not fix into position until the door frame has been adjusted and you are happy with the installation

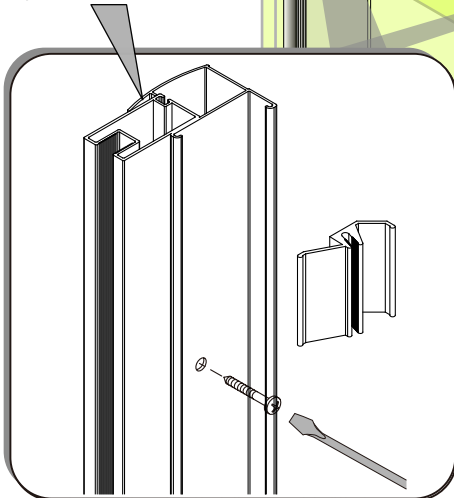

Gently offer the vertical frame section into the wall channel and fix to the required position. This is done by drilling through the wall channel using a 2.75mm HSS drill bit. Using a screwdriver and the fixings provided fix the vertical frame section to the wall channel as shown above.

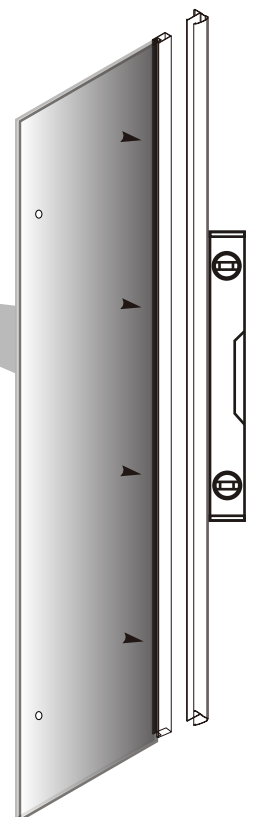

# Fixing the corner brackets

You can choose which seal to use. One is for a more frameless look (A). The other is used when using body jets and strong water pressure (B).

Corner profile seal

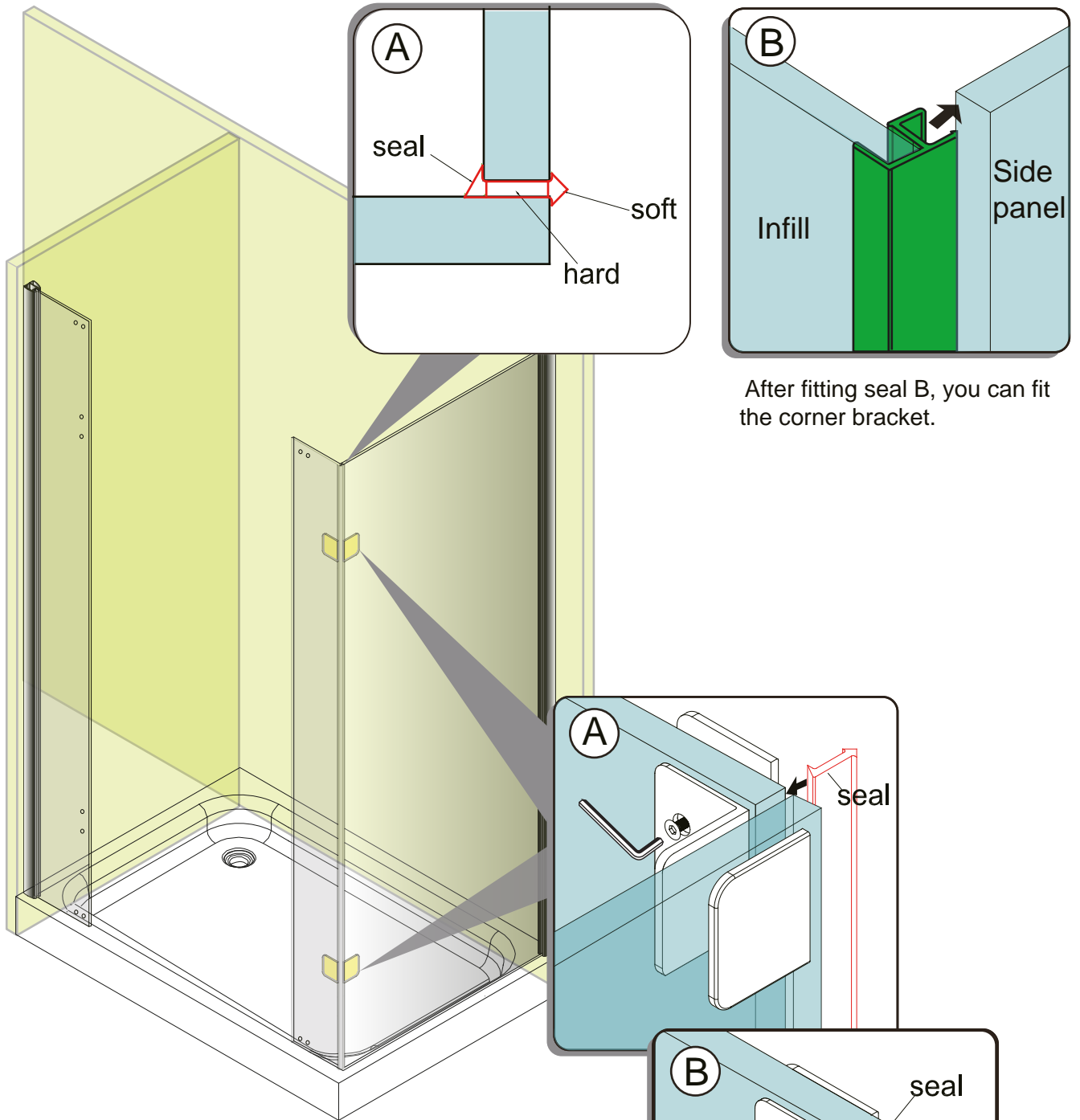

After fitting seal B, you can fit the corner bracket.

To fit seal A. Assemble the bracket loosely then insert the gasket between the two glasses, and then tighten with screw.

## Fixing the bracing bars.

Do not tighten the bracing bars until the installation is finished as this will allow for any adjustments that need to be made

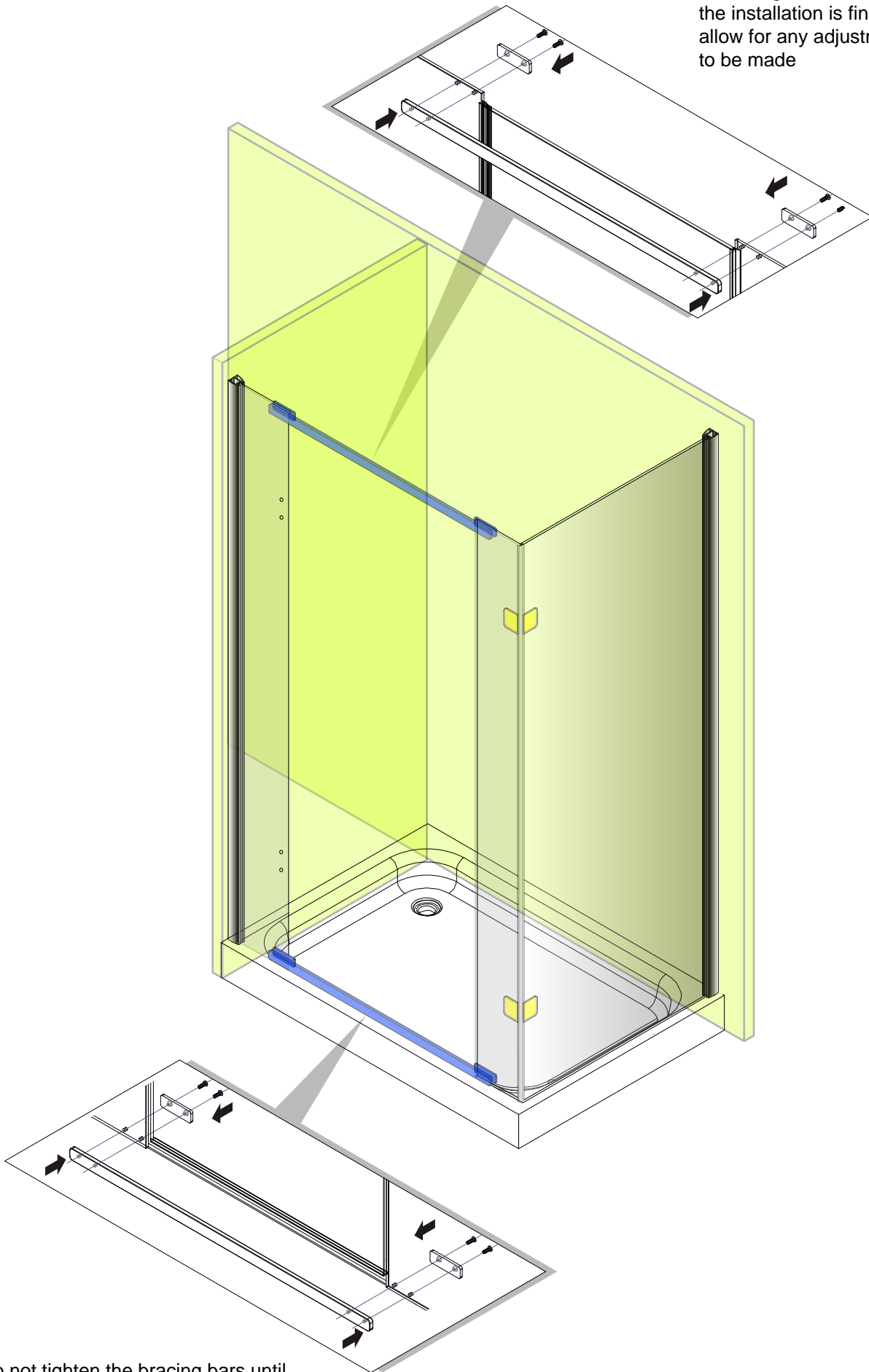

Do not tighten the bracing bars until the installation is finished as this will allow for any adjustments that need to be made

# Hanging the door.

When hanging the door we recommend that 2 persons carry out this operation.

To hang the door, the door must be positioned 90° to the enclosure as shown above.

Carefully lift the door so that the hinges on the door line up exactly with the hinge plates fitted to the enclosure.

Gently lower the door into position so that both hinges are fully joined together.

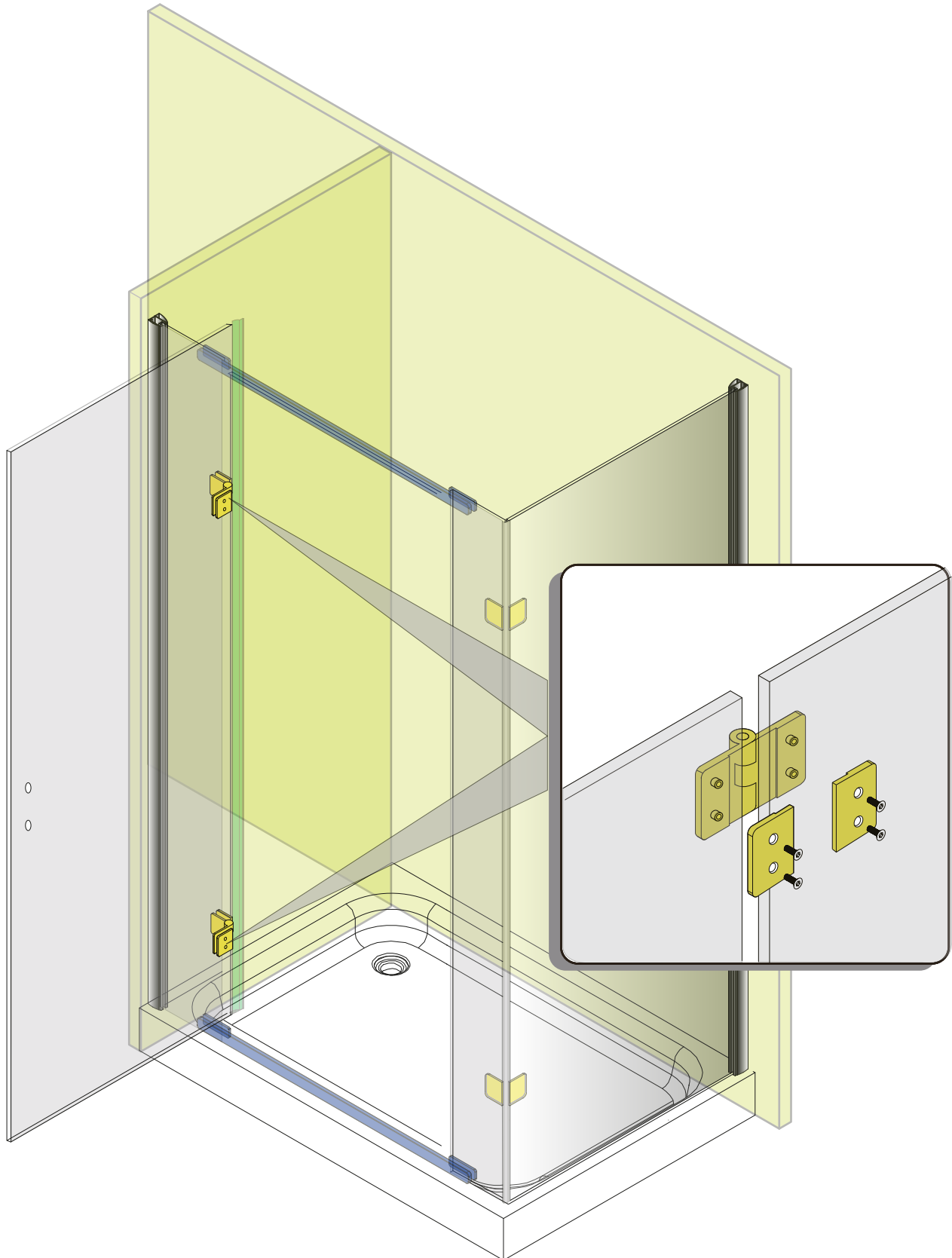

Ensure that the door operates correctly by making adjustments to the door and frame.

# Fixing the hinge deflector seal, Magnetic door seals & handle.



When fitting the magnetic door seals to the in-fill panel and door panel ensure that the magnetic seals are in the correct position as shown above thus ensuring a correct seal when the door is closed.

Carefully attach the handles to the door panel as shown below by using a cross headed screwdriver. DO NOT over tighten the fixings.

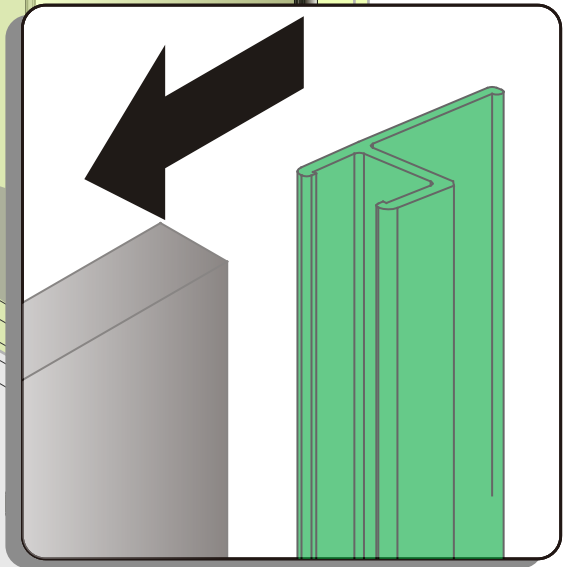
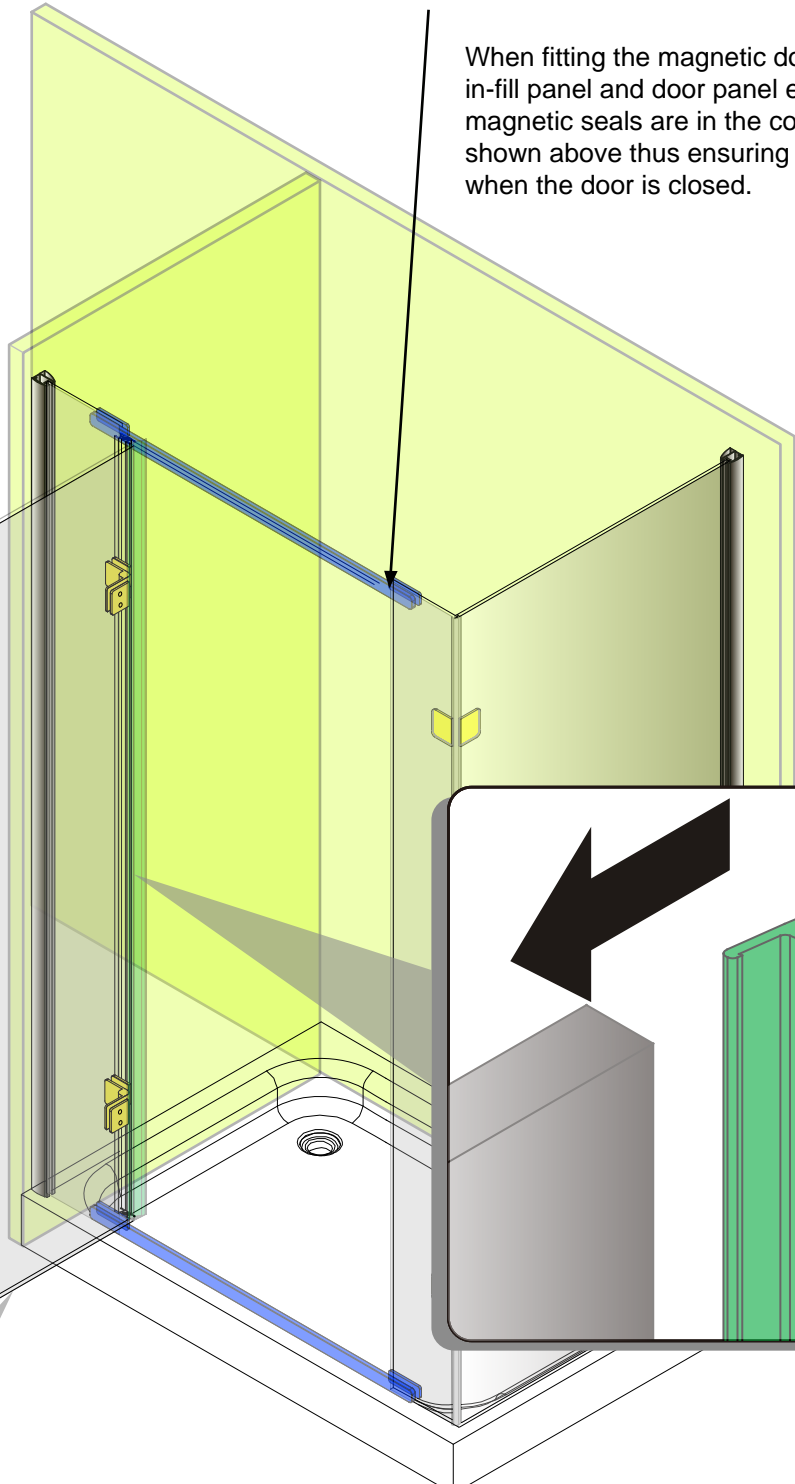
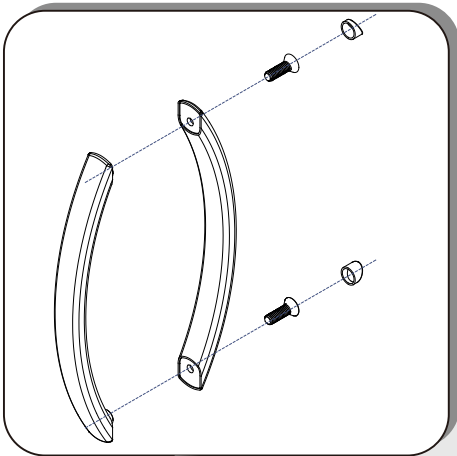

Carefully fit the hinge deflector seal to the door panel making sure that it is fitted the correct way on to the door panel as shown above.

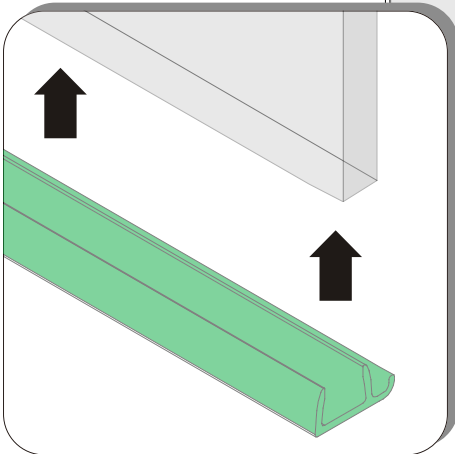

Gently fit the bottom door seal to door panel by gently pushing it into place as shown above. Ensure that it is facing the correct way when fitting.



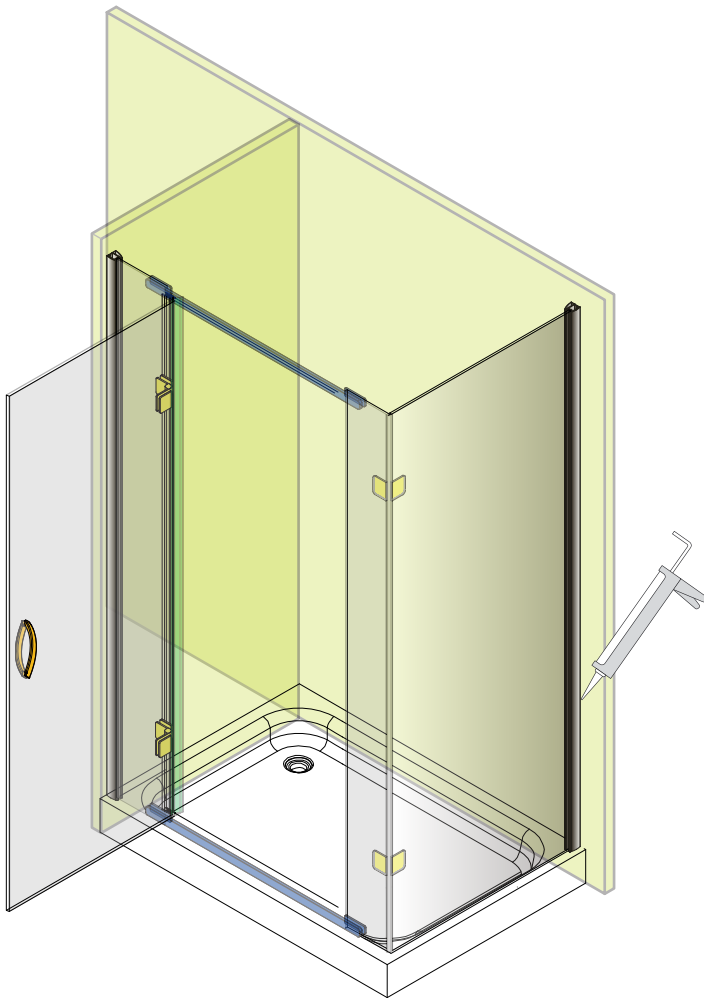

## IMPORTANT

We recommend that you read the sealant packaging for the curing time. Do not use the units until the sealant is set. Please consult with an expert if you are unsure. We recommend that a qualified trades person is used for all plumbing work.

### Applying Silicone Sealant

#### Sealing Inside

Seal from the top of the wall profile to the bottom on the **INSIDE** between the wall profile and the wall.

**IMPORTANT** : Do not apply sealant on inside of tray.

#### Sealing Outside

Seal only along the bottom rail and glass on the **OUTSIDE** between the profile /glass and the tray . Also up between the wall profile and the wall.

Seal also the joints between the bottom profile and any upright profiles.

DO NOT USE THE ENCLOSURE FOR 24 HOURS AFTER SEALING.

**Clean&Clear**<sup>™</sup>  
Easy Clean Glass Treatment

Aftercare

Clean and Clear glass can be cleaned with any suitable non-abrasive glass cleaner can be used-with PH value of between 3-11, the coating will not be damaged. Avoid surfactants and heavily perfumed products. Vinegar and water based products are very effective. Do not use abrasive scrubbing cleaners or equipment for cleaning.