

Sales Code: KCH305SL

Description: Churni Mono Single Lever Chrome

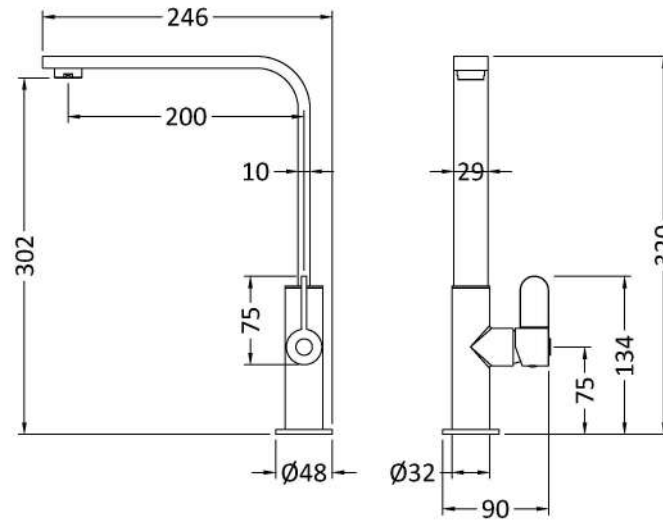

Product Dimensions

Height (mm):	320
Width (mm):	90
Depth (mm):	246
Length (mm):	
Nett Weight (kg):	0.95

Packaging Dimensions

Height (mm):	70
Width (mm):	265
Depth (mm):	415
Gross Weight (kg):	1.39

Packaging Data

Box Colour:	Brown Cardboard Box
Box Qty:	0
Label Size:	0 x 0
Label Colour:	White Label
Label Qty:	0

Outer Box Dimensions (If Applicable)

Height (mm):	370
Width (mm):	280
Depth (mm):	395
Length (mm):	
Gross Weight (kg):	5
Barcode:	5056678400623

Product Details

Country of Origin:	China
Fitting Instruction:	No
Product Material:	Brass
Control Type:	Manual
Waste Included:	Waste Not Included
Waste Type:	Not Applicable
WRAS Approval: No	Approval No: N/A
Valve/Cartridge Type:	1/4 Turn Ceramic Disc
Colour/Finish:	Chrome
Mount Type:	Deck
Operating Pressure (bar):	0.5

Flow Rates: (Litres Per Min) 0.1 bar: 1.8 0.5 bar: 3.4 1 bar: 4.6 2 bar: 6.3 3 bar: 7.7

Pipe Size: 15 mm (1/2" Bsp)

Pipe Centres: N/A