

# WETROOM SCREEN INSTRUCTION

THIS INSTRUCTION COVERS MULTIPLE APPLICATIONS (SOME PARTS ARE OPTIONAL).

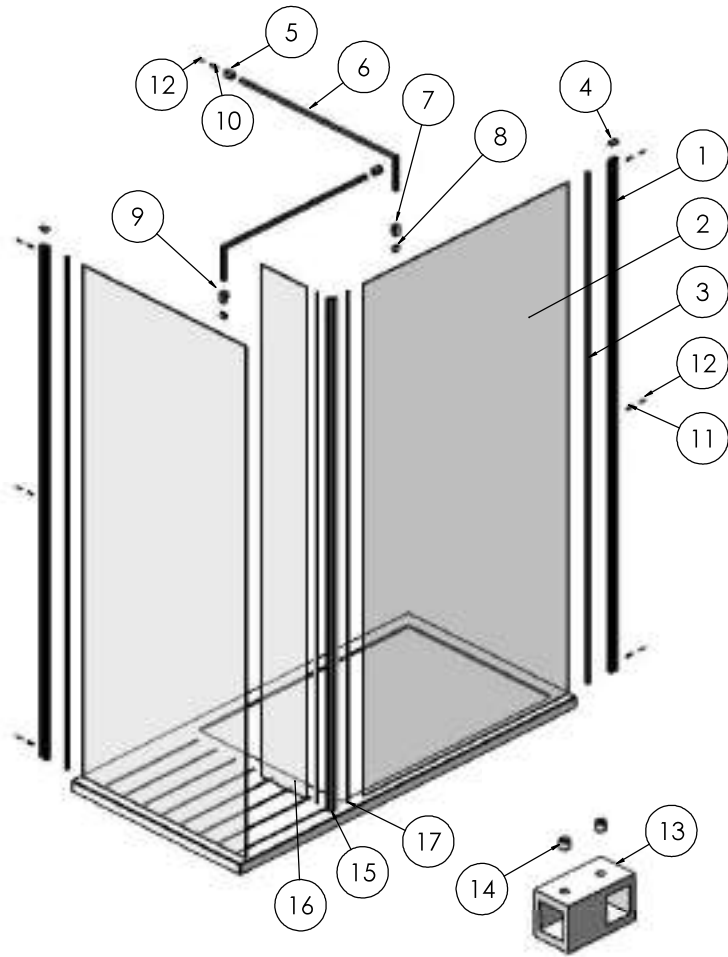

UNPACK THE BOX AND ENSURE ALL COMPONENTS ARE PRESENT.

NO REFUNDS OR REFITTING COST WILL BE GIVEN IF INCOMPLETE OR DAMAGED GOODS ARE FITTED.

THE TOUGHENED SAFETY GLASS IS MANUFACTURED TO SPECIFICATION EN12150-1 AND SHOULD BE HANDLED WITH CARE AS IMPACTS CAN DAMAGE THE GLASS AND CAUSE IT TO FAIL AT A LATER DATE.

FIT THE SHOWER TRAY AS PER THE MANUFACTURERS INSTRUCTIONS.

NOTE: IF THE TRAY ISN'T TRUE AND LEVEL, IT MUST BE RECTIFIED BEFORE SILICONING AROUND THE TOP EDGE OF THE TRAY WHERE IT MEETS THE TILES. ALLOW THE SILICONE TO DRY BEFORE FITTING THE ENCLOSURE.

## TOOLS REQUIRED

POWER DRILL - 6mm MASONRY DRILL BIT - CROSS HEAD SCREW DRIVER - TAPE MEASURE - PENCIL - SILICONE GUN WITH SANITARY GRADE SEALANT - SPIRIT LEVEL.

FOR A SINGLE SCREEN			
ITEM	DESCRIPTION	Notes	QTY
1	WALL PROFILE		1
2	SHOWER WALL GLASS		1
3	PUSH IN 'V' SEAL		1
4	WALL PROFILE CAP		1
5	TOP BAR WALL SOCKET		1
6	TOP BAR		1
7	GLASS CLAMP		1
8	PVC SADDLE		1
9	GRUB SCREW		4
10	30mm CSK SCREW		1
11	30mm SELF TAPPER SCREW	FOR FIXING TO WALL	3
12	PLASTIC WALL PLUGS		4

WALK-IN 'T' PIECE SOCKET SET			
ITEM	DESCRIPTION	Note	QTY
13	'T' PIECE SOCKET		1
14	GRUB SCREW		2

OPTIONAL RETURN PANEL			
ITEM	DESCRIPTION	Note	QTY
15	CORNER PROFILE		1
16	RETURN GLASS PANEL		1
17	WEDGE SEALS		2

WALK-THROUGH			
ITEM	DESCRIPTION	Note	QTY
N/A	SCREEN SUPPORT FOOT	ONLY COMES WITH WALK-THROUGH SCREENS	1
N/A	SCREEN SUPPORT BAR	MADE UP OF ITEMS: 5, 6, 7, 8, 9, 10 & 12.	1

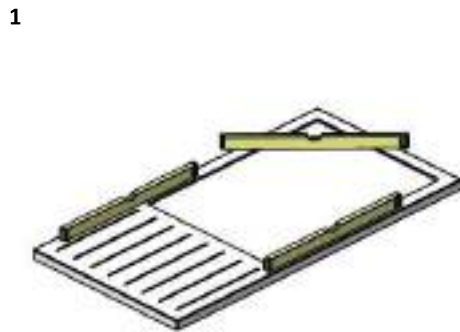

ENSURE THE TRAY IS LEVEL IN ALL PLANES.

IF THE TRAY IS NOT LEVEL IT WILL CAUSE FITTING ISSUES.

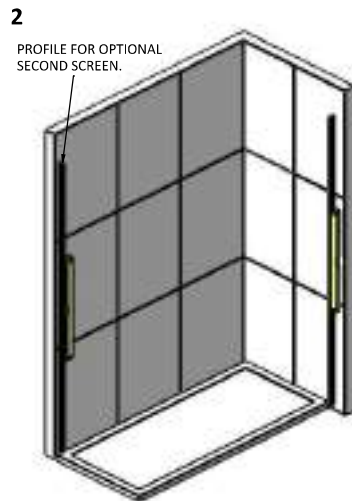

PROFILE FOR OPTIONAL SECOND SCREEN.

POSITION THE WALL PROFILES ON THE TRAY IN A SUITABLE POSITION. MAKE SURE THEY'RE TRUE WITH A SPIRIT LEVEL, THEN MARK THROUGH THE FIXING HOLES WITH A PENCIL. REMOVE PROFILES THEN DRILL AND PLUG THE WALL (ITEM 12). NOW FIX THE WALL PROFILE IN PLACE USING ITEM 11.

BEFORE FIXING ENSURE THAT THE CURVED FACE OF THE PROFILE IS FACING OUTWARDS FROM THE ENCLOSURE.

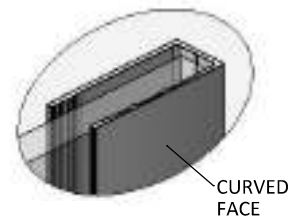

CURVED FACE



RUN A SMALL BEAD OF SILICONE DOWN THE INSIDE OF THE WALL PROFILES BEFORE FITTING GLASS. NOW SLIDE THE GLASS PANELS (ITEM 2) INTO THE PROFILES.

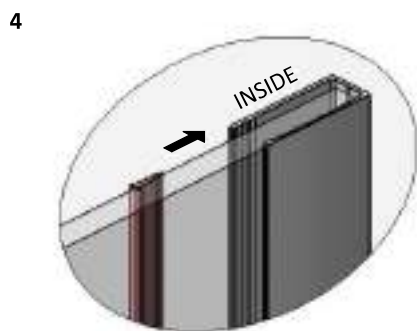

INSERT PUSH IN 'V' SEAL AS SHOWN:

**8mm GLASS**  
ONE THICK SEAL ON THE INSIDE OF THE GLASS PANEL.

**10mm GLASS**  
ONE THIN SEAL ON THE INSIDE OF THE GLASS PANEL.

## 5a WALK-THROUGH CONFIGURATION

NOTE: THE WALL PROFILE IS NOT REQUIRED FOR THIS CONFIGURATION.

ASSEMBLE THE TOP BARS AS PER THE DIAGRAM BELOW.

POSITION THE GLASS PANEL IN THE DESIRED LOCATION AND MARK WITH A PENCIL. PLACE TOP BAR ASSEMBLIES ON TOP OF YOUR SCREEN CUTTING BAR "A" TO REQUIRED LENGTH.

ASSEMBLE THE TOP BAR.

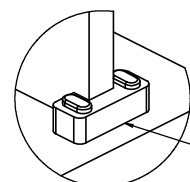

THE SCREEN SUPPORT FOOT ONLY COMES WITH THE WALK-THROUGH WETROOM SCREENS.

THIS CAN ALSO BE PURCHASED SEPARATELY.

100mm RECOMMENDED BOTH SIDES

AN ADDITIONAL SUPPORT BAR COMES WITH THE WALK-THROUGH WETROOM SCREENS.

A

POSITION THE SCREEN SUPPORT FEET EITHER SIDE OF THE GLASS PANEL AND FIT.

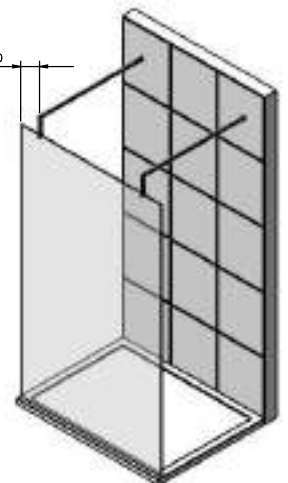

### 5b SINGLE SCREEN

ASSEMBLE THE TOP BAR (SUPPLIED WITH SCREEN) AS PER THE DIAGRAM BELOW FOR A SINGLE SCREEN CUTTING BAR "A" TO REQUIRED LENGTH.

ASSEMBLE THE TOP BAR.

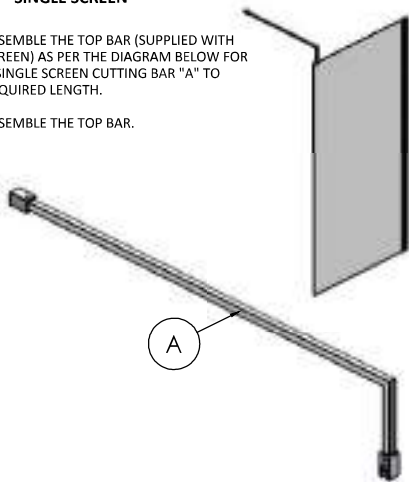

### 5c WALK-IN CONFIGURATION

ASSEMBLE THE TOP BARS (SUPPLIED WITH SCREEN) AS PER THE DIAGRAM ACROSS FOR A WALK-IN CONFIGURATION CUTTING BAR "A" TO REQUIRED LENGTH.

ENSURE BEFORE FIXING THE TOP BAR WALL SOCKET THAT YOU HAVE POSITIONED THE 'T' PIECE SOCKET (ITEM 13) ONTO BAR "A" WITH THE GRUB SCREWS (ITEM 14) FACING UPWARDS.

NOW MEASURE AND CUT BAR "B" TO SUIT.

ASSEMBLE THE TOP BARS.

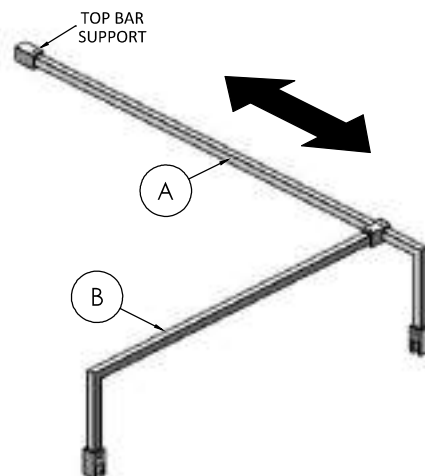
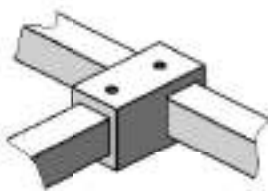

### 6

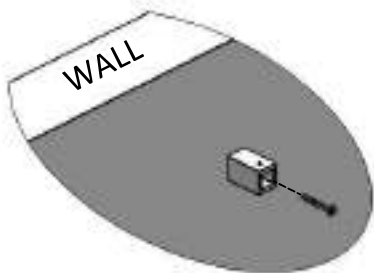

ONCE ASSEMBLED MARK AND DRILL THE TOP BAR WALL SOCKET (ITEM 5). ENSURE THE TOP BAR WALL SOCKET IS LEVEL AND THAT THE GRUB SCREW IS FACING UPWARDS BEFORE FIXING IT TO THE WALL USING ITEMS 10 & 12.

FIT BAR ASSEMBLY.

### 7 OPTIONAL PANEL

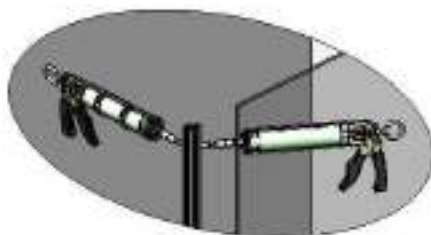

TO FIX THE OPTIONAL GLASS PANEL INTO PLACE, FIRSTLY RUN A SMALL BEAD OF SILICONE DOWN THE INSIDE OF EACH GLASS SLOT ON THE CORNER PROFILE (ITEM 15) STOPPING 5mm SHORT AT EITHER END.

THEN SLOT THE CORNER POST ON TO THE END OF THE SHOWER WALL GLASS (ITEM 2).

### 8 OPTIONAL PANEL

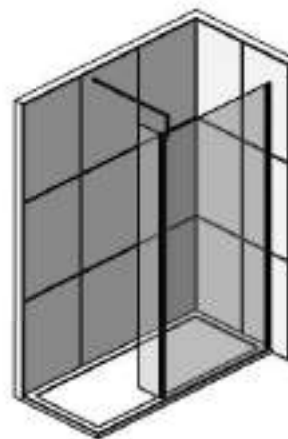

SLIDE THE RETURN GLASS PANEL (ITEM 16) INTO THE CORNER PROFILE (ITEM 15) ENSURING ITS FULLY INSIDE.

### 9 OPTIONAL PANEL

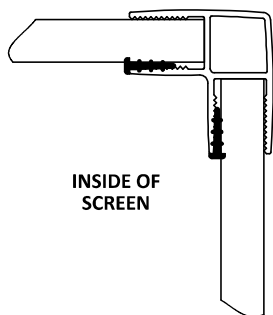

INSIDE OF SCREEN

FINALLY FIT THE WEDGE SEALS (ITEM 17) INTO THE CORNER PROFILE AS SHOWN ABOVE. STARTING AT THE BOTTOM, PUSH THE SEAL ALONG THE LENGTH OF THE PROFILE. A WOODEN BLOCK CAN BE USED TO AID FITTING. TRIM OFF ANY SURPLUS SEAL AT THE TOP SO ITS EVEN WITH THE PROFILE.

### 10

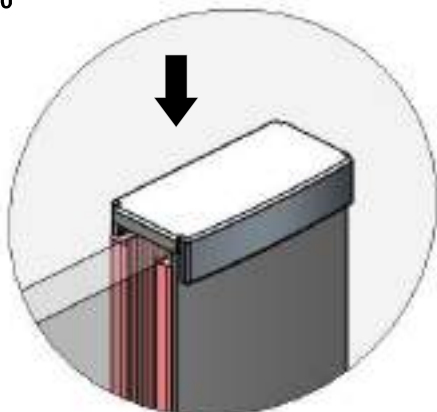

FIT THE WALL PROFILE CAP(S) (ITEM 4). A SMALL BLOB OF SILICONE CAN BE APPLIED TO THE UNDERSIDE OF THE CAP TO HOLD IT IN PLACE IF NECESSARY.

### 11

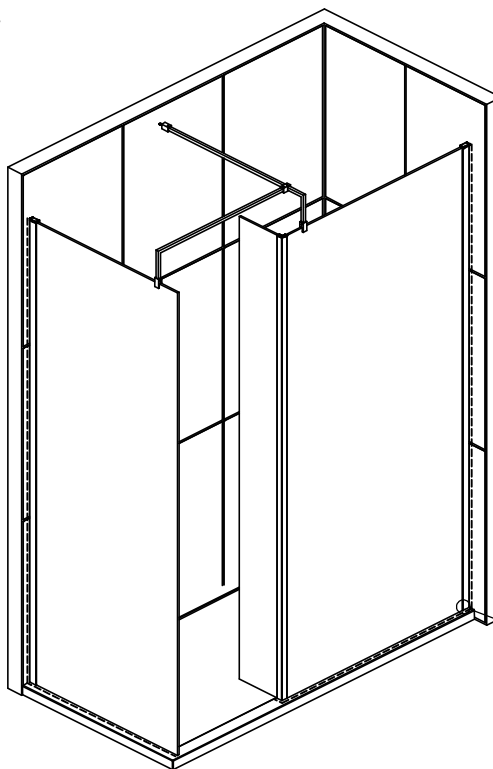

EXTERNALLY SILICONE SEAL THE WALL PROFILE WHERE IT MEETS THE WALL AND ALONG THE BOTTOM OF THE GLASS. ALL IN A CONTINUOUS BEAD.

DO NOT SILICONE INSIDE THE ENCLOSURE.

ALLOW THE SILICONE AT LEAST 24 HOURS TO FULLY CURE.

**AFTERCARE** - ENSURE YOU CLEAN YOUR PRODUCT USING A MILD DETERGENT DILUTED IN WATER, REMOVING ANY RESIDUE WITH A SOFT DAMP CLOTH.

**MAINTENANCE** - ENSURE PARTS ARE FREE FROM ANY DEBRIS OR SOAP BUILD UP.

#### TROUBLE SHOOTING GUIDE

1. IS THE TRAY LEVEL (SEE STEP 1).
2. ARE THE WALL PROFILES PLUMB VERTICALLY (SEE STEP 2).
3. DO THE FINISHED TRAY MEASUREMENTS COMPLY WITH THE ADJUSTMENTS LISTED IN THE PRODUCT SPECIFICATION.

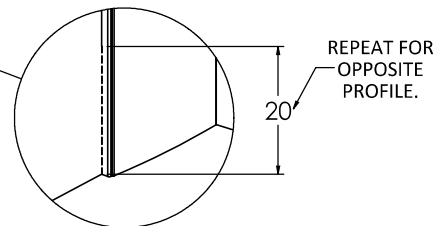

WALK-THROUGH CONFIGURATION