

BRISTAN

Installation Instructions & User Guide

Please leave these instructions with the end user

Product Code: MI 3/4 BLK (D2)

Specifications

Inlet Water Temperature

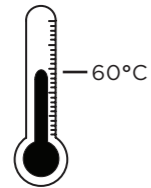

Maximum: 60°C

Dynamic Water Pressure

Min: 0.2 bar

Max: 5.0 bar

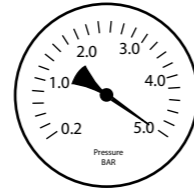
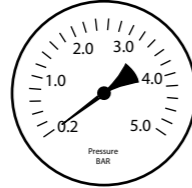

Maximum Static Pressure: 10.0 bar

Inlet Connections

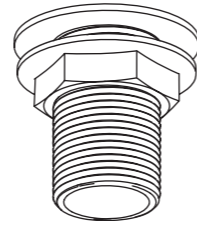

3/4" BSP

Tools You'll Need



Adjustable Spanner

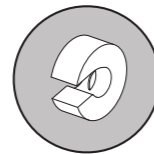

Pipe Cutter



Outlet Key

Prior to Installation

All products manufactured and supplied by Bristan are safe to use provided that they are installed, operated and receive regular maintenance in accordance with these instructions.

This product needs to be installed in accordance with, and meet the requirements of the Water Supply (Water Fittings) Regulations 1999 and current by-laws. For full Installation Requirements & Notes (IRN) please visit wras.co.uk/directory.

Isolation valves must be fitted to the inlet water supplies to ensure ease of future maintenance.

Before installing this product the water supply must be thoroughly flushed in order to remove any swarf, solder etc. Full access must be made available for future maintenance/servicing purposes.

This product must not be modified in any way as this will invalidate the guarantee.

If in doubt, contact a registered plumber, your Local Water Authority or the Secretary of the Institute of Plumbing, address as follows:-

The Institute of Plumbing,
64 Station Lane,
Hornchurch,
Essex,
RM12 6NB, Tel: 01708 472791

Pack Contents

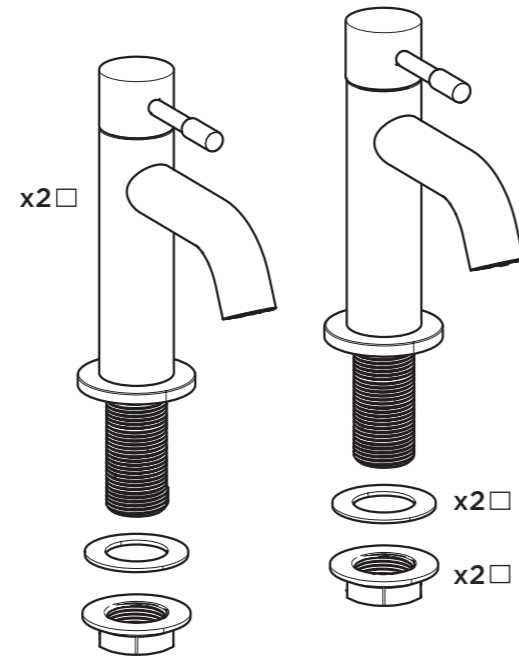

Spare Parts

To replace any spare parts for your tap, why not scan the QR Code or visit www.bristan.com and search for your product.



Installation

1

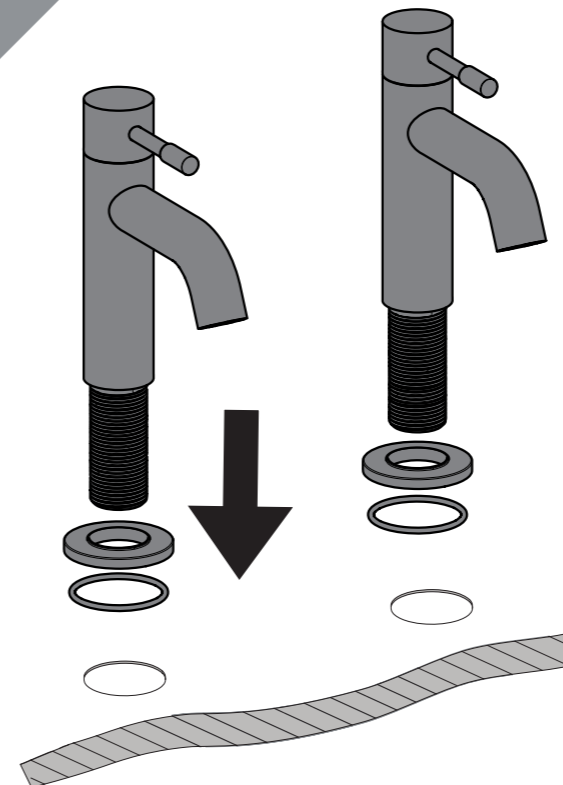

Fit the taps to the bath, ensuring the plinth are in place.

2

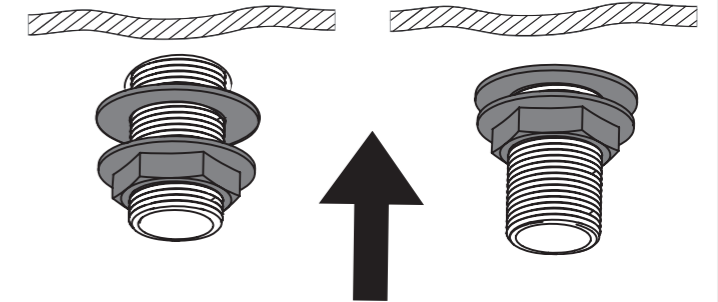

Secure the taps to the bath by using the washer and metal backnut below the bath.

3

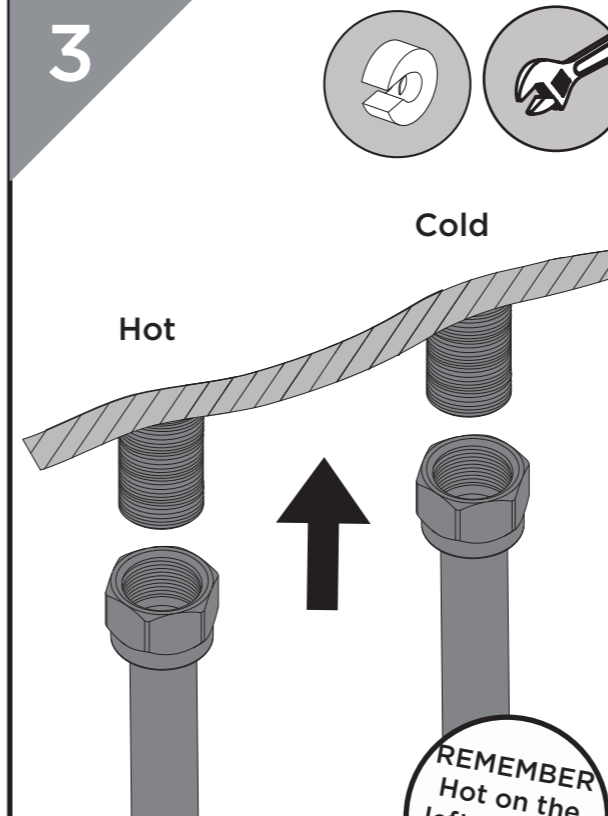

Connect the hot and cold water supplies to the threaded tails.

REMEMBER
Hot on the left, cold on the right!

Operation

4

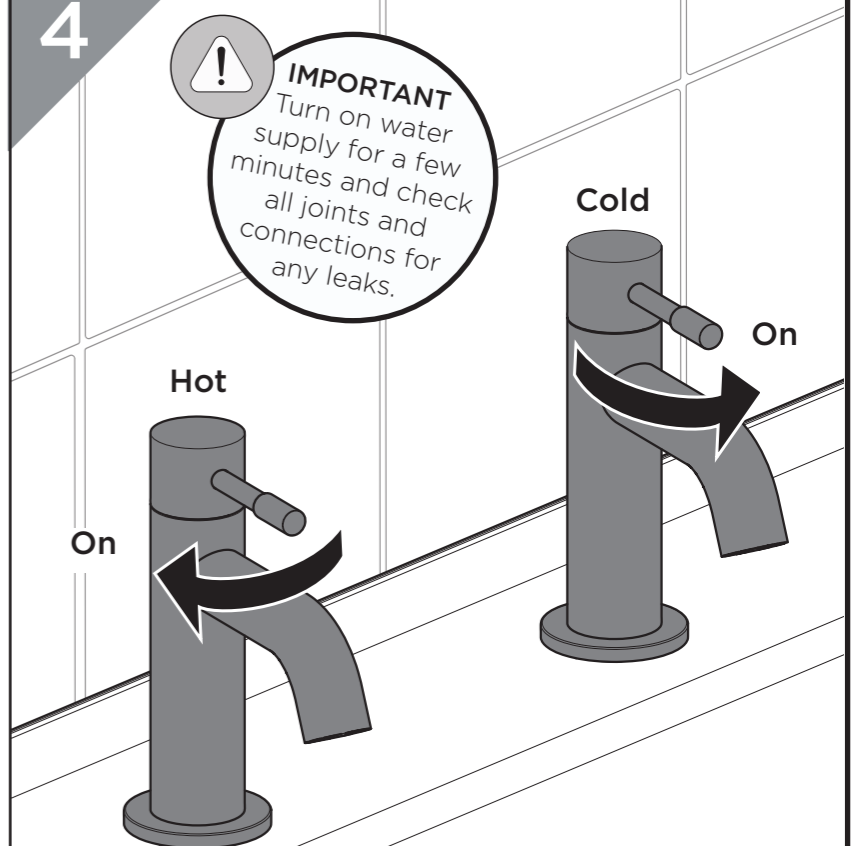

IMPORTANT
Turn on water supply for a few minutes and check all joints and connections for any leaks.

Hot

On

Cold

On

Maintenance - Clean/Replace Outlet

1  **IMPORTANT**
Isolate the water supply before starting!

2 Check for damage. Soak using a suitable solution to de-scale.

Using outlet key (not included), unscrew gently to remove the outlet.

Screw back into the tap body to replace the outlet.

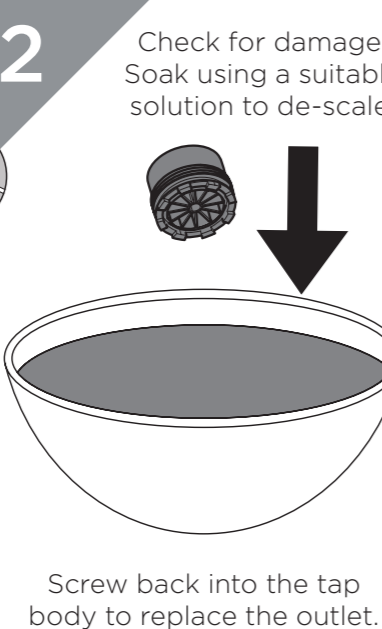

General Cleaning

Bristan products are made from premium materials, with hand polishing and electroplated finishes.

Your taps or shower should be regularly cleaned with warm water, a mild pH-neutral liquid soap, and polished with a soft cloth. Any residues from soap, toothpaste, shampoos and shower gels can cause blemishes if not rinsed off straight after use.

Household bleaches and cleaners contain harsh chemicals and may damage the surface finish. Avoid using abrasive cloths, scouring pads, scrub sponges, steel wool or anything similar.

Some surfaces such as nickel and pewter may be affected by the dye found in some cloths, so it is also important to avoid hanging cloths on spouts.

Troubleshooting

Symptom	Cause	Remedy
No flow or low flow rate	Partially closed isolation valve.	Open isolation valve.
	Instantaneous water heater cycles on and off as flow rate or pressure is too low.	Increase water flow rate or pressure through system.
	Head of water is below the minimum distance required.	Refer to specification for minimum distance required.
	Hot or cold water being drawn off elsewhere causing pressure changes or instantaneous boiler temperature changes.	Do not use other water outlets when using the taps.
	Airlock or partial blockage in the supply pipework.	Flush through pipework to ensure removal of debris and any airlocks.
Water dripping from taps	This is normal for a short time after using the taps.	This is caused by residual water tension, the build up of water in the tap body.
	If water continues to drip, possibly due to the ceramic disc valves	Remove valves and clean, refer to 'Maintenance' section before starting any maintenance.
Taps do not turn on	Closed isolation valve.	Open isolation valve.
	Mains water supply turned off.	Turn on mains water supply.

Maintenance - Valve Cleaning

1 Unscrew handle lever and pull of handle.

2  **IMPORTANT**
Isolate the water supply before starting!

Unscrew the valve using an adjustable spanner. Check any seals and O-rings for damage. Replace valve if necessary.

3 Place valves in a suitable solution and soak until fully de-scaled.

4 Reverse the steps to replace the valves and handles.

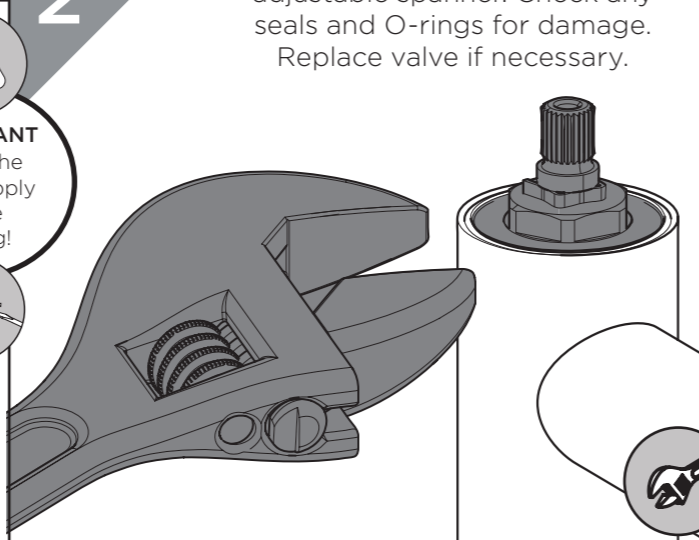

Notes

Contact Us

BRISTAN

Bristan Group Ltd.

UK: Bristan Group, B78 1SG.

EU: Masco Europe S.à.r.l.
14 Rue Strachen
6933 Mensdorf
Luxembourg

Customer Service: +44330 026 6273

Web: www.bristan.com

Email: enquire@bristan.com

A Masco Company

Our Guarantee

At Bristan, we want to make things as easy as possible for our customers. That's why we offer solid guarantees on all our products, effective from the date of purchase, to give you peace of mind.

To start your free guarantee simply scan the QR code and register your product. Alternatively visit www.bristan.com/register.

For any other queries, please call our Customer Service on 0330 026 6273 where our expert team of advisors will be able to offer you any help and advice.

For full guarantee terms and conditions visit www.bristan.com/service-centre/guarantees.

