

Electric Towel Rail

Instruction Manual



GIA

Table of contents

1. Safety & Warnings

2. Technical Specifications

3. Installation Instructions

- 3.1 Fixings
- 3.2 Installation

4. Control Panel

- 4.1 Standby Mode
- 4.2 Mode Switch
- 4.3 Child lock
- 4.4 Supplementary functions
- 4.5 Reset to Defaults

5. Connecting to WiFi

- 5.1 Downloading the App
- 5.2 Connecting to the App
- 5.3 Adding Devices

6. Using the APP

- 6.1 Home Overview
- 6.2 Control Interface
- 6.3 Choose Mode

7. Device Setting

- 7.1 Child Lock
- 7.2 Temperature Compensation
- 7.3 Open Window Detection
- 7.4 Temperature Unit

8. Disposal

**Read this manual carefully before using or installation the device.
Keep the manual for future reference.**

 **Warning: This device must be installed by a licensed electrician.**

1. SAFETY & WARNINGS

- This appliance can be used by children aged from 8 years and above and persons with reduced physical, sensory or mental capabilities or lack of experience and knowledge if they have been given supervision or instruction concerning the use of the appliance in a safe way and understand the hazards involved. Children shall not play with the appliance. Cleaning and user maintenance shall not be made by children without supervision.
- Children of less than 3 years should be kept away unless continuously supervised. Children aged from 3 years and less than 8 years shall only switch on/off the appliance provided that it has been placed or installed in its intended normal operating position and they have been given supervision or instruction concerning use of the appliance in a safe way and understand the hazards involved. Children aged from 3 years and less than 8 years shall not plug in, regulate, or clean the appliance, or perform maintenance.
- Do not use the device in enclosed spaces if persons are present who cannot leave the room independently and are not under constant supervision
- In order to avoid overheating, do not cover the radiator.
- In order to avoid a hazard due to inadvertent re-setting of the thermal cut-out, this appliance must not be supplied through an external switching device, such as a timer, or connected to a circuit that is regularly switched on and off by the utility.
- Some parts of this product can become very hot and cause burns. Do not touch the surface when in operation. Do not install close to curtains or other combustible materials. Particular attention should be given where children and vulnerable adults are present.
- Keep the power cable away from all hot parts of the appliance.
- Do not use the device if you detect damage to the mains plug or power cable. If the supply cord is damaged, it must be replaced by the manufacturer, its service agent or similarly qualified persons to avoid a hazard.
- All repairs and servicing must be carried out by a qualified person. To avoid danger any repairs must be completed by the manufacturer, a service agent of the manufacturer or a similarly qualified person.
- Make sure the voltage indicated on the rating plate for this appliance corresponds to your power outlet.
- Do not use this device in the immediate surroundings of a bath, shower, swimming pool or any other water container. Risk of electric shock.
- The device must not be located immediately below an electrical socket outlet.
- Do not use the device with wet or damp hands.
- No part of the appliance should be submersed in any type of liquid.
- Cleaning should be carried out using a damp cloth only. No abrasive chemicals or materials should be used.
- Never insert fingers or other objects or body parts into the device. Risk of electric shock or injury.
- Do not use any accessories with this device. Use of accessories may cause damage or danger.
- Keep the device at a minimum distance of one metre from curtains and other flammable materials.

- The device must only be installed in an upright and fixed position in accordance with national installation rules.
- The device is for indoor use only.
- Do not use the radiator with a programmer, timer, separate remote control system or any other device that switches the heater on automatically, since a fire risk exists if the heater is covered or positioned incorrectly.
- Make sure the minimum safety distances from walls and objects stated in the installation instructions are observed at all times. This is very important to prevent damage to walls, furniture and soft furnishings and to prevent the product overheating.
- Do not use the device in rooms where contact with flammable or potentially explosive materials like dust, gas or vapour cannot be avoided.
- Do not use in rooms or environments that have a corrosive atmosphere.
- Do not operate the device when wet. If the device gets wet during cleaning, allow it to dry out before using.
- Do not expose the device to water jets.
- Do not transport the device during operation.
- Do not sit on the device.
- Do not overload the socket used to power the device.
- Before carrying out maintenance, care or repair work on the device, ensure the device is unplugged. Do not use the cable to tug the plug from the socket. Hold the plug by its housing and pull.
- Switch the device off and disconnect the power cable from the mains socket when the device is not in use.
- Allow the device to cool down before touching or transporting the device, or attempting maintenance work.
- The device must be placed where the switches and controllers cannot be touched by a person in a bathtub or shower.

2. TECHNICAL SPECIFICATIONS

Series	GIA
Model No.	DE-GIA0785 (780*550mm)
	DE-GIA1025 (1100*550mm)
Voltage	230V AC / 50Hz
Wattage	500W, 750W
Temperature setting	7–30 °C
IP rating	IP24
Appliance class	Class I
Power cable length	1.5m
WiFi frequency (2.4G band) Operation frequency Max RF power transmitted	2400-2483.5MHz 17.21dBm (52.6mW) < 20dBm (100mW)

3 INSTALLATION

3.1 Fixings

Before installing, check that all fixings are complete, and the product is intact. The towel rail should only be wall mounted with the manufacturer's fixings.

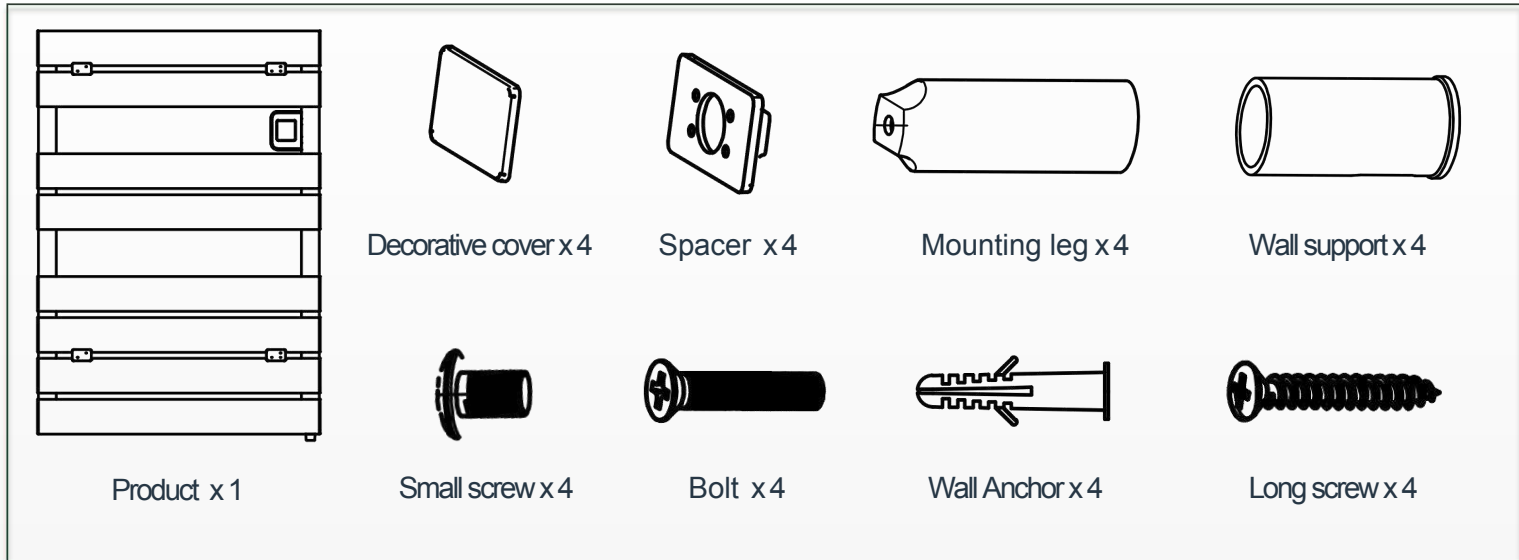

Distance between the center points of each wall bracket tube.

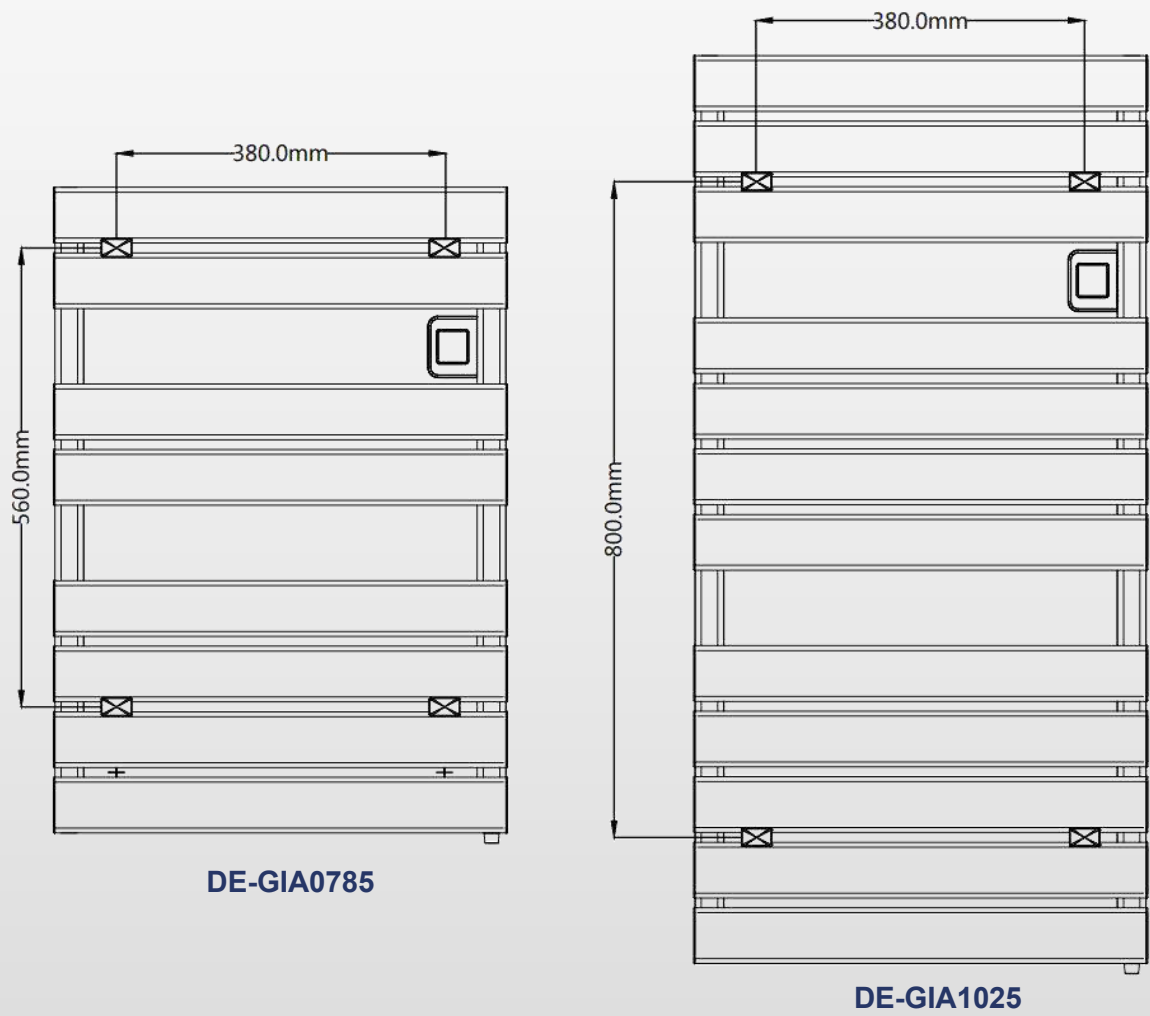

3.2 Installation

STEP 1

Fix four spacers to four mounting legs, screw down the bolts with a screwdriver and put the decorative covers on it.

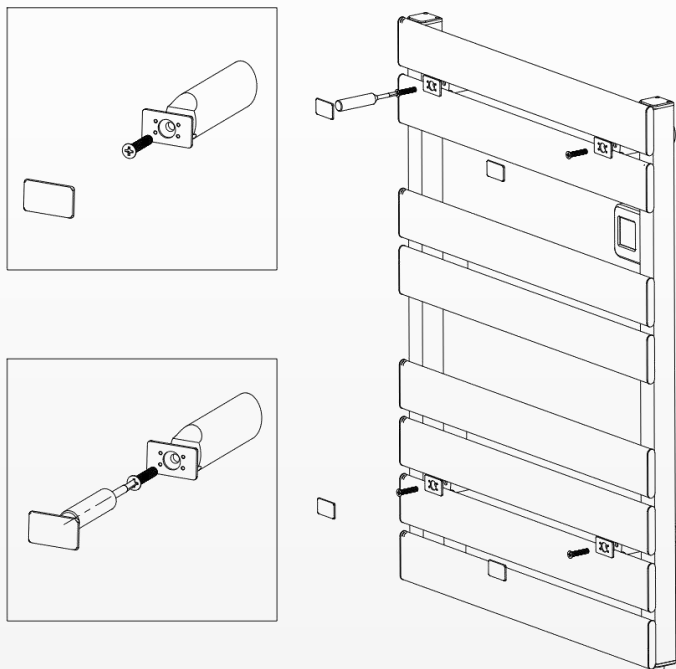

STEP 2

Choose the desired position and mark it with a pencil. Then use an electric drill to make four holes and insert wall anchors into the wall. Secure the wall supports to wall with four long screws.

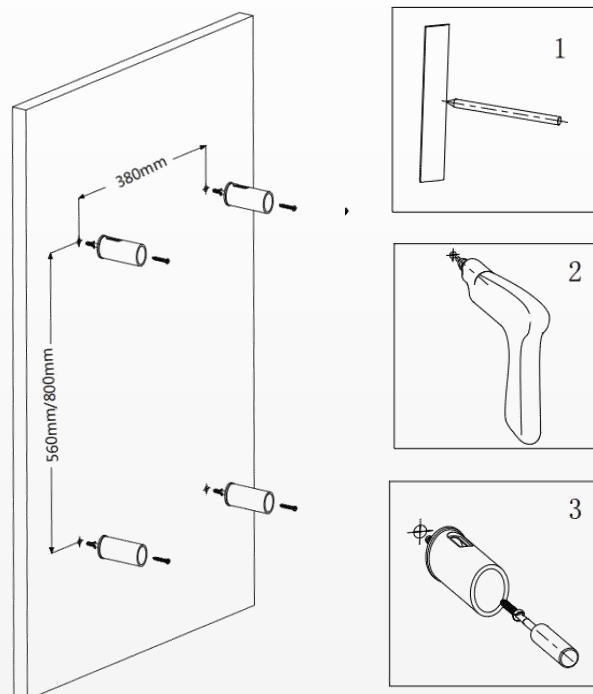

STEP 3

Mount the towel rail to the wall and tighten the small screws in the wall supports.

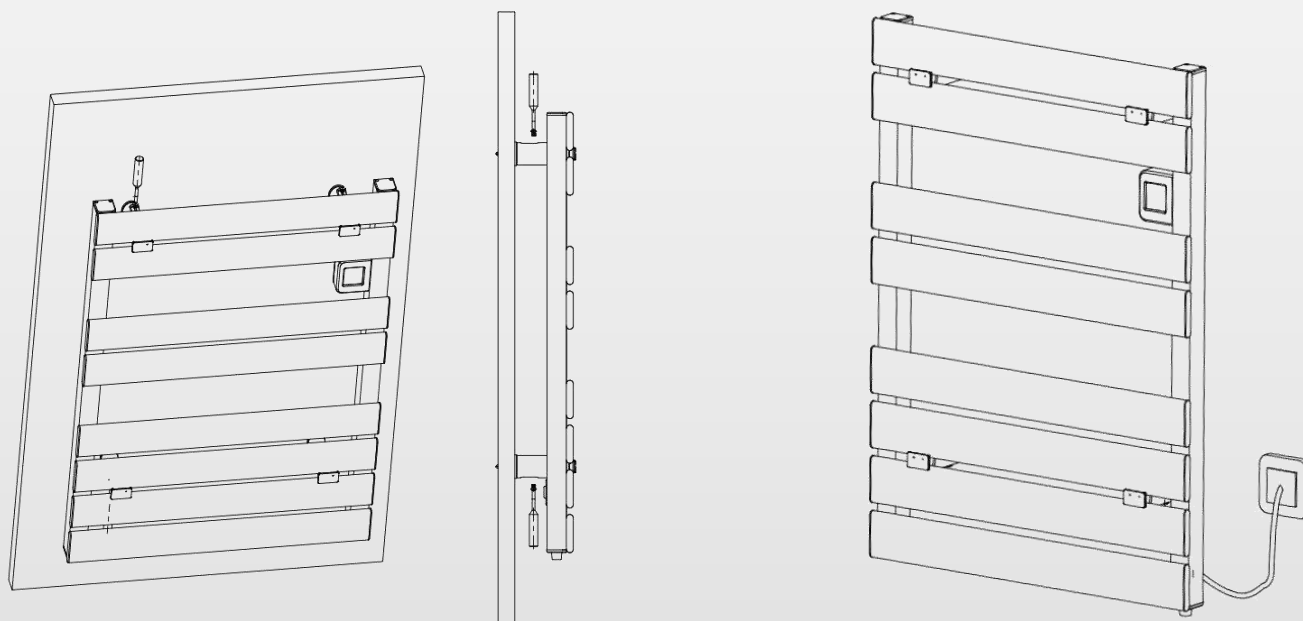

Warning: To prevent potential safety hazards, it is recommended that grounding and short circuit measurements be performed after installation of the device. This should be done by a licensed electrician.

4. CONTROL PANEL

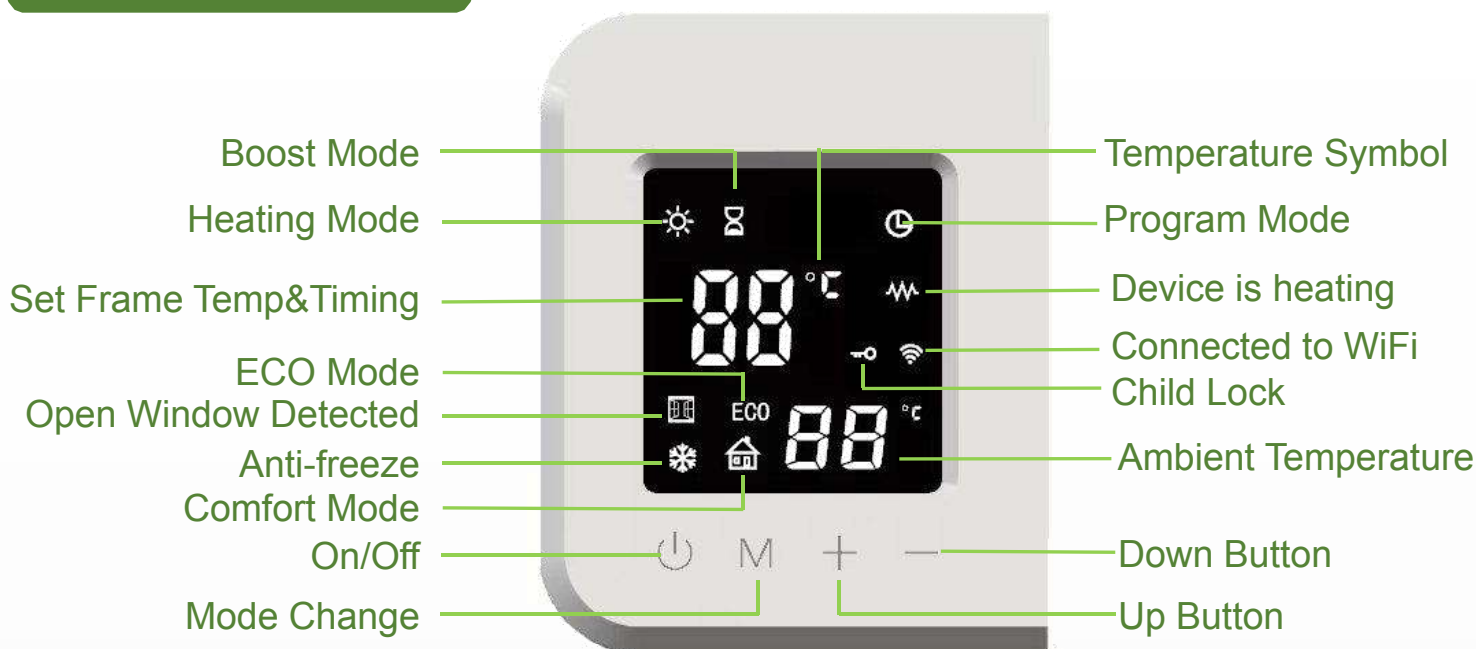

The controller has below functional modes:

4.1 Standby Mode

4.2 Mode Switch

- 4.2.1 Heating Mode
- 4.2.2 Boost Mode
- 4.2.3 Program Mode
- 4.2.4 Comfort Mode
- 4.2.5 Eco Mode
- 4.2.6 Anti-Freeze Mode

4.3 Child unlock

4.4 Supplementary functions

- 4.4.1 Temperature Compensation
- 4.4.2 Open Window Detection
- 4.4.3 °C/°F switch
- 4.4.4 WIFI on/off

4.5 Reset to Defaults

4.1 Standby Mode

After the heater has been plugged in, press the  button to power on state.

4.2 Mode Switch

Press the **M** button to change the mode.

Cycle through: Heating mode → Boost mode → Program mode → Comfort mode → ECO mode

4.2.1 Heating Mode--Frame Temp

- Press the **M** button to enter the heating mode. The default set temp is 50°C.
- Set temperature can be adjusted by using the **+** and **-** buttons. The range is 30-70°C in steps of 5°C. Press and hold the button to speed up.
- Symbol  will be displayed in orange when heating and disappear when it is not heating.





4.2.2 Boost Mode

- Press the **M** button to enter the boost mode. The device will stay working at the setting boost hours at maximum performance 70°C. The default set is 2H.
- Set time can be adjusted by using the **+** and **-** buttons. The range is 1-8H in steps of 1H. Press and hold the button to speed up.
- Symbol  will be displayed in orange when heating and disappear when it is not heating.
- After heating at the setting hours, the device will be power off.



4.2.3 Program Mode

- Press the **M** button to select the program mode. When the icon  displays on the screen, you are in program mode.
- The default set is ECO mode for each day. It can be programmed only by the App.
- Symbol  will be displayed in orange when heating and disappear when it is not heating.



4.2.4 Comfort Mode--Ambient Temp

- Press the **M** button to enter the comfort mode. The default set temp is 19°C.
- Set temperature can be adjusted by using the **+** and **-** buttons. The range is 7-30°C in steps of 1°C. Press and hold the button to speed up.
- Frame temperature limit: If the internal temperature of the frame reaches 70°C, the device will stop heating.
- Symbol  will be displayed in orange when heating and disappear when it is not heating.



4.2.5 Eco Mode--Ambient Temp **ECO**

- Press the **M** button to enter the Eco mode. The default set temperature is 19°C.
- Set temperature can be adjusted by using the **+** and **-** buttons. The range is 7-30°C in steps of 1°C. Press and hold the button to speed up.
- Frame temperature limit: If the internal temperature of the frame reaches 55°C, the device will stop heating.
- Symbol  will be displayed in orange when heating and disappear when it is not heating.





4.2.6 Anti-Freeze Mode

When the sensor detects the temperature below 7°C while the device is powered off, it will enter anti-freeze mode and heat up to 7°C to prevent frost.

4.3 Child Lock

Use this function to prevent any change in the thermostat setting.

Press and hold the **+** and **-** buttons for 3 seconds to lock the display. The  icon will appear and all buttons will be locked except the standby button . Repeat the same procedure to unlock it.



4.4 Supplementary functions

The settings menu allows you to enable, disable and configure all the device's supplementary functions. Press **⏻** to put the towel rail into standby mode and hold down **+** for 10 seconds to enter the settings menu. Press **M** button to switch functions: Temperature compensation(F0)→Open window detection(F1)→°C/°F switch(F2)→WiFi on/off(F3)

4.4.1 Temperature Compensation (F0)

The temperature compensation setting allows users to adjust for any discrepancy between the average room temperature and the temperature sensed by the thermostat. For instance, if the temperature in the room is 18°C, but the radiator is sensing 16°C, a compensation factor of +2°C will offset the difference.

- Press the **+** or **-** to adjust. The setting range is from -5~5°C in steps of 1 °C (The default set is 0°C).

4.4.2 Open Window Detection (F1)

This function enables the automatic detection of an open window when the device is working.

- Press the **+** or **-** button to select, there are three options for the open window detection function: oF, 60 minutes and 90 minutes (The default set is oF).
- If the device detects a sudden drop in temperature (2°C or more within 5 minutes), it will switch to anti-freeze temperature(fixed 7°C) for 60/90 minutes to prevent energy wastage as heat escapes through the window.
- It will revert back to the previous mode after heating for 60/90 minutes. If the temperature drops by 2°C within 5 minutes again, the device will continue to switch to anti-freeze temperature(fixed 7°C), then cycle through.

4.4.3 °C/°F switch (F2)

This function enables to switch between Celsius and Fahrenheit.

- Press the **+** or **-** to switch. Press **+** to select °F, and press **-** to select °C. (The default set is °C).



4.4.4 WIFI on/off (F3)

This setting allows you to enable or disable the device's connection to WiFi. Disabling the connection is temporary: if you have already added the device to your app account, disabling the connection will not remove it. You will be able to control via the app as soon as you re-enable the connection.

- Press the **+** or **-** to switch. Select "oN" to enable and "oF" to disable. (The default set is oN).



4.5 Reset to Defaults

Press  to put the device in standby mode. Press and hold the  key for 10 seconds to restore the device to default settings. The full screen will be displayed for 3 seconds and enter to power off state. Press  to turn on. The heating mode temperature is 50°, the boost mode is 2H, the program mode restores to the default setting, the comfort mode temperature is 19°C, the Eco temperature is 19°C, the temperature compensation is "0", and the open window detection is "oF", the temperature symbol is "°C", WIFI function is "on".

5. CONNECTING TO WIFI

5.1 Downloading the App

Download the APP onto your smart phone. You can find the app by scanning the QR code below or searching "INOW" in the Google Play or Apple app store. Install and follow the app's instructions to create an account.



INOW

5.2 Connecting to the App

To put the device in pairing mode, press  to enter power off mode and hold down **M** button for 3 seconds until the screen switches to the connection screen. This begins a 99 seconds count down, giving you 99 seconds to make the connection on the app.



5.3 Adding devices



Click "Add device"

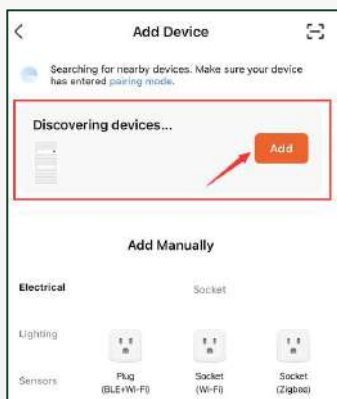

Click "Auto scan"

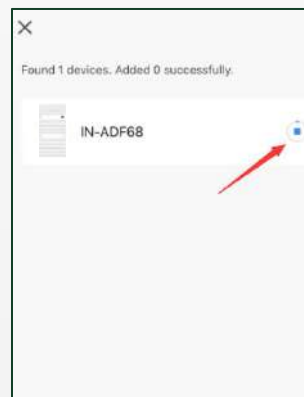

Click "Add"



Enter your WiFi passwor

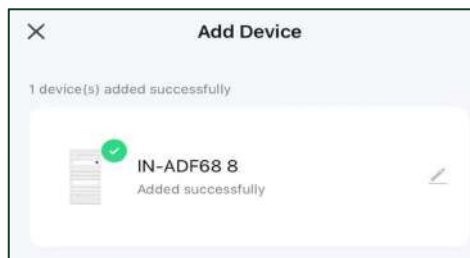

Begin connecting and added successfully

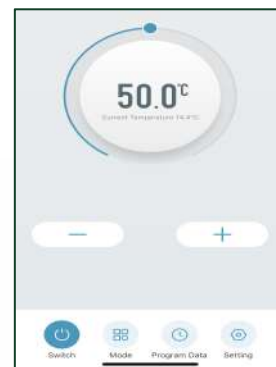

If the device successes to connect, "PS" will be shown on the display.

If the device fails to connect, "FL" will be shown on the display.

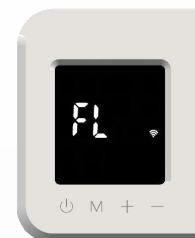

Troubleshooting

Problem	Action
the thermostat sensor has become disconnected	Er is displaying

6. USING THE APP

6.1 Home Overview

You can use the INOW app to control multiple devices. All devices are displayed on the home screen with their status.

Possible statuses:

- Online – Heater will respond to app commands.
- Offline – Device is turned off at wall or power switch. It cannot be controlled by the app.

6.2 Control Interface

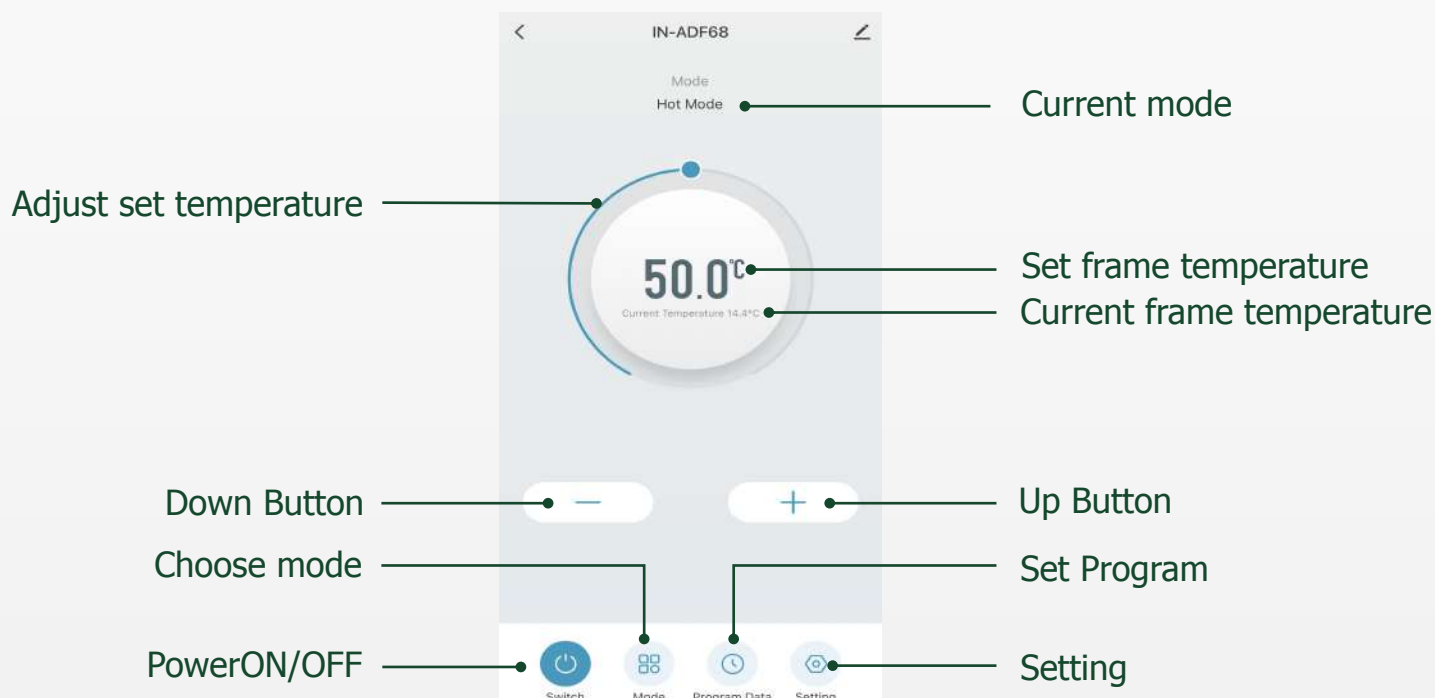

6.3 Choose Mode

Tap the mode button on the interface to choose mode. The five options correspond to the five modes on the control panel. Hot, Boost, Program, Comfort, Eco mode.

6.3.1 Heating mode, Comfort mode & Eco Mode

In heating, comfort and Eco mode, simply use the sliding dial to adjust the set room temp.

6.3.2 Boost Mode

If you need a short boost maximum heating performance, then select the boost mode, 1-8 hours options are available. Under the boosting, the mode can not be changed and the temperature will be fixed at 70°C. After complete the working set hours, it will come back to previous working mode automatically.

6.3.3 Program Mode

Tap the program data icon on the control interface to configure a program.

A program consists of 24 hourly intervals for each day, which you can set to Comfort, Eco or Anti-freeze temperature.

Tap the interval to choose Comfort (yellow bar), Eco (green bar) or Anti-freeze (blue bar). You can drag the start and end times of each mode block to make setting your program quick and easy.

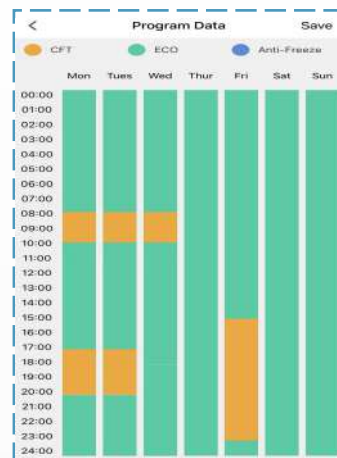
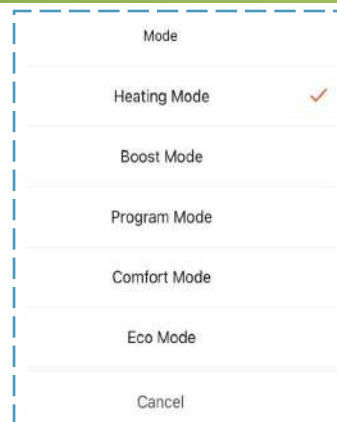

7. DEVICE SETTINGS

Tap the setting icon to view and adjust the device's settings. This menu allows you to configure several settings not available through the control dial.

7.1 Child Lock

Use the toggle switch to lock or unlock the radiator display.  displays on the screen when the device is locked.

7.2 Temperature Compensation

You can adjust the temperature compensation in steps of 1 °C, from -5 ~5 °C.

7.3 Open Window Detection

The  icon will appear and the device will switch to anti-freeze temperature to prevent energy wastage as heat escapes through the window.

7.4 Temperature Unit

You can select the temperature scale between Celsius and Fahrenheit.

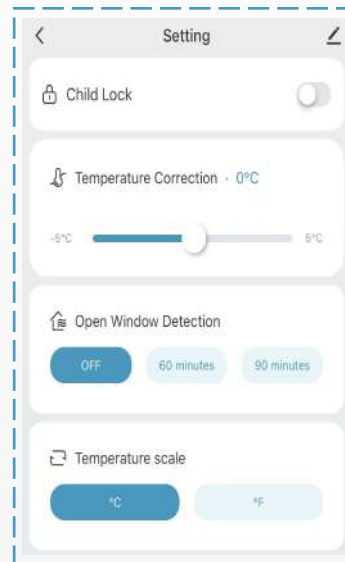

8. DISPOSAL



In accordance with WEEE Directive 2012/19/EU, the icon with the crossed-out waste bin on electrical or electronic equipment stipulates that this equipment must not be disposed of with household waste at the end of its life. You will find collection points for free return of waste electrical and electronic equipment in your vicinity. The addresses can be obtained from your local authority.

The separate collection of waste electrical and electronic equipment enables the re-use, recycling and other forms of recovery of waste equipment, and prevents any negative effects for the environment or human health.