

Sales Code: NLT61053

Barcode: 5056462656366

Brand: nuie

Description: 1600 x 800mm Slate Rectangular Slimline Shower Tray

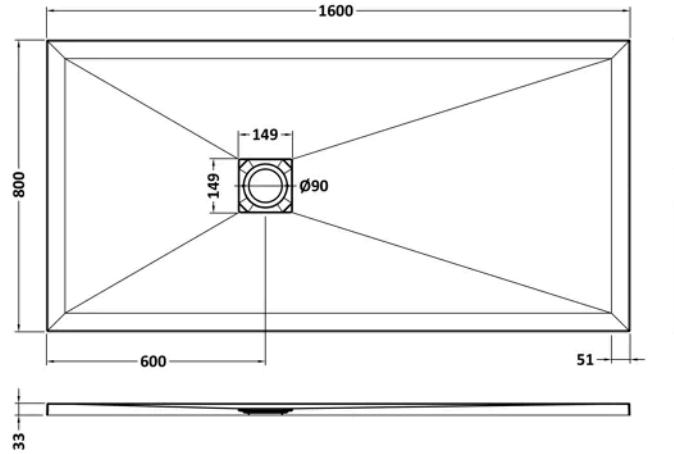

Product Dimensions

Product	32 x 800 x 1600mm (H x W x L)
Packaged	73 x 840 x 1640mm (H x W x D)
Nett Weight	57.9 kg
Packaged Weight	58.2 kg

Product Details

Country of Origin	United Kingdom
Product Material	Acrylic Capped Abs Caco3 And Pu
Colour/Finish	White Slate
Style	Contemporary
Ce Certified	Yes
Leg Set Included	No
Legs Included	No
Slip Resistant	No
Waste Included	No
Waste Shape	Square
Waste Size Required	90mm