

Sales Code: NLT71064

Barcode: 5056462656472

Brand: nuie

Description: 1700 x 900mm Grey Slate Rectangular Slimline Slimline Shower Tray

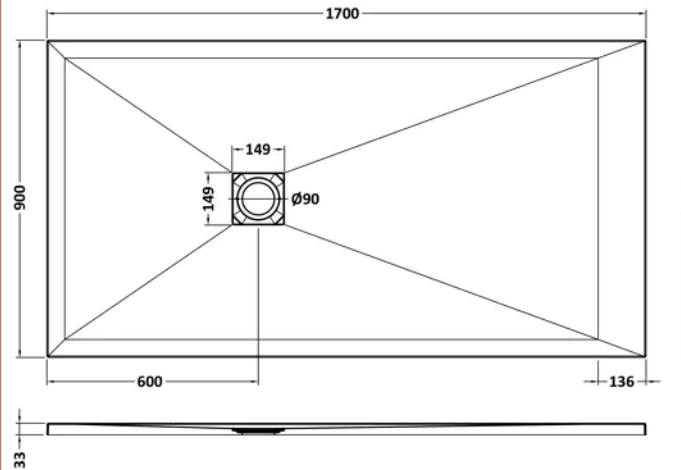

Product Dimensions

Product	32 x 900 x 1700mm (H x W x L)
Packaged	73 x 940 x 1740mm (H x W x D)
Nett Weight	70.2 kg
Packaged Weight	70.5 kg

Product Details

Country of Origin	United Kingdom
Product Material	Acrylic Capped Abs Caco3 And Pu
Colour/Finish	Grey Slate
Style	Contemporary
Ce Certified	Yes
Leg Set Included	No
Legs Included	No
Slip Resistant	No
Waste Included	No
Waste Shape	Square
Waste Size Required	90mm