

NOVOSOLID

NOVOSOLID is much more than a range of products: it's a new philosophy of thinking the bathroom space.

NOVOSOLID allows us to adapt the shower tray to any situation.



Natural stone texture effect in white or slate black

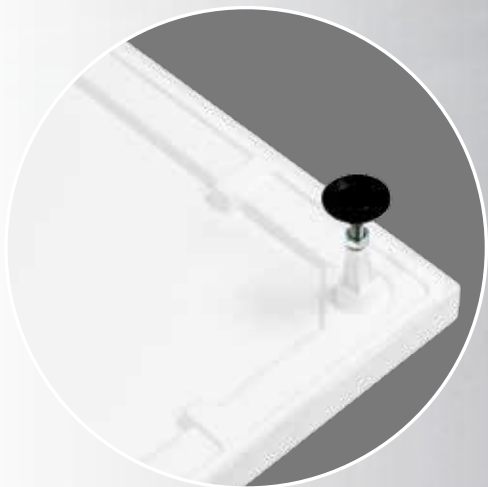

Moulding with ribs for an increases assurance of stability



SHOWER TRAYS

NOVOSOLID

TRAY HEIGHT 3.5CM
(HEIGHT WITH LEGS UP TO 14.5 CM)

Dimensions (cm)	Weight (Kg)	Code	Colour choice
Actual size A x B -2 / +3 mm			<div style="display: flex; justify-content: space-around;"> <div style="border: 1px solid black; border-radius: 50%; width: 20px; height: 20px; display: flex; align-items: center; justify-content: center;">30</div> <div style="border: 1px solid black; border-radius: 50%; width: 20px; height: 20px; display: flex; align-items: center; justify-content: center;">28</div> </div>
			<div style="display: flex; justify-content: space-around;"> Matt White Matt Black </div>
80 x 80	30	NOS804-	
90 x 90	36	NOS904-	
100 x 100	43	NOS1004-	
100 x 80	36	NOS100804-	
120 x 70	38	NOS120704-	
120 x 80	42	NOS120804-	
120 x 90	46	NOS120904-	
140 x 70	44	NOS140704-	
140 x 80	48	NOS140804-	
140 x 90	53	NOS140904-	
150 x 70	46	NOS150704-	
150 x 80	52	NOS150804-	
160 x 70	49	NOS160704-	
160 x 80	55	NOS160804-	
160 x 90	59	NOS160904-	
170 x 70	49	NOS170704-	
170 x 80	58	NOS170804-	
180 x 80	61	NOS180804-	
180 x 90	64	NOS180904-	

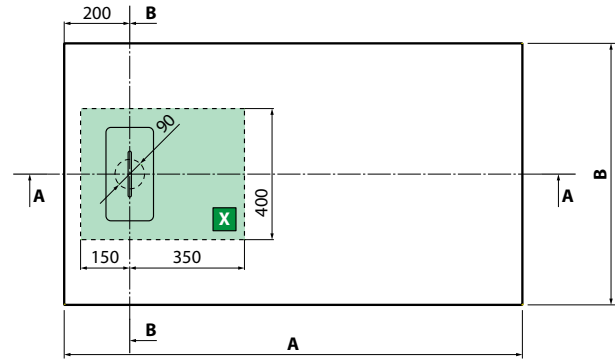

INSTALLATION STANDING ON FLOOR

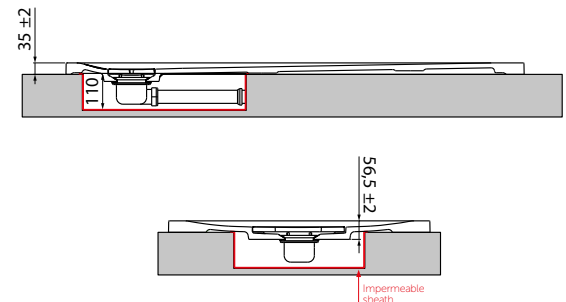

● IN STOCK UK

(Other products) please check availability

HIGH INSTALLATION WITH ADJUSTABLE FEET AND SIDE PANELS (CUTTABLE)

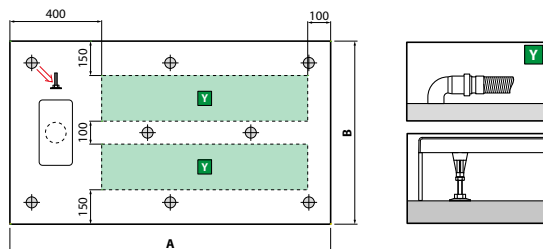
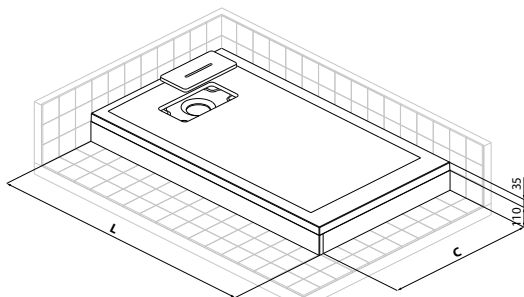

INSTALLATION FLUSH FLOOR

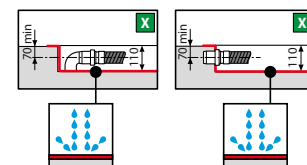
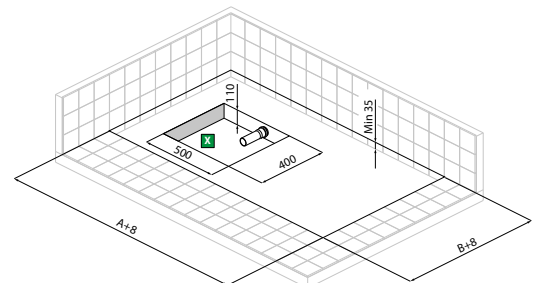

OPTIONAL

Waste column \varnothing 90 not included "with tray" Flow rate 27lt/min

Code

PIL90PCAB-CR40

REQUIRED

Compulsory

Imperial to Metric flex waste adaptor

Code

RISCCAB

For an perfect water tight use our drain **PIL90PCAB-CR40**, or waste columns with double lip seal.

Construction of the Code: Code + Glass + Profile = Final product Code

INSTALLATION FLUSH FLOOR



INSTALLATION STANDING ON FLOOR



HIGH INSTALLATION WITH ADJUSTABLE FEET AND SIDE PANELS



OPTIONAL

Easy Plumb kit

Panels can be cut to size (kit includes 2 Panels)
Height of panels 11cm - Height of tray with panels 14.5 cm

Size	Code	
	Matt White	Matt Black
90x100	PANPFLNS03-30	PANPFLNS03-28
90x150	PANPFLNS02-30	PANPFLNS02-28
90x180	PANPFLNS01-30	PANPFLNS01-28

REPAIR KIT



OPTIONAL

Repair kit made of:

two-component protective resin for customized cutting
+ Repair kit (customized pack)

Code	
Matt White	Matt Black
KITRNS-30	KITRNS-28

CUT

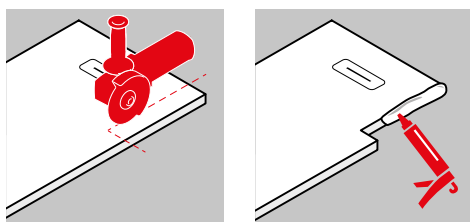

REPARATION

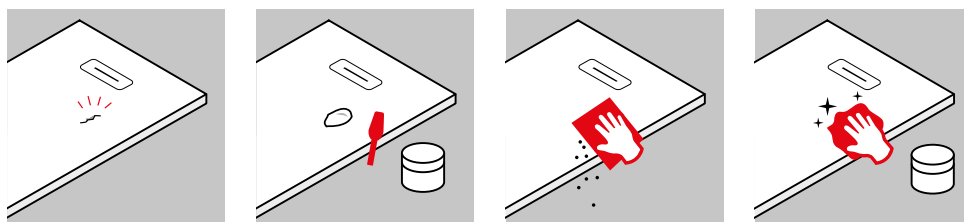

Novellini will honour the product's warranty assuming that the correct repair process has been followed using the correct Novellini repair kit

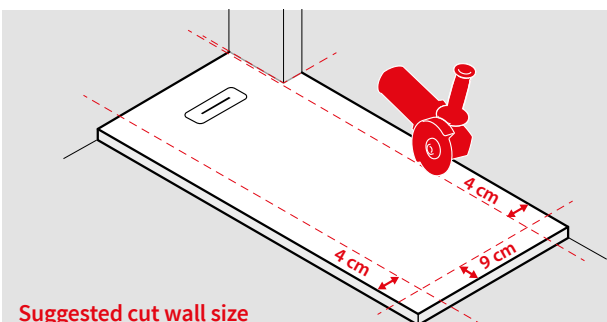

Suggested cut wall size

CUT TO SIZE

NOVOSOLID is much more than a range of products, it's a new philosophy of considering the space around you that allows you to adapt the shower tray to different situations with the ability to adjust it up to 9 cm on the long side and 4 cm on the short side.

TECHNICAL DRAWINGS - LOW PROFILE ACRYLIC CAPPED

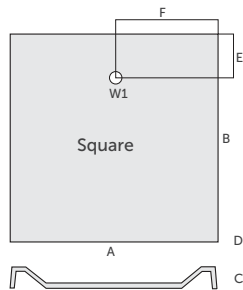

size mm	waste size	A	B	C	D	E	F
760 x 760	90	760	760	40	65	190	380
800 x 800	90	800	800	40	65	190	400
900 x 900	90	900	900	40	65	190	450
1000 x 1000	90	1000	1000	40	65	190	500

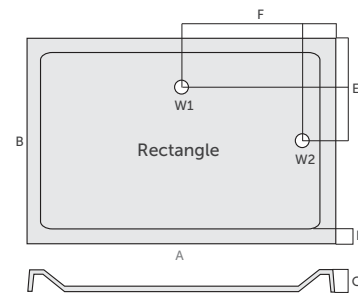

size mm	waste size	A	B	C	D	E	F
900 x 700	90	900	760	40	65	190	450
1000 x 800	90	1000	800	40	65	190	500
1100 x 800	90	1100	800	40	65	190	550
1200 x 800	90	1200	800	40	65	190	600
1200 x 900	90	1200	900	40	65	190	600
1400 x 900	90	1400	900	40	65	190	700

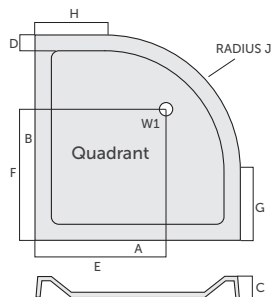

size mm	waste size	A	B	C	D	E	F	G	H	J
800 x 800	90	800	800	40	65	500	500	250	250	550
900 x 900	90	900	900	40	65	600	600	350	350	550
1000 x 1000	90	1000	1000	40	65	700	700	450	450	550

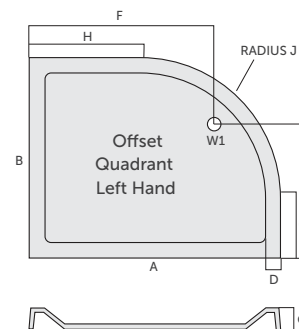

size mm	waste size	A	B	C	D	E	F	G	H	J
900 x 800	90	900	800	40	65	510	600	250	350	550
1000 x 800	90	1000	800	40	65	510	700	250	450	550
1000 x 900	90	1000	900	40	65	610	700	350	450	550
1200 x 800	90	1200	800	40	65	510	900	250	650	550
1200 x 900	90	1200	900	40	65	610	900	350	650	550

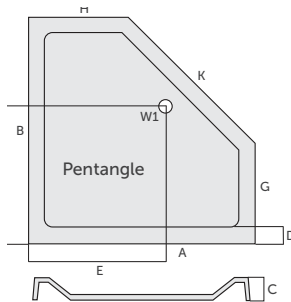

size mm	waste size	A	B	C	D	E	F	G	H	K
900 x 900	STD	900	900	95	60	510	510	400	400	700
1000 x 1000	STD	1000	1000	110	60	610	610	470	470	750

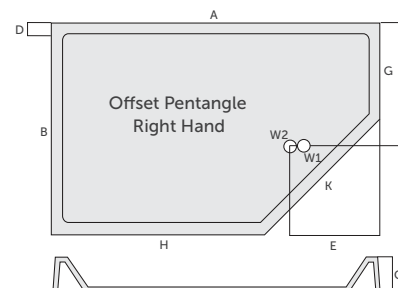

size mm	waste position	waste size	A	B	C	D	E	F	G	H	K
1200 x 900	W2	STD	1200	900	80	60	380	525	400	700	700
1400 x 1000	W1	STD TWIN	1400	900	110	60	385	520	400	900	700

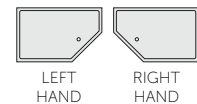

SHOWER TRAYS

TECHNICAL DRAWINGS - STANDARD HEIGHT STONE

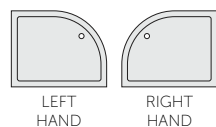
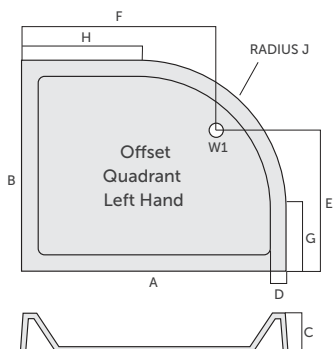

size mm	A	B	C	D	E	F	G	H	J
900 x 750	900	750	110	40	510	650	292	442	458
900 x 750	1000	750	110	40	510	650	292	442	458