

RAK - Petit Square

Double Towel Rail | 600

RAK
CERAMICS

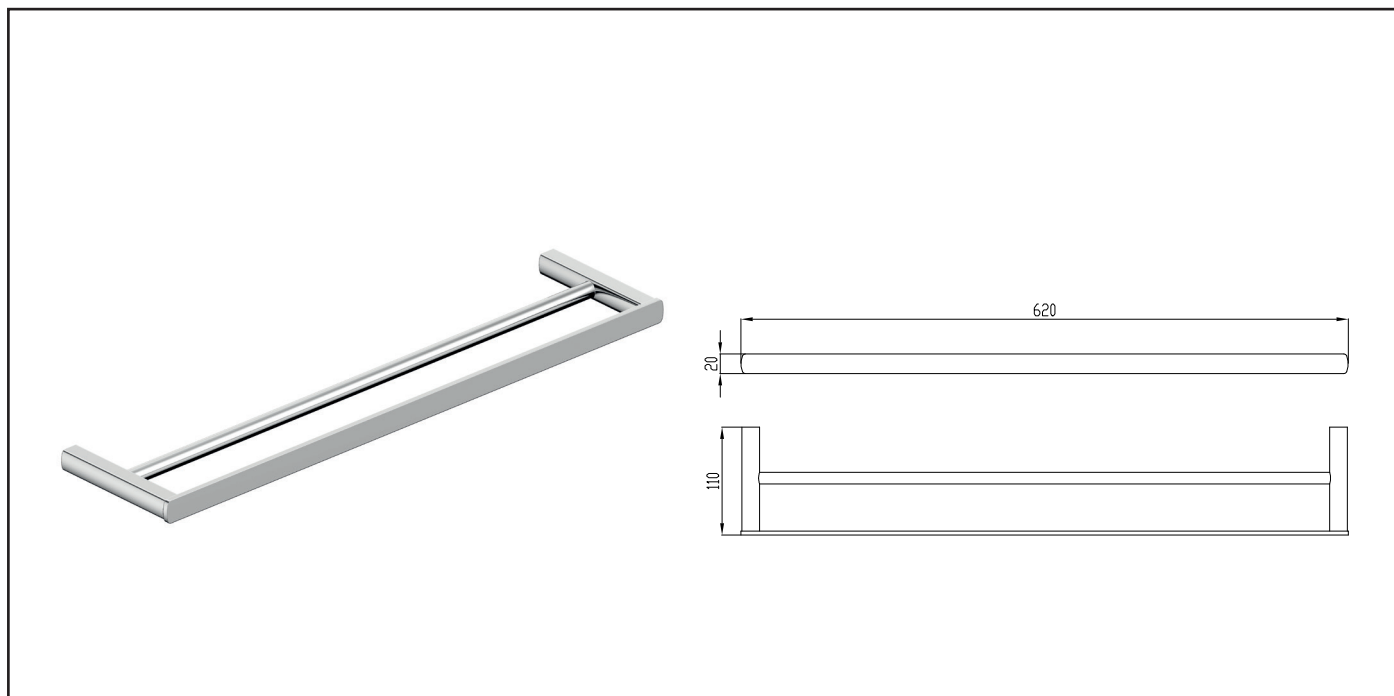

Dimensions:	620w x 110d x 20h
Colour:	Chrome (C), Nickel (N), Black (B) and Gold (G)
Code:	RAKPES9912-60X
Warranty:	15 Years
Weight:	0.9 kg

Dimension: All Dimensions in mm tolerance $\pm 5\%$ for below 200mm and $\pm 3\%$ for above 200mm.

Note: Due to a continuing development programme to improve design and performance the manufacturer reserves all rights to vary specifications without prior information.

Please note all accessories are for photographic use only.