

USER MANUAL

Please read this manual before installing your product
and keep for future reference.

Product name – Rossini Furniture

Product code – ROSS005

Dimensions
(measurements in mm)

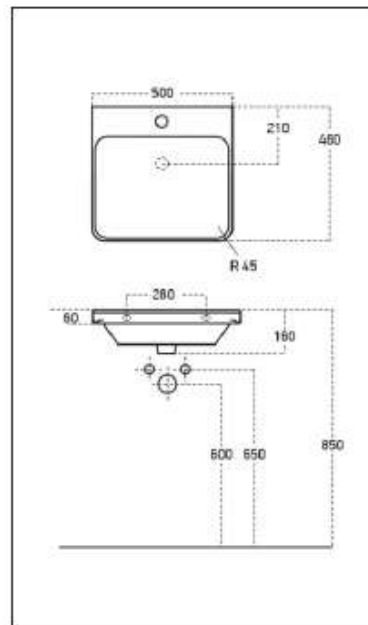
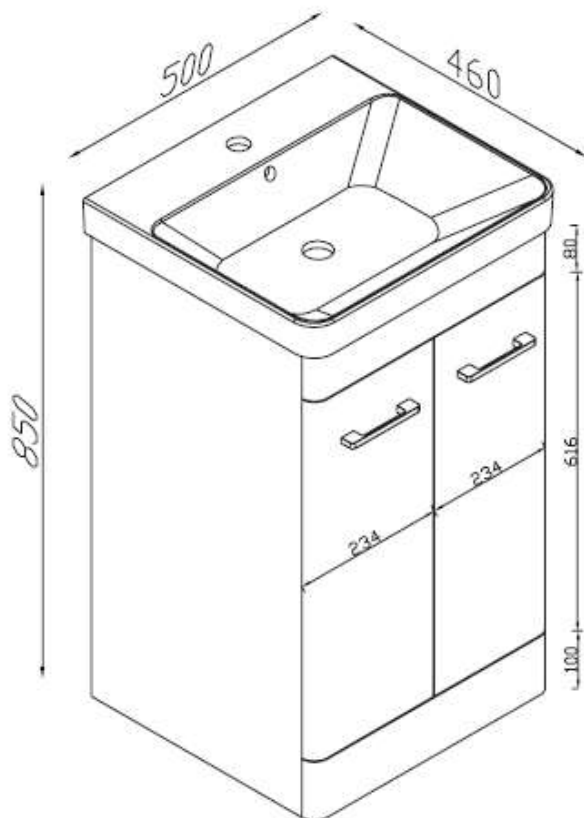

- **Single-person assembly**
- **We always recommend using professional tradespeople to install your product**

V1_26.10.2020

Important information

- Please read these instructions thoroughly and retain for future reference
- Should any of your items have a defect, please do not install as returns will not be accepted once fitted.
- We advise that you use a qualified person to install your units, as any issues relating to poor fitting will not be accepted by the supplier.
- You have purchased the handmade and in some cases hand painted product. Therefore, you may see some slight imperfections with the supplier may deem as acceptable.
- This product is water resistant but NOT waterproof.
- Please avoid direct sunlight as this will cause the painted surfaces to discolour.
- Due to motion in transit, the cabinet doors and drawers may need to be adjusted after installation
- Floor standing units must be fitted back to the wall through the back rail using suitable fixings. (not supplied)
- Wall hung units must be secured back to the wall using the wall hanging brackets supplied. Additional support is recommended (not supplied)
- The hinge on the laundry bracket can be adjusted by slackening the screw on the side of the sliding bar.
- When fixing to a stud or panelled wall, appropriate framework should be installed to support the basins and units.
- Where units or worktops have been cut out for services, all raw edges MUST be sealed against water ingress.
- Under no circumstance should water be allowed to stand on any wood-based product, ensure any spillage is removed as soon as possible

Tools required

- Masonry drill
- Masonry drill bit (to suit wall plug)
- Chuck drill
- Wood drill bit (not larger than screw head)
- Masonry drill bit
- Silicone
- Silicone gun
- Wall plugs (not supplied)
- Screws (not supplied)
- Tape measure
- Spirit level

Furniture installation

- Remove from packaging visually inspect for defects (report any defects to retailer prior to installation)
- Pre-drill mounting plinth approx. 150mm from the inside edge

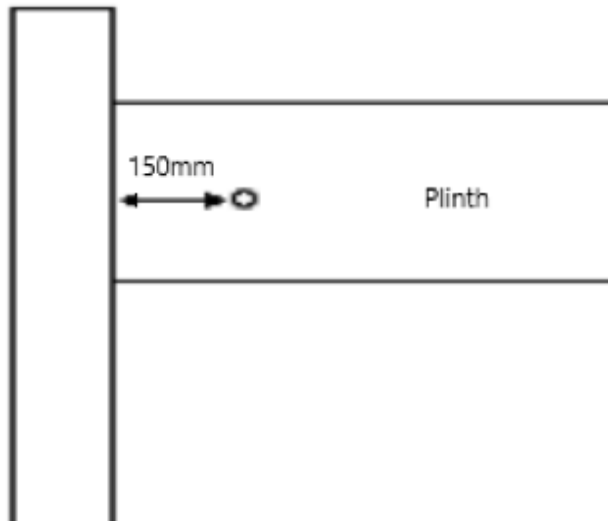

- Place unit in required location
- Level all four planes
- Mark wall for drilling
- Remove unit, drill as required install wall plugs
- Replace unit and secure to the wall

Basin installation

- Remove from packaging visually inspect for defects (report any defects to retailer prior to installation)
- Install tap and waste as per manufacturing instructions
- Place a bead of silicone on the unit (as shown below)

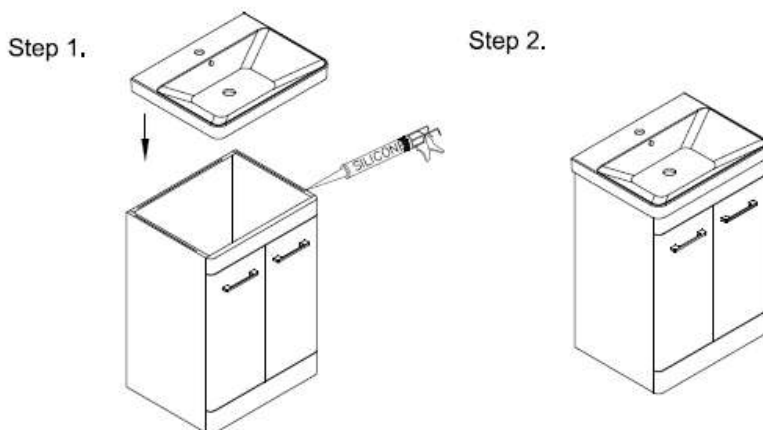

- Ensure the basin is level on all four planes, failing to do so will affect basin function and will invalidate warranty

Maintenance

Please note that although these units have been designed to give years of pleasure and satisfaction, you will help maintain the original beauty of your bathroom by following these guidelines.

Melamine, vinyl and foil wrapped doors

Occasional marks, can in most cases, be removed with a soft damp cloth. More persistent marks can be removed using a non-silicone-based furniture cleaner. Hot soapy water should be avoided. Once the mark is removed, the area should be wiped over with a damp cloth to remove any excess and dried with a soft clean cloth. On no account should solvent or an abrasive cleaner be used as permanent damage to the finish could take place.

High Gloss Doors

Use a cleaning product not containing aggressive substances like acetone, alcohol, bleach etc. as those components could seriously damage the surface of the door. The best would be to use a soft cotton or micro fiber cloth with only water and a soft soap (containing a maximum 1% of liquid soap)

Carcass components

Do not use polish on any surfaces. A damp cloth with soapy water will clean off most marks or spills. On no account should any spillage, even water, be allowed to lie on the surface. Bleaches scouring pads and multi-surface cleaners should not be used.

Drawers, runners, door hinges.

These should be wiped out with a damp soapy cloth and wiped dry with a soft cloth as necessary. The roller runners and hinges are lubricated and should not be cleaned with a degreasing agent as this will affect the action of the moving parts. Never lean on partially or fully opened doors and drawers in order to gain access to the units. The hinges are specified to adequately support the weight of the door, plus small additional weights such as wire accessories. It is advised that once the bathroom has been installed, you should check every six months that all screws on the hinges are tight.

Worktops

Although the worktop is hard wearing, sharp objects will scratch and excessive heat will scorch the surface. Care should be taken not to drop any heavy objects onto the worktop as the surface may crack. For cleaning, a damp soapy cloth will clean off most spills. Bleaches, scouring pads and multi-surface cleaners should not be used. Corrosive liquids and make-up should be wiped off immediately. On no account should any spillage, even water, be allowed to lie on the surface.

Temperature, humidity, ventilation and proximity

Avoid excessive change in temperature and humidity. We would advise an extractor fan to be installed in all bathrooms which include furniture to reduce the chance of water ingress damage. The extractor fan should be used every time that the shower/bath is used and should be left switched on for a sufficient time afterward to allow for adequate ventilation. Ensure that the fan has been correctly sized for the room in use. The units, under no circumstance, should be fitted in a location where they are regularly subjected to contact with water.

Regulations

If it is your intention to remove and replace your bathroom fittings with 'like for like' units, then this is classed as 'non regulated' and no building regulations would be required. However, building regulation approval may be required if the bathroom refurbishment involves altering the drainage or the internal layout within the dwelling to accommodate the new fitting such as a second bathroom. In this instance, we would advise you contact the building control department at your local authority to discuss the need for a formal building regulation application

Macerator – current building regulations specify that a Sani pump smallbore system can be fitted in a dwelling where there is also a normal gravity discharge W.C. it should not be the only W.C. facility.

Electrical – remember that double pole isolating switches are required for all electrical points apart from special razor sockets. All work must conform to BS7671:2008 the current I.E.E regulations

Hinge Adjustment

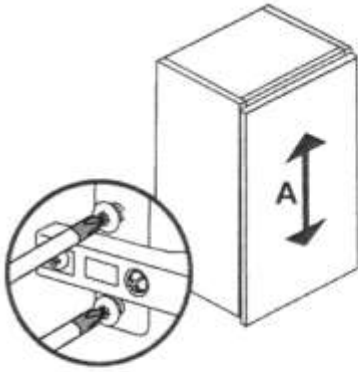

A-VERTICAL
Loosen screw 'A' on all hinges.
Adjust door and re-tighten screw.

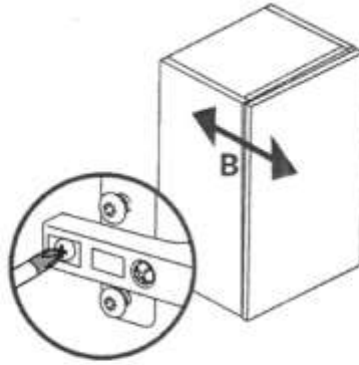

B-LATERAL
Loosen screw 'B'.
Adjust door and re-tighten screw.

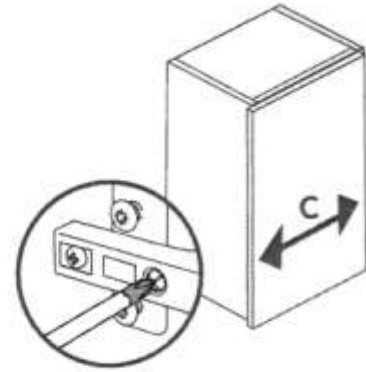

C-HORIZONTAL
Loosen screw 'B' ½ turn.
Turn screw 'C' until door
is positioned correctly and
re-tighten screw 'B'.

Cleaning

To maintain the surface of your product, wipe with a clean damp cloth and wipe dry, do not use any abrasive cleaning agents or materials. If any harsh chemicals come into contact with the surface of the product, rinse and wipe clean immediately