

Installation Instructions

Rectangle Shower Tray

1500 x 900mm x 40

S0023



Before you Start



Please read these instructions fully before starting. Although these instructions are comprehensive we always recommend that a technically competent installer undertake the installation.

Unpack and check that the shower tray is the colour, size, shape and type you require. Check for any damage. **Do not install if not satisfied and contact your local supplier.**

Check that the top surface of the shower tray is compatible with your intended shower enclosure, taking into account the loss of dimension that will result after tiles etc have been fitted.

When considering your installation method, you should be able to attach or repair your waste or waste outlet in-situ.



Important

For raised installation, please use a Panel Riser Kit applicable to the size and shape of your chosen shower tray.

If you install this shower tray in conjunction with a steam unit, you must ensure the steam outlet is at a minimum of 350mm from the top of the tray.



When handling your shower tray take care not to damage the bottom edges and when installing take particular care to protect the visible surfaces from impact damage or abrasions.



Safety Notes

Caution: Care must be taken when drilling into walls or floors to avoid hidden pipes or electrical cables.

This product is heavy and requires a 2-person lift.



Care & Use of Your Shower Tray

These installation instructions should be retained and passed to the user for possible future reference.

Your shower tray can be maintained in an as near new condition for many years by following a simple cleaning procedure as follows:

It is normal for small amounts of localized water to be retained on the shower tray surfaces after use which should be wiped dry immediately to prevent build up of sediments.

The shower tray should be cleaned regularly with warm, soapy water only and dried with a cloth. Never use scourers, abrasives, bleach or other chemical cleaners.



Technical Help

Technical Service Line: 0330 124 7290



Dimensions are nominal and shown in millimetres unless otherwise stated.

Parts Supplied

- A** Shower Tray (Shape and style of tray may differ from that illustrated)

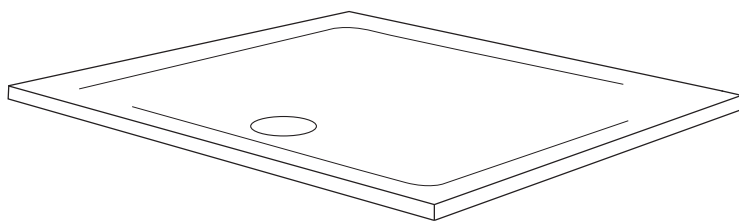

Qty 1

Tools and Materials Required (not supplied)

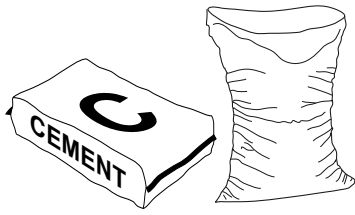

Cement and Fine Sand



Anti-Crumbling Cement Additive

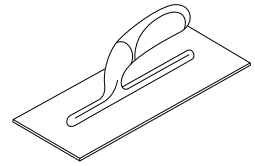

Trowel

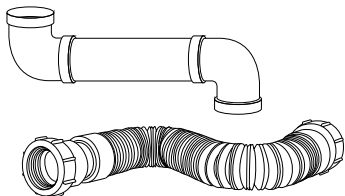

Plumbing Pipe and Fittings

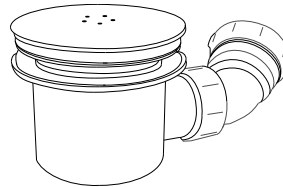

Waste Unit

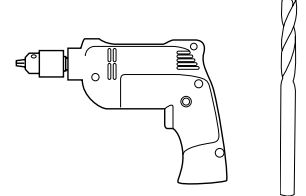

Power Drill and Drill Bits



Spirit Level

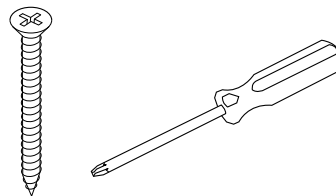

Floor Screws and Screwdriver



Safety Eyewear

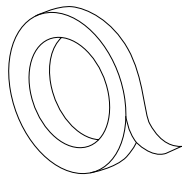

Masking Tape

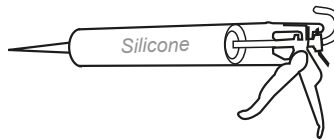

Silicone Sealant

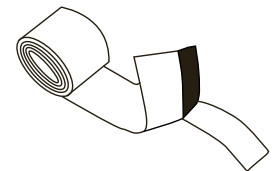

Flexi Seal Strip



Plywood Board (min 18mm thick)



Jigsaw

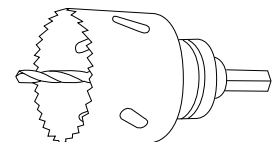

Hole Cutter



Pencil

Note! Other tools and materials may be needed depending on the specific site requirements.

Installation – Solid Floor

1

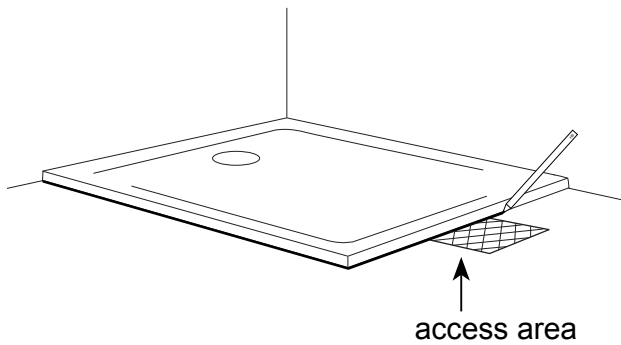

Place the shower tray **A** in position on the floor (ensuring surface is level) and mark the perimeter and waste hole on the floor including an area outside the perimeter for access to connect plumbing (as dictated by the installation location) after the shower tray has been installed.

If using a shower tray with a built in tiling upstand, allowance must be made for recessing the tray into adjacent walls to allow tiling down onto the tray surface.

2

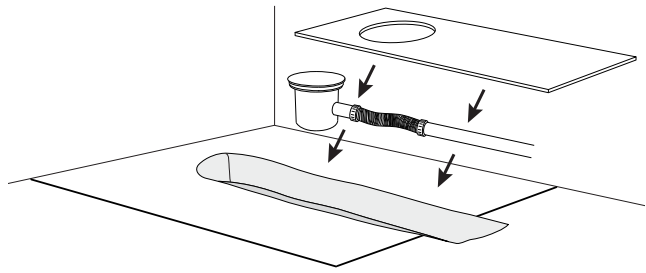

Form a trench in the floor to hold the waste unit and piping.

Before proceeding, dry fit all items in-situ to ensure compatibility.

Install the waste unit and piping in the trench in accordance with building regulations, protecting any exposed threads with masking tape.

If necessary, blank off the trench using 18mm ply with waste outlet hole, ensuring that the plumbing connections can be made once the shower tray is in position.

3

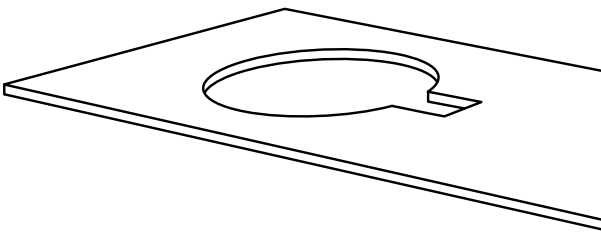

Note! With some types of waste unit, it may be necessary to form a keyhole shaped cut-out in the ply using a jigsaw. This will make access to the waste unit easier.

4 **Optional Flexi Seal Strip**

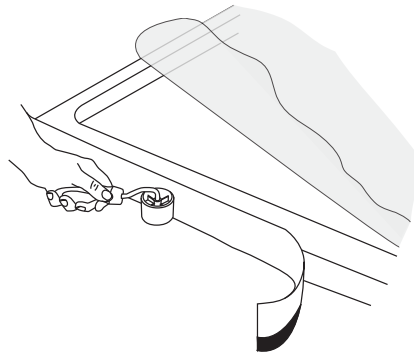

Note! Some shower trays have a protective film (indicated by a label on the surface) which **MUST** now be removed. Undertake a final inspection of the shower tray at this stage. **DO NOT PROCEED IF NOT SATISFIED.**

We recommend the use of the optional Flexi Seal Strip (not supplied). If fitting, follow the instructions later in this guide to attach the strip to the shower tray at this stage.

Floor Level Installation for Concrete or Other Solid Floors

Installation – **Solid Floor**

5



Mix fine sand, cement and a cement additive in accordance with the manufacturers instructions to a workable mix to cover the total area under the tray. Trowel to a thickness suitable to allow leveling and full support of the shower tray.

Note! Silicone sealants, foams, mastics, installation compound adhesive or similar MUST NOT be used as a substitute for cement.

6

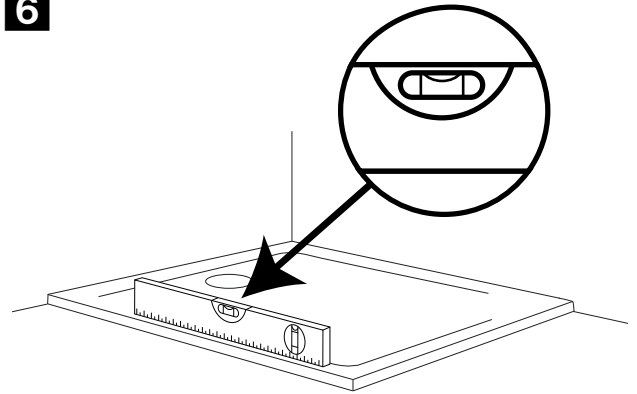

Place shower tray **A** onto the wet cement ensuring that it is fully supported. Check the level of the top rims only as the shower tray has built-in fall for adequate drainage.

Remove any excess cement and allow to set fully before continuing.

7

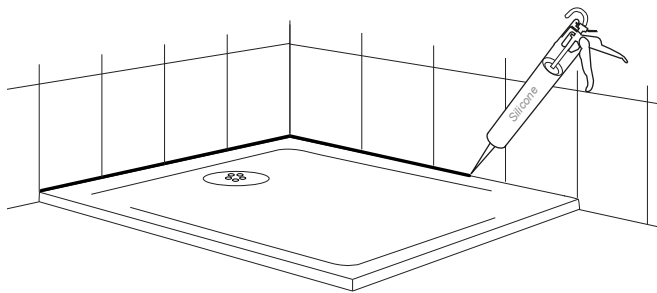

When the cement has set, make connection between the shower tray and waste piping. The shower tray and all connections **MUST** now be checked for water tightness, flow and adequate drainage over the entire area.

DO NOT PROCEED IF NOT SATISFIED.

After all checks and adjustments, tile and then seal along the tiling line with silicone sealant.

8

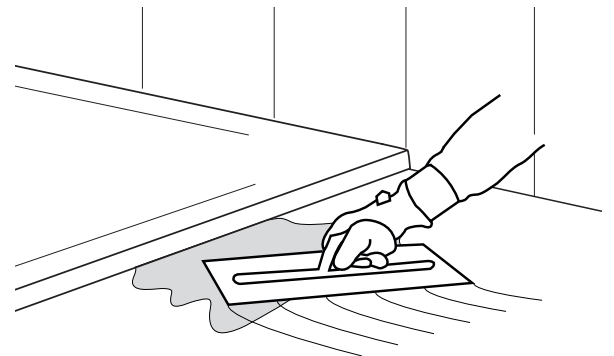

Fill in the access area and the waste pipe trench beneath the shower tray **A** with cement to give full support to the shower tray when in service.

If fitting a shower enclosure refer to the manufacturers installation instructions.

Installation – *Suspended Floor*

1



Place the shower tray **A** in position on the floor (ensuring surface is level) and mark the perimeter on the floor including an area outside the perimeter for access to connect plumbing (as dictated by the installation location) after the shower tray has been installed.

If using a shower tray with a built in tiling upstand allowance must be made for recessing the tray into adjacent walls to allow tiling down onto the tray surface

2

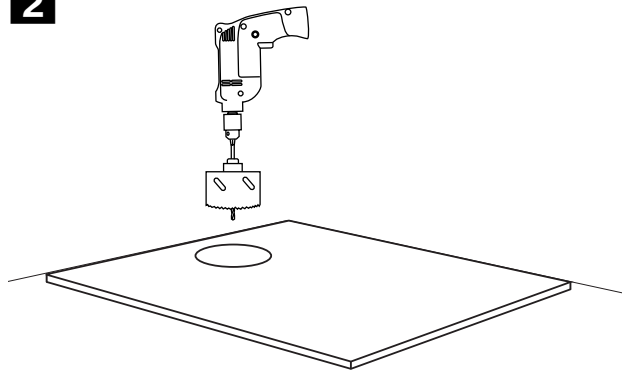

The floor area (or larger) covered by the shower tray must be removed and replaced with a single level piece of plywood (minimum 18mm thick).

Put the plywood in position, ensuring the area is flat and level. Place the shower tray **A** on the plywood and mark the waste hole location.

Remove the shower tray then use the hole cutter to drill a hole in the plywood large enough to pass through the entire waste unit. Keep all holes to the minimum.

3

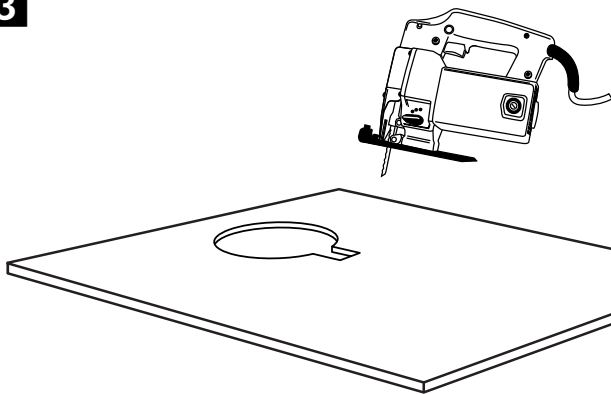

Note! With some types of waste unit, it may be necessary to form a keyhole shaped cut-out in the ply using a jigsaw. This will make access to the waste unit easier.

4

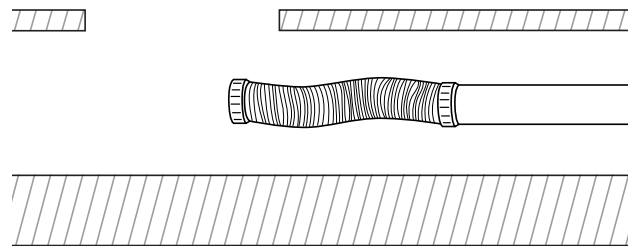

Remove the plywood and install the waste outlet pipe in the cavity in accordance with building regulations.

5 Optional Flexi Seal Strip



Note! Some shower trays have a protective film (indicated by a label on the surface) which must now be removed. Undertake a final inspection of the shower tray at this stage. DO NOT PROCEED IF NOT SATISFIED.

We recommend the use of the optional Flexi Seal Strip (not supplied). If fitting, follow the instructions later in this guide to attach the strip to the shower tray at this stage.

6

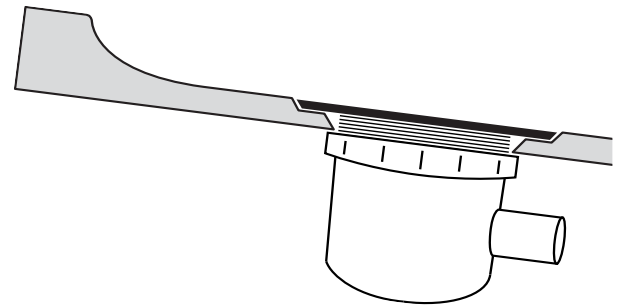

Fit the waste unit to the shower tray following the instructions supplied with the unit and protect exposed threads with masking tape. Before proceeding dry fit all items in-situ to ensure compatibility and then screw the plywood level into position.

7

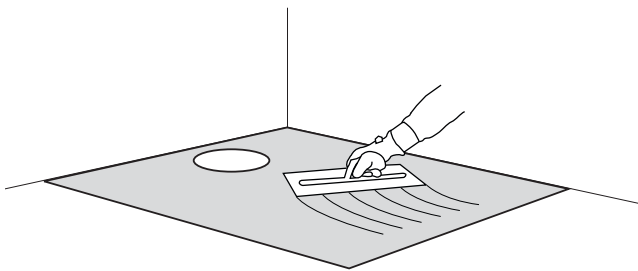

Mix fine sand, cement and a cement additive in accordance with the manufacturers instructions to a workable mix to cover the total area under the tray. Trowel to a thickness suitable to allow leveling and full support of the shower tray.

Note! Silicone sealants, foams, mastics, installation compound adhesive or similar MUST NOT be used as a substitute for cement.

8

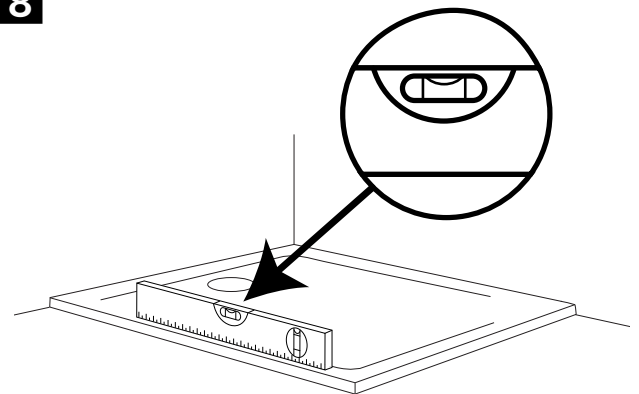

Place shower tray **A** onto the wet cement ensuring that it is fully supported. Check the level of the top rims only as the shower tray has built-in fall for adequate drainage.

Remove any excess cement and allow to set fully before continuing.

Installation – *Suspended Floor*

9

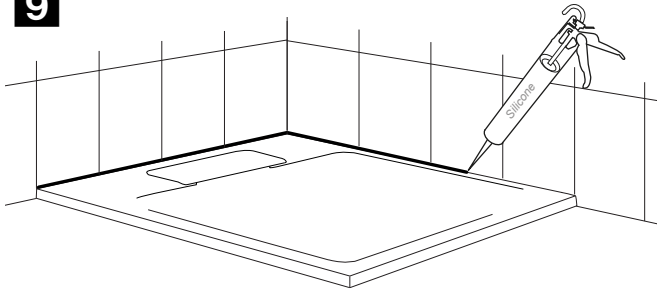

Fit waste cover **B**. The shower tray and all connections **MUST** now be checked for water tightness, flow and adequate drainage over the entire area with the waste cover **B** in position.

DO NOT PROCEED IF NOT SATISFIED.

After all checks and adjustments, tile and then seal along the tiling line with silicone sealant.

If fitting a shower enclosure refer to the manufacturers installation instructions.

Troubleshooting



Q The waste outlet in the shower tray is directly over an obstruction at floor level.

A Consider switching to a Panel Riser Kit, or re-locating the shower tray.

Q The shower tray will not fit the space available.

A Consider recessing the edge of the tray into adjoining walls or using a smaller shower tray and enclosure.

Q There is water retaining on the surfaces of the tray.

A Check that the shower tray is level (top rims) as it is normal for small amounts of localized water to be retained.

Q Water will not flow fast enough down the waste outlet.

A Check that the waste unit is correctly installed and that outlet pipe has sufficient angle and is not kinked or sagging causing an air blockage.

Q The enclosure will not fit on the shower tray.

A Check that the available surface on top of the tray is compatible with the size, shape and adjustment range of your enclosure.

Q Water escapes from a fitted walk-in or frameless enclosure.

A It is normal for spillage to occur from walk-in or frameless type enclosures, consider fitting a threshold seal on or changing to a fully framed enclosure.

Q Could I have a carpet on the floor in the bathroom?

A It is advised that you use only safety vinyl or tiled flooring in the bathroom area.

Flexi Seal Strip

(not supplied with shower tray)

This product is intended as a flexible tiling upstand and should be fitted to the side of the tray adjacent the walls only.

Tools and Materials Required (not supplied)



Scissors

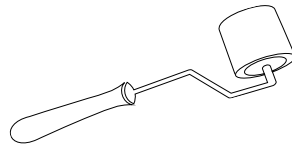

Small Roller



Silicone Sealant



Damp Cloth

Installation – Flexi Seal Strip

1



Wipe the surfaces clean where the strip will be attached first with a clean damp cloth, allow to dry and then wipe with the IPA wipe supplied in the kit.

Determine the length of strip required to seal around the shower tray and cut to length with scissors. (Ensure you cut at least 20mm longer than needed).

Peel back approximately 20cm of backing from the adhesive strip.

2

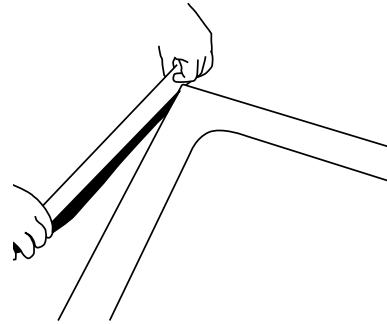

Attach to the edge of the shower tray so that it is square and the edge protrudes at least 20mm above the edge of the tray.

Make sure the adhesive strip is positioned so that it will not come into contact with any silicone sealer used later.

3



Using a small roller or other appropriate tool roll the seal strip so that it attaches firmly to the edge of the tray removing any bubbles or creases, paying particular attention to the corners.

Gradually remove the cover strip in sections and roll on the seal so it attaches firmly and square to the edge of the tray, making sure there are no gaps between tray and seal strip. Trim off any excess strip.

4



Install the shower tray in the correct position and tile in front of the seal strip.

Put a protective bead of silicone or other suitable flexible sealant between the tray and the tile, ensuring it does not come into contact with the adhesive material on the flexi seal strip.