

SM 3/4 C

SMILE Tap Range Smile Bath Taps Chrome



Features:

- Long life and easy to use 1/4 turn ceramic disc valves
- Metal back nuts for added durability.

Specify As

Bristan "SM 3/4 C" Smile Basin Taps with loop handles, 3/4" BSP threaded inlet tails and 1/4 turn ceramic disc valves. Product is WRAS Approved with a 5 year warranty. Manufacturer: Bristan Group Limited. Contact Details: contractenquiry@bristan.com

Product Certifications:



WRAS Cert. Number: 2104904
WRAS Expiry Date: 30/04/2026

For more products, visit our website:
<http://www.bristan.com>



Specification

Product Type:	Bathroom Taps
Main Construction Material:	Brass
Mount Type:	Deck Mounted
Handle Type:	Lever Handles
Connection Inlet:	3/4" BSP
Connection Outlet:	M20 Flow Straightener
Number of Tap Holes:	2
Valve/Cartridge Type:	3/4" Ceramic Disc Valve - 1/4 turn
Plumbing System Requirements:	Suitable for all plumbing systems
Minimum Dynamic Pressure (bar):	0.2 bar
Maximum Dynamic Pressure (bar):	5.0 bar
Maximum Hot Water Temperature °C:	65°C
Maximum Static Pressure (bar):	10 bar
Isolation Included:	No

Dimensions (measurements in mm)

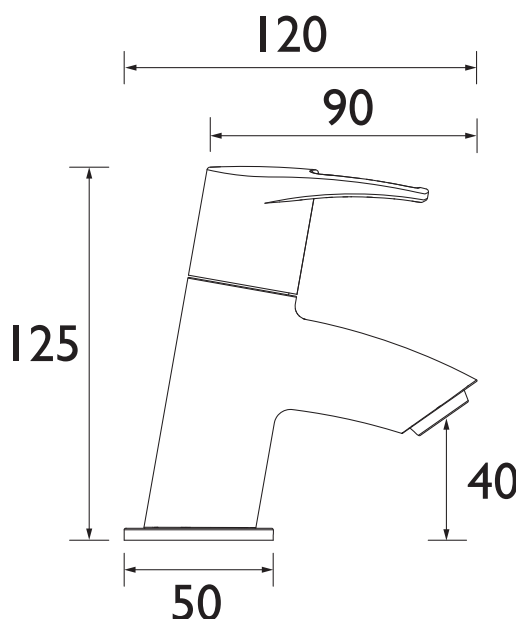

Flow Rates (l/min)

System Pressure (bar)	0.2	0.5	1	2	3	5
SM 3/4 C (Cold)	9.9	25.3	36.2	51.1	61.9	103.2
SM 3/4 C (Hot)	9.9	25.3	36.2	51.1	61.9	103.2

TECHNICAL DATA SHEET



BRISTAN

D6