

Sales Code: SOA328

Description: Soar W/M Single Lever Basin Mixer

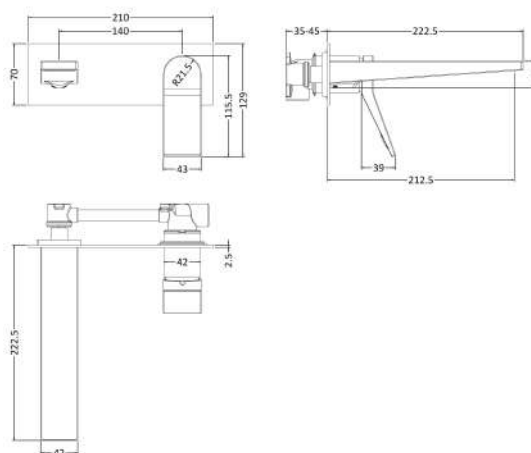

### Product Dimensions

Height (mm):	129
Width (mm):	210
Depth (mm):	223
Length (mm):	
Nett Weight (kg):	1.8

### Packaging Dimensions

Height (mm):	93
Width (mm):	170
Depth (mm):	268
Gross Weight (kg):	2

### Packaging Data

Box Colour:	White Cardboard Box
Box Qty:	0
Label Size:	0 x 0
Label Colour:	White Label
Label Qty:	0

### Outer Box Dimensions (If Applicable)

Height (mm):	
Width (mm):	
Depth (mm):	
Length (mm):	
Gross Weight (kg):	
Barcode:	5056211840237

### Product Details

Country of Origin:	China
Fitting Instruction:	Yes
Product Material:	Brass
Control Type:	Manual
Waste Included:	Waste Not Included
Waste Type:	Not Applicable
WRAS Approval: No	Approval No:
Valve/Cartridge Type:	Single Lever Cartridge
Colour/Finish:	Chrome
Mount Type:	Wall
Operating Pressure (bar):	0.5
Flow Rates: (Litres Per Min)	0.1 bar: 2.5   0.5 bar: 8   1 bar: 12   2 bar: 17   3 bar: 21
Pipe Size:	1/2"
Pipe Centres:	N/A