

Technical Data Sheet

Thermostatic Concealed Valves

ROPER RHODES®

No.	Description	Code	Fixings Included
1	Thermostatic Single Function Valve	SV3513	YES



Flow from valve may vary depending on accessories and domestic supply.

Inlet Pressure	Flow Rate (l/min)
0.1bar	7.43
0.2bar	10.50
0.3bar	12.87
0.4bar	14.86
0.5bar	16.61
1bar	23.50
2bar	33.23

Dimensions - SV3513

Diagrams not to scale. All dimensions in mm (tolerance of +/-5mm)

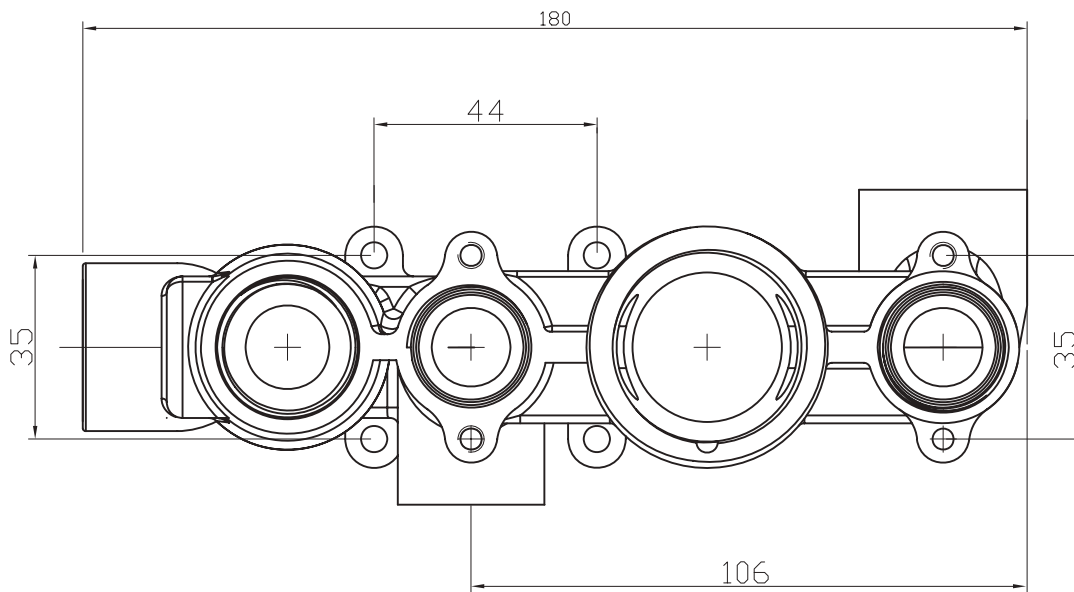

*Dimensions are subject to change, customers are advised to measure actual product before commencing installation.

FAQs

What is included in the valve box? The valve, a cover plate, a set of handles and trim rings.

How many fixing holes does the valve have? Four - two on the bottom and two on top of the valve.

What is the size of the connections? The valve uses 3/4" connections.