

**Salamander Pumps** 

# Pump installation and warranty guide for the CT range of pumps

CT Force, CT Xtra, and CT Bathroom



This document should be given to the end user and retained for future reference. Should you need to contact Salamander Pumps you will need the below information.



Models shown:  
CT FORCE 15TU  
CT50+ Xtra

**MADE IN  
BRITAIN** 



ISSUE L  
Oct 2021

# Pump installation and warranty guide for the CT range of pumps

## Important - read this first!

Correct installation is the guarantee of safety and a trouble free system. It is therefore important to read these instructions *thoroughly* and ensure you comply with them. Incorrect fitting will invalidate the warranty.

If your installation is complicated or you have any questions please CONSULT THE PUMPWISE TECHNICAL HELPLINE IMMEDIATELY on 0191 516 2002 (01844-3212 ROI).

We encourage installers to consult the PumpWise helpline, where our representatives can give you first-rate advice regarding installation

DO NOT REMOVE YOUR PUMP FROM THE SYSTEM WITHOUT FIRST RINGING PUMPWISE ON 0191 516 2002 (01844-3212 ROI).

Please leave this instruction booklet with the customer for reference to maintenance, safety information and details of warranty cover.

Thank you for choosing Salamander Pumps.

## Safety in Operation

These appliances are not for use by persons (including children) with reduced physical, sensory, or mental capabilities, or lack of experience or knowledge, unless they have been given supervision or instruction concerning the use of the appliance by a person responsible for their safety.

Children should be supervised to ensure that they do not play with the appliance.



Scan QR to find out more about  
avoiding some common pitfalls

---

# Contents

**CT FORCE range of pumps**  
**CT Xtra range of pumps**  
**CT Bathroom range of pumps**

<b>Product description</b>	<b>4</b>
<b>Installation instructions</b>	<b>4</b>
Step 1: Pump location	6
Step 2: Connecting the pump	10
Step 3: Electrical installation	11
<b>PumpWise Guidelines</b>	<b>12</b>
<b>General specifications</b>	<b>17</b>
<b>Technical specifications</b>	<b>19</b>
<b>Trouble shooting</b>	<b>22</b>
<b>Salamander PumpWise</b>	<b>23</b>
<b>Warranty</b>	<b>24</b>

# Pre-installation Checklist

Our installation guidelines are detailed on the following pages, but some of the key “do’s and don’ts” are highlighted below:

## Do’s

- Locate the pump next to the hot water cylinder or within 5m of measured pipe. 2m maximum of 15mm pipework on inlet connections may be used
- Allow 100mm on all sides for ventilation
- Ensure pump is protected from frost
- If servicing two or more bathrooms, cold water supply to the cylinder should ideally be in 28mm pipework to ensure adequate flow
- Ensure adequate usable cold water storage - 227 litres (50 gal) per bathroom, and 136 litres (30 gal) per en-suite or shower room.
- Cold water supplies to the pump must be taken from the opposite side of the cold water storage cistern to the cold water mains inlet
- Multiple cold water storage cisterns must be linked in accordance with current regulations and the bottom of the cisterns must be at the same level
- Hot water supply to the pump must be via a Salamander approved method
- Always use an Essex Flange or secondary return connection where there is less than 1m between the top of the hot water cylinder and base of the cold water cistern
- AV couplers must only be finger tight plus one quarter turn
- The maximum static head is 10 metres (equivalent to 1.0 bar pressure)
- The pump should be activated for at least 5 minutes every 4 weeks to ensure pump does not seize, by exercising all moving parts.
- Ensure that installation complies with IET wiring regulations
- All AV hoses should be fitted straight with no twists or bends
- Ensure suitable means of isolation for maintenance
- Bathroom Zones: Salamander products covered in these notes cannot be installed in Zone 0 or Zone 1. They can however be installed in areas that are accessible with a tool (see Step 1 Pump Location for further information (Fig 3)

# Pre-installation Checklist (continued)

## Don'ts

- Never fit the pump to the cold water mains
- Never fit the pump to shared incoming mains supplies to a block of flats
- Never use a shared water supply or shared, communal cold water storage cistern
- Never put a non-return valve (NRV), restrictive ballofix or an air vent on supply pipe work to the pump
- The hot water supply must not exceed temperature stated in the installation guide
- Never use mechanical tools to tighten plastic coupler nuts as this may cause damage and invalidate your warranty
- Never use jointing compounds, Boss White, Hemp or steel wool
- Solder fluxes must not come into contact with the pump or AV couplers (hoses)
- Never pump directly to or from any pump such as secondary return pump or a shower with integral pump.
- Never fit pump to a Fortic Cylinder, primatic cylinder, Elson Tank or Andrews type water heater (on rare occasions where a Fortic cylinder has adequate cold water storage, if all other fitting criteria can be met, this would be acceptable)
- If considering fitting pump to a Horizontal (torpedo) water cylinder then please contact PumpWise on 0191 516 2002
- It is not recommended to pump hot water against cold mains water with a positive head pump

# Product Description

Salamander pumps are suitable for pressure boosting vented stored water systems but please note that inlet pressures to the pump and water temperatures must not exceed values stated in the technical specifications.

## Installation instructions

Please follow these installation instructions carefully. Failure to install your pump in accordance with these instructions will invalidate your warranty. Any queries should be directed to PumpWise on 0191 516 2002 (01844-3212 ROI).

Do not use Salamander pumps for applications other than those stated within the pump description, or connect the pump directly to the cold mains.

To do so invalidates the warranty.

The plumbing installation must comply with "The Water Supply (Water Fittings) Regulations 1999", and all current regulations.

Please note that:



- CT Xtra 50, 50+, 54, 75, 75+ & 79 are shower specific pumps  
(Scan QR to find out more)
- CT FORCE 15 PT, 15 IPT, 20 PT, 20 IPT, 30 PT & 30 IPT, CT Bathroom 60B, 80B, and CT Xtra 64H, 69H & 84H are whole house pumps
- CT FORCE 15 TU, 15 ITU, 20 TU, 20 ITU, 20 SU, 20 ISU, 30 TU, 30 ITU, 30 SU & 30 ISU, CT Bathroom, 60BU & 80BU, and CT Xtra 64 HU, 69HU & 84HU are universal pumps.
- CT FORCE 20 PS, 20 IPS, 30 PS & 30 IPS, CT Xtra 55, 55+ & 59, 85, 85+, & 89 are positive single impeller pumps.
- Inlets and outlets must be vertical and plumbed appropriately.

**It is essential to ensure that:** The cold stored water capacity is adequate for the entire household requirements (e.g. minimum 136 litres (30 gal) for shower only, 227 litres (50 gal) per bathroom, or 364 litres (80 gal) for one bathroom plus an en-suite shower room).

There is a maximum static head of 10 metres (100kPa/1.0Bar).

Cold supplies to the cylinder and the pump are taken from the opposite side of the cold

Figure 1: Tank inlet and outlet position

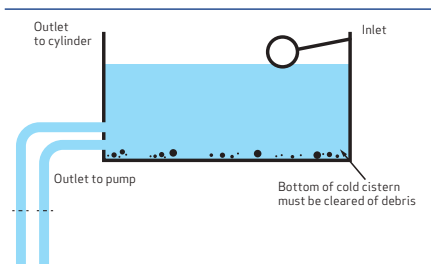

water storage cistern to the cold mains inlet.

The bottom of the cold water storage cistern must also be checked and cleared of debris (Figure 1).

In systems with more than two bathrooms, the cold water supply to the cylinder should ideally be in 28mm pipework.

Multiple cold water storage cisterns must be linked in accordance with the current plumbing regulations with the bottom



# Step 1: Pump location

1. Site the pump in a location where it will not freeze or be exposed to frost during cold weather.
2. Ensure adequate airflow to cool the motor. Separate the pump from other appliances that generate heat. Install the pump in a clear space allowing 100mm at each side, end and top.
3. Do not endanger pre-existing electrics when siting your Salamander pump
4. Ensure the pump is as close to the hot water cylinder as possible and no more than 5m in measured pipework away.
5. Mount the pump upright (shaft horizontal, not screwed down).
6. Where the pump is located above the hot water cylinder, it must be a minimum of 600mm below the cold water cistern. The best connection is a side entry cylinder connection in 22mm with an Anti-Gravity Loop (AGL) of 400mm (Figure 2), Alternatively, a top entry flange may be used, but the pump cannot be teed from existing feeds where it is located above the hot water cylinder. If aeration causes an issue, it may become a requirement to use an Essex Flange.
7. Bathroom Zones: Salamander products covered in these notes cannot be installed in Zone 0 or Zone 1. They can however be installed in areas that are accessible with a tool. (See Figure 3).

The pump should be installed in accordance with BS7671:2018.

In BS7671:2018 rooms containing baths or showers should be broken down into zones.

These zones are summarised as:

ZONE 0 – This is the bath or shower tray.

ZONE 1 – Is considered to be the area where the individual is bathing or showering or the area where shower water is likely to be directly sprayed.

ZONE 2 – Is the area beyond Zone 1, extending by a further 600mm.

Please refer to BS7671:2018 for further guidance.

Figure 3: Bathroom Zones

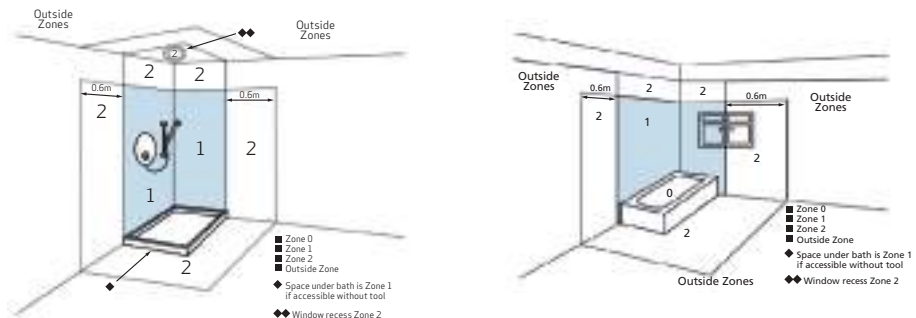



8. Check the marker arrows on the pump to ensure correct direction of water flow. Either end of the pump is suitable for hot or cold water.
9. Check the static inlet pressure does not exceed 10m max (1.0bar/100kPa) of water above the pump.
10. The hot supply pipework to the pump should be a maximum length of 5 metres in 22mm pipe (hot and cold supplies should be no more than 2 metres in 15mm pipe).
11. The best hot connection from the cylinder (Figure 5) is either with:
  - A ¾ inch no stop Essex flange, or a Salamander S flange or other approved top entry flange.
12. Exceptions, only when pump is at the base of the cylinder and within 5m, are:
  - alternatively, the hot and cold supplies to the pump can be teed off other 22/28mm supplies (Figure 4) provided that:
    - the tee off to the pump is first call on the downward leg after the vent connection.
    - the cold supply to the pump is not shared with the cold feed to the cylinder.
    - hot supply from the vent angled at 45°, vertically down the hot connection at the vent, at least 1.5 metres below the base of the cold water storage cistern.
13. Check that water storage capacity recovery meets required flow rates, particularly at peak demand (i.e. appliances in simultaneous use).
14. All up and over pipework must be vented at the highest point on the outlet of the pump.
15. Ensure that pipe runs minimise airlocks.
16. In positive head systems, allow for increased resistance of long pipe runs with multiple bends. The natural flow from the shower head or other outlets must be at least 2 litres/minute at all time on both hot and cold individually. Any supply where the natural flow is less than 2litres/minute is classed as a negative head situation.

Figure 4. Tee off other supplies

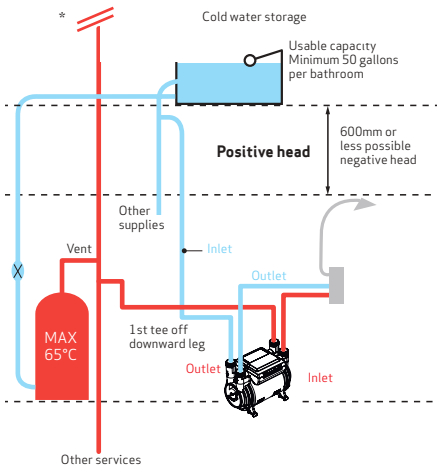
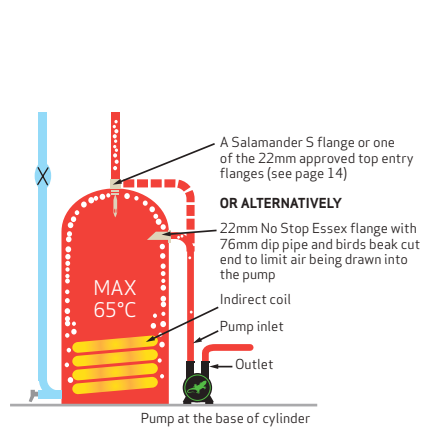

Figure 5. Best Connection Method



\*Vent and expansion pipe to terminate to current standards

# Negative head systems

Negative head systems exist where insufficient natural flow of water goes to the outlet because either the outlet or the pipework to the outlet are above the height of the base of the cold water cistern. Most instances of negative head systems occur in loft conversions or where the cold water cistern sits on the joists in the loft. If the distance between the bottom of the cold water cistern and the highest point in the system after the pump is 2 feet (610mm) or less, it is also possible that a universal pump will be required. Salamander's universal range of pumps activate the pump automatically even where insufficient natural flow exists.

UK CT pumps suitable for negative head operation are:  
CT FORCE 15 TU, 20 TU, 20 SU, 30 TU and 30 SU, and CT Bathroom 60BU & 80BU.

Irish CT pumps suitable for negative head operation are:  
CT FORCE 15 ITU, 20 ITU, 20 ISU, 30 ITU and 30 ISU, and CT Xtra 64HU, 69HU & 84HU.

Figure 6. Negative head system

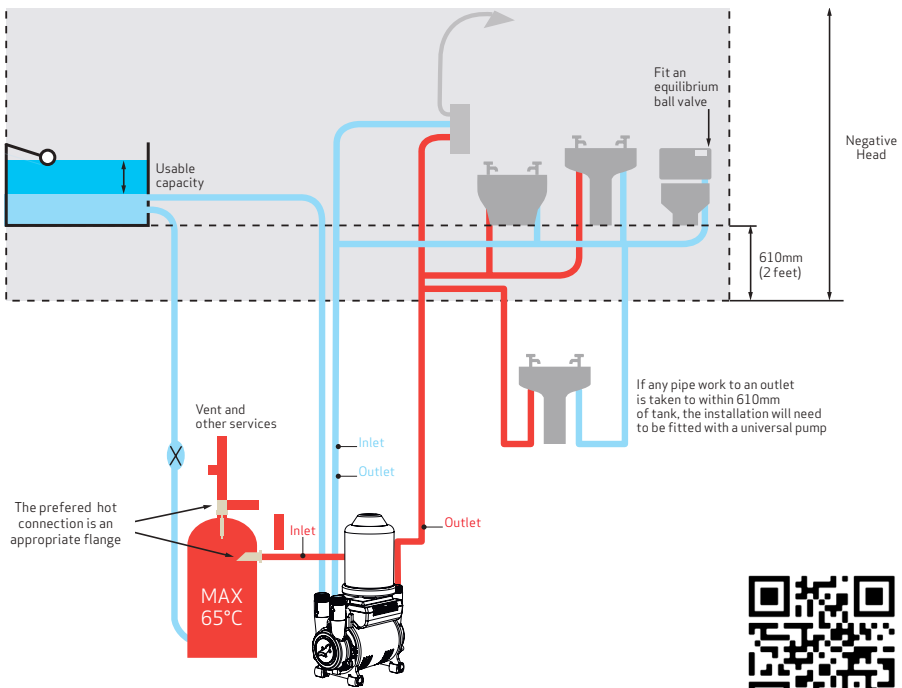

Scan QR to find out more

# Commissioning

## Before you finish

Fit pump inlet filters and vibration dampening feet.

**It is CRITICAL to discharge water through the pump into a container using natural flow before connecting the pump to outlet pipework in order to ensure the air has been discharged from inlet pipework and pump chambers. This will not happen if the outlet pipework is connected to the pump. The best method is:-**

- Connect discharge pipework, not outlet pipes.

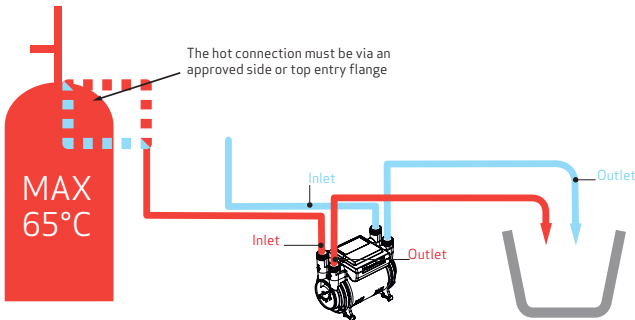

- **Check that all the AV coupler isolating valves are open.**
- Fill system. Check for leaks.
- **DO NOT RUN PUMP DRY - to do so will cause irreparable damage to your pump and will invalidate your warranty.**
- Open shower mixer valve/system outlets to maximum hot and cold to check the natural flow (unpumped) MUST be at least 1 litre in 30 seconds per side and 2 litres in 30 seconds mixed for positive head pumps.
- Open hot water outlets fully for 5 to 6 seconds and then turn outlets off. Then open cold water outlets fully for 5 to 6 seconds and turn outlets off. If flow is poor and inconsistent repeat above steps until flow is steady.
- Repeat 2-3 times

# Step 2: Connecting the pump

Use only Salamander supplied AV couplers to connect the pump.

! All associated pipework **MUST** be thoroughly flushed before making final connections to the pump. Fill the pump with water before connecting to the discharge pipework.

● **The in-line strainers must be fitted to the hot and cold inlet supplies to the pump.**

## A Hose to pipework

The anti-vibration coupler nuts need only be finger tight plus one quarter turn. Mechanical tools must not be used to tighten plastic coupler nuts as this may cause damage which will invalidate the warranty.

## B Hose to pump

Do not twist or bend anti-vibration hoses as this will invalidate the warranty.

Ensure that there are suitable means of isolation for maintenance

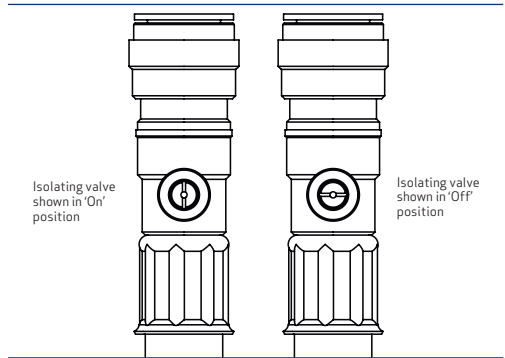

! **Filter washers MUST be fitted to the inlets of the pump to validate your warranty. Flat washers must be fitted to the outlets. Flat and filter washers are supplied with the pump.**

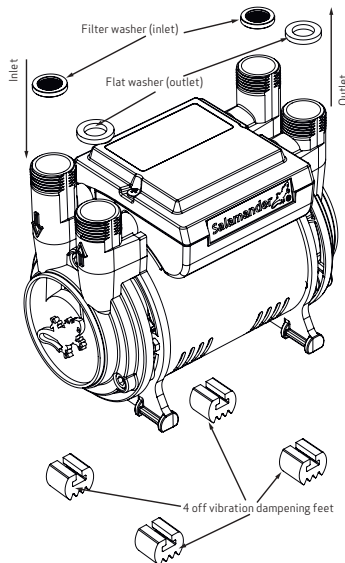

# Step 3: Electrical installation

Your pump must be connected to the electrical supply using the main cable with the attached plug. This plug must be connected to an accessible socket that has been installed in compliance with IET Wiring Regulations.

The plug must be accessible at all times.

If the supply cord is damaged, it must be replaced by the manufacturer, it's service agent, or similarly qualified person in order to avoid a hazard.

All pipe work must be cross-bonded in accordance with the IET Regulations.

The pump is supplied with a fuse fitted. Higher rate fuses MUST NOT be used.

If installed by a Part P qualified installer, the pump may be fitted via a fused mains spur without invalidating the warranty. See Technical Specifications for fuse ratings for each model of pump. Ensure that the pump is fully operational before hard wiring pump in this instance, this should be done during commissioning.

# Helpful Pumpwise guidelines

## Cold water supplies and storage Recovery of cold storage

Ensure that there is sufficient water recovery to cover the water usage by the appliance.

### Aeration of pump and cylinder from a cold water storage cistern

This occurs when the incoming cold mains ball valve is positioned above the cold feeds to the cylinder and to the pump – aerated water is drawn into the pump as illustrated.

Figure 7: Aeration

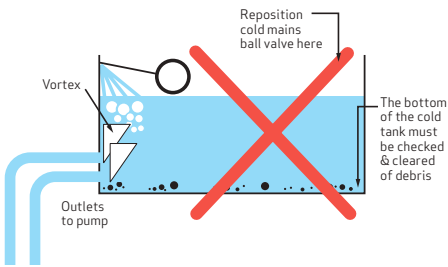

Chronic aeration of the pump occurs when this problem is combined with inadequate storage capacity and/or when the volume of water is drawn by the pump and other services exceeds the refill rate and creates a vortex which draws air and possibly debris into the pump.

### Cold storage usable capacity

The usable capacity of cold storage is easily calculated as the capacity of water in the cold cistern above the cold feeds to the cylinder, the pump and other outlets – see formula.

#### Formula for calculation on rectangular cistern:

Figure 8: Water capacity calculations

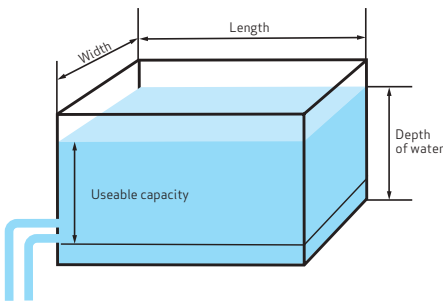

Water above inlet (15") x width (23")  
x length (36") = 12,420 cu inches

Volume cu inches (12,420) x 0.01639  
= 203.56 litres

Volume litres (203.56) x 0.22 = 44.78  
gallons



Scan QR to find out more

Figure 9: Water starvation protection unit (WSP)

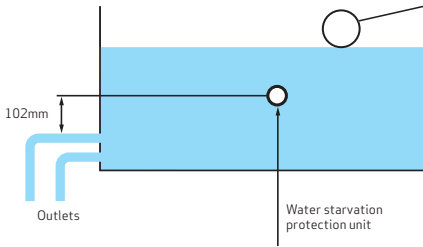

## Water starvation protection

In systems where it is absolutely not possible to increase the usable cold water storage capacity to meet the increased demand of a pumped system; a water starvation protection unit (WSP) may be considered (See fig 9).

The WSP is a Salamander level switch which must be positioned 102mm higher than the highest outlet from the cold water storage cistern. When the water level drops too far the WSP will switch off the pump until the cold water storage level is recovered.

## Combi boilers and water heaters

As these appliances are invariably supplied directly from the cold mains – Please see the Salamander MainsBooster Range, these pump are not suitable to pump from a Combination Boiler or Unvented Cylinder.

## Horizontal cylinders

As horizontal (Torpedo) cylinders are problematic for boosted systems consult PumpWise on 0191 516 2002 for guidance and correct use of an approved top entry flange.

## S flange

Complete with compression pump outlet and the open vent connections. Also supplied with an adaptor to connect to 1" male and female top entry cylinders. (See fig 10).

Figure 10: S flange

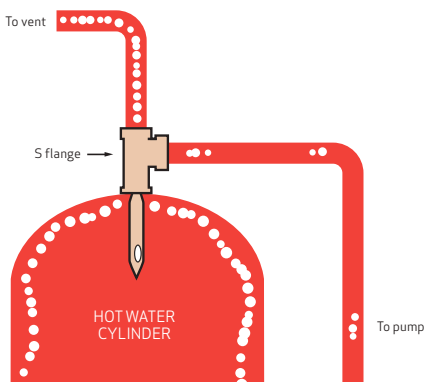

Scan QR to find out more

## Approved flanges (cylinders)

The 22mm No Stop Essex and the other approved top entry flanges with extension pipes into the cylinder represent the best known means of ensuring minimal aeration of the hot supply water to the pump.

Please contact PumpWise on 0191 516 2002 for additional approved flanges.

Warix flange (fig 11)

- A) The vent connection MUST be from side in Warix flange.
- B) The supply connection to the pump MUST BE FROM THE TOP of the Warix flange.
- C) In systems where there are one bathroom and an en-suite shower, or two or more bathrooms, the cold feed to the cylinder should ideally be in 28mm pipework.

Figure 11: Approved flanges

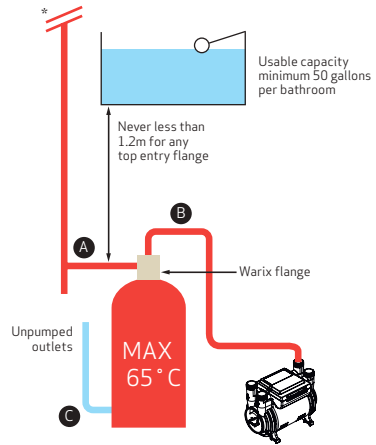

\*Vent and expansion pipe to terminate to current standards

## Water hammer protection

Water hammer most commonly occurs in systems where there are long pipe runs supplying solenoid activated appliances e.g. washing machines or outlets with quick acting/turn taps/valve(s). The harmful effect of water hammer shock waves can be cushioned by fitting a pressure vessel unit, into the supply pipework as close as possible to the outlet from which the shock waves are originating.

Figure 12: Water hammer protection

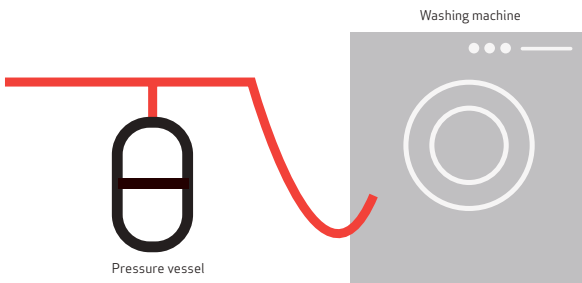



## **Pump hunting protection**

In negative head systems all the discharge pipework after the pump is pressurized.

In such systems there exists the possibility the pump will hunt ON-OFF-ON etc. at intervals.

This will happen:

- if all outlets are not fully closed
- if there is a leak at a connection
- if boosted toilets are not fitted with equilibrium ball valves
- or as residual hot water contracts in long pipe runs.

## **Stored hot water volume**

In calculating the volume of the stored hot water requirement it is important to consider:

- number of bathrooms, with particular attention to the size of the bath
- number of persons in household

## **Stored hot water temperature**

Extract from BS5546:2010

“The mean temperature of the stored water should not normally exceed 60°C and in a combined central heating and domestic hot water system it is recommended that the stored water temperature is controlled independently from that on the primary circuit”.

Effective control of stored hot water is simply achieved by use of a cylinder thermostat or direct acting thermostatic valve (e.g. tapstat).

Maximum water temperature for CT Xtra, CT Bathroom & CT FORCE pumps is 65°C.

In systems where the stored hot water temperature cannot be controlled e.g. Aga solid fuel appliance or very crudely by the boiler thermostat, a Salamander approved HWS TMV must be used.

## HWS TMV blending valve controller

A Salamander approved HWS Blending valve controller will protect booster pumps in systems where the temperature of the stored hot water is uncontrolled or crudely controlled via boiler thermostat only – see below.

Figure 13: HWS blending valve controller to pump

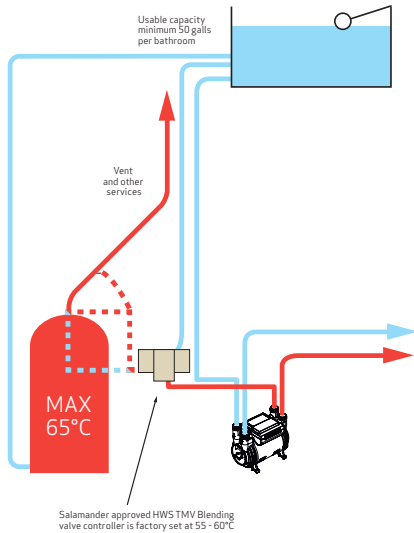
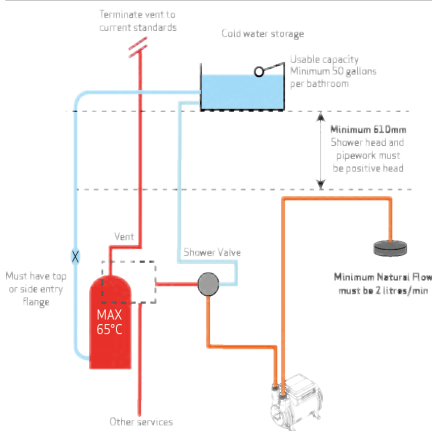

Figure 14: Pump fitted between shower valve and shower head



As a non-preferred method, a **single positive head pump** may be fitted between the shower valve and the shower head.

- The shower head and all pipework must be positive head and allow a natural flow of 2 litres per minute of mixed water.
- The hot water connection must be a top or side entry flange or secondary return connection on the cylinder
- Negative head pumps must not be used
- Supplies to shower should be no longer than 5m in 22mm pipe (2m of 15mm)

# General specifications – CT FORCE

## Applications

All Salamander pumps are designed to boost low pressure hot and cold supplies from cistern-fed services. When supplies from a water heater or a combination boiler are to be boosted contact the Salamander PumpWise helpline on 0191 516 2002 for guidance.

## Voltage

230 volts, 50 Hz.

## Motor type

Capacitor start and run induction type motor with stainless steel shaft and in-built resetting thermal protection (complies with BS5000 part 11).

## Maximum head

All Salamander CT FORCE pumps – 10 metres (100kPa/1.0Bar).

## Anti-vibration couplers

Do not bend

CT FORCE Pumps are supplied with AV couplers complete with Push Fit connections and built-in isolating valves. See Technical specifications for details.

## Mechanical seals

Rotary mechanical face seals are used. Scale deposits in water supplies can cause the mechanical seal to stick if left for long periods without use. The pump must be run at least five minutes every four weeks to 'exercise' all working parts.

## Connections

$\frac{3}{4}$ " BSP male.

## Initiation

Fully automatic, flow operated, requiring 2ltr/Min per side or 4ltr/Min mixed. Only applies to positive head pumps.

## Temperature

Maximum fluid temperature 65°C.

## Pump noise

Salamander has engineered this product range to be as quiet as possible, however no pump is completely silent. Correct installation (anti-vibration couplers straight, rubber feet fitted) will minimise noise, vibration and transmission noise.

## Standards and approvals

Splash proof rating IPX3; complies with the requirements of current British and European safety standards for household and similar electrical appliances; meets with Compliance with European Community Directives (CE). Due to continuous improvement and updating specifications may be altered without prior notice.

The CT FORCE range is fully WRAS approved and has been awarded Quiet Mark.



# General specifications – CT Xtra & CT Bathroom

## Applications

All Salamander pumps are designed to boost low pressure hot and cold supplies from cistern-fed services. When supplies from a water heater or a combination boiler are to be boosted contact the Salamander PumpWise helpline on 0191 516 2002 for guidance.

## Voltage

230 volts, 50 Hz.

## Motor type

Capacitor start and run induction type motor with stainless steel shaft and in-built resetting thermal protection (complies with BS5000 part 11).

## Maximum head

All CT Xtra and CT Bathroom pumps are rated for a maximum static head of 10 metres. (100 kPa / 1.0 bar)

## Anti-vibration couplers

Do not bend

**Please refer to the Technical Specifications table for information on which AV Couplers are supplied with each pump.**

## Mechanical seals

Rotary mechanical face seals are used. Scale deposits in water supplies can cause the mechanical seal to stick if left for long periods without use. The pump must be run for at least five minutes every four weeks to 'exercise' all working parts.

## Connections

¾" BSP male.

## Initiation

Only applies to positive head pumps. Fully automatic, flow operated, requiring 2ltr/Min per side or 4ltr/Min mixed.

## Temperature

Maximum fluid temperature 65°C.

## Pump noise

Salamander has engineered this product range to be as quiet as possible, however no pump is completely silent. Correct installation (anti-vibration couplers straight, rubber feet fitted) will minimise noise, vibration and transmission noise.

## Standards and approvals

Splash proof rating IPX3; complies with the requirements of current UK Regulations (UKCA) and European Community Directives (CE) safety standards for household and similar electrical appliances. Due to continuous improvement and updating specifications may be altered without prior notice.

The CT Xtra and CT Bathroom ranges of pumps are fully WRAS approved. CT Xtra has also been awarded Quiet Mark.



# Technical specifications - CT Force

Part No.	Description	Specification			Performance			Connection Type			Pump Volumetrics				Packed Pump Volumetrics			
		Electrical Input	Fuse	Pump Type				Pump	Hoses	Isolators	Dimensions				Dimensions			
		230/1/50		Regenerative	Pressure kPA/(Bar) at 16ltr/min	Pressure kPA/(Bar) at 8tr/min	Max pressure kPA/(Bar) closed head	BSP	Push Fit	Isolators integrated into the hoses	Weight (Kg)	Length (mm)	Width (mm)	Height (mm)	Weight (Kg)	Length (mm)	Width (mm)	Height (mm)
<b>CT FORCE</b>																		
Force 15PT Force 15IPT	1.5 Bar Twin End Positive Head Shower Pump	✓	3A	✓	110 (1.1)	130 (1.3)	150 (1.5)	3/4"	22mm 21mm	✓	5.00	186	120	160	6.06	298	218	205
Force 20PT Force 20IPT	2.0 Bar Twin End Positive Head Shower Pump	✓	3A	✓	150 (1.5)	180 (1.8)	200 (2.0)	3/4"	22mm 21mm	✓	5.01	186	120	160	6.07	298	218	205
Force 30PT Force 30IPT	3.0 Bar Twin End Positive Head Shower Pump	✓	3A	✓	220 (2.2)	260 (2.6)	300 (3.0)	3/4"	22mm 21mm	✓	6.26	216	120	160	7.38	298	218	205
Force 20PS Force 20IPS	2.0 Bar Single End Positive Head Shower Pump	✓	3A	✓	150 (1.5)	180 (1.8)	200 (2.0)	3/4"	22mm 21mm	✓	4.37	186	120	160	5.21	298	218	205
Force 30PS Force 30IPS	3.0 Bar Single End Positive Head Shower Pump	✓	3A	✓	210 (2.1)	260 (2.6)	300 (3.0)	3/4"	22mm 21mm	✓	5.65	216	120	160	6.52	298	218	205
<b>CT FORCE Universal Pumps</b>																		
Force 15TU Force 15ITU	1.5 Bar Twin End Positive and Negative Head Shower Pump	✓	3A	✓	110 (1.1)	130 (1.3)	150 (1.5)	3/4"	22mm 21mm	✓	5.57	186	125	315	6.79	298	218	360
Force 20TU Force 20ITU	2.0 Bar Twin End Positive and Negative Head Shower Pump	✓	3A	✓	150 (1.5)	180 (1.8)	200 (2.0)	3/4"	22mm 21mm	✓	5.61	186	125	315	6.86	298	218	360
Force 30TU Force 30ITU	3.0 Bar Twin End Positive and Negative Head Shower Pump	✓	3A	✓	220 (2.2)	260 (2.6)	300 (3.0)	3/4"	22mm 21mm	✓	6.83	216	125	315	8.14	298	218	360
Force 20SU Force 20ISU	2.0 Bar Single End Positive and Negative Head Shower Pump	✓	3A	✓	150 (1.5)	180 (1.8)	200 (2.0)	3/4"	22mm 21mm	✓	5.00	186	125	315	5.98	298	218	360
Force 30SU Force 30ISU	3.0 Bar Single End Positive and Negative Head Shower Pump	✓	3A	✓	210 (2.1)	260 (2.6)	300 (3.0)	3/4"	22mm 21mm	✓	6.24	216	125	315	7.28	298	218	360

# Technical Specifications - CT Xtra

Part No.	Description	Specification		Performance			Connection Type			Pump Volumetrics				Packed Pump Volumetrics				
		Electrical Input	Pump Type				Pump	Hoses	Isolators	Dimensions				Dimensions				
		230/1/50	Fuse	Regenerative	Pressure kPA/(Bar) at 16ltr/min	Pressure kPA/(Bar) at 8tr/min	Max pressure kPA/(Bar) closed head	BSP	Push Fit	Isolators integrated into the hoses	Weight (Kg)	Length (mm)	Width (mm)	Height (mm)	Weight (Kg)	Length (mm)	Width (mm)	Height (mm)
<b>CT Xtra Shower Pumps</b>																		
CT50+ Xtra	1.5 Bar Twin End Positive Head Shower Pump	✓	3A	✓	100 (1.0)	130 (1.3)	150 (1.5)	3/4"	15mm	✓ Inlet only	3.9	185	120	160	4.31	293	213	226
CT54 Xtra	1.5 Bar Twin End Positive Head Shower Pump	✓	3A	✓	100 (1.0)	130 (1.3)	150 (1.5)	3/4"	21mm	✓	3.9	185	120	160	4.49	293	213	226
CT75+ Xtra	2.0 Bar Twin End Positive Head Shower Pump	✓	3A	✓	130 (1.3)	170 (1.7)	200 (2.0)	3/4"	15mm	✓ Inlet only	3.9	185	120	160	4.72	293	213	226
CT79 Xtra	2.0 Bar Twin End Positive Head Shower Pump	✓	3A	✓	130 (1.3)	170 (1.7)	200 (2.0)	3/4"	21mm	✓	3.9	185	120	160	4.90	293	213	226
CT55+ Xtra	1.5 Bar Single End Positive Head Shower Pump	✓	3A	✓	110 (1.1)	135 (1.35)	150 (1.5)	3/4"	15mm	✓ Inlet only	3.8	185	120	160	4.07	293	213	226
CT59 Xtra	1.5 Bar Single End Positive Head Shower Pump	✓	3A	✓	110 (1.1)	135 (1.35)	150 (1.5)	3/4"	21mm	✓	3.8	185	120	160	4.15	293	213	226
CT85+ Xtra	2.5 Bar Single End Positive Head Shower Pump	✓	3A	✓	170 (1.7)	200 (2.0)	220 (2.2)	3/4"	15mm	✓ Inlet only	3.8	185	120	160	4.48	293	213	226
CT89 Xtra	2.5 Bar Single End Positive Head Shower Pump	✓	3A	✓	170 (1.7)	200 (2.0)	220 (2.2)	3/4"	21mm	✓	3.8	185	120	160	4.59	293	213	226

# Technical Specifications - CT Xtra H & HU, CT Bathroom B & BU

Part No.	Description	Specification		Performance			Connection Type			Pump Volumetrics				Packed Pump Volumetrics				
		Electrical Input	Pump Type				Pump	Hoses	Isolators	Dimensions				Dimensions				
		230/1/50	Fuse	Regenerative	Pressure kPA/(Bar) at 16ltr/min	Pressure kPA/(Bar) at 8tr/min	Max pressure kPA/(Bar) closed head	BSP	Push Fit	Isolators integrated into the hoses	Weight (Kg)	Length (mm)	Width (mm)	Height (mm)	Weight (Kg)	Length (mm)	Width (mm)	Height (mm)
<b>CT Bathroom &amp; CT H Xtra Shower Pumps</b>																		
CT60 B Bathroom	1.8 Bar Twin End House Pump	✓	3A	✓	130 (1.3)	170 (1.7)	180 (1.8)	3/4"	15mm	✓	3.98	185	120	160	4.76	293	213	226
CT64 H Xtra	1.8 Bar Twin End House Pump	✓	3A	✓	130 (1.3)	170 (1.7)	180 (1.8)	3/4"	21mm	✓	3.98	185	120	160	4.89	293	213	226
CT80 B Bathroom	2.6 Bar Twin End House Pump	✓	3A	✓	160 (1.6)	230 (2.3)	260 (2.6)	3/4"	15mm	✓	5.21	213	120	160	6.23	298	218	226
CT84 H Xtra	2.6 Bar Twin End House Pump	✓	3A	✓	160 (1.6)	230 (2.3)	260 (2.6)	3/4"	21mm	✓	5.21	213	120	160	6.51	298	218	226
<b>CT Bathroom &amp; CT HU Xtra Universal Pumps</b>																		
CT60 BU Bathroom	1.8 Bar Twin End Universal House Pump	✓	3A	✓	130 (1.3)	170 (1.7)	180 (1.8)	3/4"	15mm	✓	4.58	185	125	315	5.56	293	213	351
CT64 HU Xtra	1.8 Bar Twin End Universal House Pump	✓	3A	✓	130 (1.3)	170 (1.7)	180 (1.8)	3/4"	21mm	✓	4.58	185	125	315	5.91	293	213	351
CT80 BU Bathroom	2.6 Bar Twin End Universal House Pump	✓	3A	✓	160 (1.6)	230 (2.3)	260 (2.6)	3/4"	15mm	✓	5.81	213	125	315	7.00	298	218	351
CT84 HU Xtra	2.6 Bar Twin End Universal House Pump	✓	3A	✓	160 (1.6)	230 (2.3)	260 (2.6)	3/4"	21mm	✓	5.81	213	125	315	7.22	298	218	351

# Trouble Shooting

**CHECK THAT THE INSTALLATION COMPLIES WITH THE SALAMANDER INSTRUCTIONS IF THE PUMP IS STILL INOPERABLE, CONTACT PUMPWISE ON 0191 516 2002.**

Fault	Probable cause	Recommended solution
Pump will not start	Insufficient gravity flow	Check suitability of pump - is installation in negative head (see page 8) Check inlet filters are not blocked Check flow rate (min of 2l/min required on both hot and cold)
	Inlet/outlet connections incorrect	Check that connections are plumbed the correct way round and all valves are open
	Electrical	Check power supply Check fuse Check circuit breaker
	Debris under flow switch	Remove outlet hoses and check that flow switch sits in lowest position
	Float sticking in outlet	Ensure no debris is in outlet area
	Flow switch malfunction	Contact Technical Advice Line
Reduced/ intermittent flow	Incorrect or no anti-aeration flange fitted	Fit appropriate anti-aeration flange
	Insufficient gravity flow	See above
	Blocked inlet filters	Ensure that all filters and shower head are free from debris
	Couplers restricting flow	Ensure that all AV couplers are straight and not bent or distorted
	Air in system	Run system on full hot with pump switched off (i.e. gravity only) for several minutes Check cold water storage is correct for installation Ensure cold water refill rate is adequate for installation Check that vents are fitted as described in instructions
	Wrong size pump for system	Ensure pump is sufficient to run the equipment
	Hot temp set too high	Reduce cylinder stat setting to 65°C max or fit HWS/TMV
Pump starts with all outlets closed	Leak in system	Check for leaks
	Outlet open	Ensure all outlets are fully closed or capped - i.e. no dead legs in pipework
Pump is noisy	Air in system	See above
	Pump vibrating on surface	Ensure rubber feet are fitted to pump
	AV couplers causing vibration	Ensure that all AV couplers are straight and not bent or distorted
Pump is leaking	Pump exposed to mains water pressure	Fit break cistern or remove from mains supply
	Pump has suffered chemical damage	Ensure that the pump has not come into contact with chemical substance i.e. solder flux
	Pump exposed to excessive temperature	Is effective temp control fitted (cylinder stat or HWS/TMV valve)?
	Pump appears to have leaked but not sure	Check leak is not from fitting in pipework above pump
Pumps above hot cylinder becomes noisy/low pressure during use	Aeration or water starvation	An Essex flange may be required for the hot connection to cylinder. Ensure pump is a minimum of 600mm below the cold water tank.



# Salamander PumpWise

Salamander PumpWise is your guarantee to:

- help you select the right pump for the job.
- avoid installation pitfalls.

## PumpWise helpline 0191 516 2002

PumpWise from Salamander helps customers and provides a support service second to none. Installers and customers can be sure of a speedy response to requests for technical help, guidance and advice.

8.30am - 4.30pm Monday-Thursday

8.30am-2.30pm Friday

## Safety in operation

These appliances are not intended for use by persons (including children) with reduced physical, sensory or mental capabilities, or lack of experience and knowledge, unless they have been given supervision or instruction concerning use of the appliance by a person responsible for their safety.

Children should be supervised to ensure that they do not play with the appliance

## WEEE Directive

Your appliance contains valuable materials which could be recovered or recycled. At the end of the product's useful life please dispose of it at an appropriate civil waste collection point.



### WEEE Directive 2012/19/EU

At the end of the product life dispose of packaging and product in a corresponding recycling centre.

Do not dispose of the unit with the usual domestic refuse. Do not burn the product.

# Warranty

Salamander CT FORCE brass ended pumps benefit from a full five years warranty, CT Xtra and CT Bathroom pumps benefit from a full three years warranty (UK only).

## **PLEASE NOTE:**

### **Incorrect installation WILL invalidate the pump warranty**

Salamander Pumps operates a policy of continuous development and reserves the right to change any of the specifications of its products without prior notice. All information data and illustrations given in this leaflet may be subject to variation.

In order to get the most from your Salamander Pump:

- take care that the temperature of your stored water NEVER exceeds the recommended maximum of 65°C
- contact the PumpWise helpline at any sign of aeration or spluttering of the discharge water from the shower or other outlets

## **Our PumpWise commitment**

We promise to help you select the right pump and eliminate the risk of incorrect installation. We strive to design and manufacture a robust quality product that will delight our customers. We assure you that, should you experience a problem, the PumpWise helpline is there to help; our advisers will provide advice and, if necessary, arrange to fix the problem on site.

## **Further technical assistance**

For more details and further technical assistance consult PumpWise.

**Telephone:** 0191 516 2002

**Fax:** 0191 548 4445

**E-mail:** [tech@salamanderpumps.co.uk](mailto:tech@salamanderpumps.co.uk)

# To the installer

Please follow the guidelines for installation provided in this brochure and call the PumpWise helpline for installation advice.

Once the installation has been completed and the system has been tested to your satisfaction, please assist the customer in completing warranty registration.

Please note that Salamander Pumps are able to provide an on-site service visit which may be chargeable.

## 1 The Scope of the Warranty

SALAMANDER PUMPED SHOWER SYSTEMS LTD (“the Company”) Warrants subject to the terms and conditions below for the Warranty period(s) specified in paragraph 3 that the Company shall:

Repair or replace free of charge the product(s) specified on the Online Warranty Registration or Telephone Warranty Registration any component part thereof (together referred as “the equipment”) which shall in the opinion of the Company have proved defective by reason only of the Company’s materials or workmanship. The Company shall be under no obligation whatsoever under this Warranty to repair or replace equipment which has been misused, tampered with, or modified/altered in any way without the consent in writing from the Company; or if any component or accessory has been replaced by a type not specified by the Company; or if the equipment is incorrectly installed, operated or used other than as described in the instruction manual; or if any servicing or repair of the equipment shall have been carried out by anyone other than an authorised Company dealer appointed by the Company (“dealer”).

The Company’s liability under this Warranty is limited to the said repairs or replacement and shall under no circumstances extend to any financial loss or damage including consequential losses alleged to have been suffered by the claimant.

Subject as provided in this warranty and except where the equipment is sold to a person dealing as a consumer all warranties, conditions or other terms implied by law are excluded to the fullest extent permitted by law.

Nothing in this warranty shall exclude liability for death or personal injury caused by the Company’s negligence.

## 2 Terms and conditions

This Warranty shall only be enforceable by you if the following terms and conditions have been complied with:

- a. That the pump has been installed in accordance with the installation instructions, guidance and advice contained within the installation and warranty guide and/or provided by the Salamander help desk.
- b. You are the original purchaser of the equipment from a dealer and not an assignee or subsequent purchaser of the equipment.

- c. You must evidence the date of purchase by retaining the original invoice from the dealer. Without such evidence the Company reserves the right to reject any such claims under the terms of this Warranty.
- d. Within 15 days of purchase of the equipment the Warranty registration is accurately completed online or over the telephone.
- e. Within 30 days of discovery of a defect giving rise to liability under paragraph 1 above you give notice thereof in writing to the Company.
- f. Provided the pump has not been altered, tampered with, modified or transformed in any way.

### **3 The Warranty periods**

The Warranty periods referred to in paragraph 1 above are as follows:

- a. i. CT FORCE (UK only) products manufactured by the Company 5 years from date of purchase provided the warranty registration is completed online or over the phone within 15 days of purchase. (Pumps purchased prior to 1st November 2015 come with 3 years warranty).
- ii. CT FORCE (ROI only) products manufactured by the Company 5 years from date of purchase provided the warranty is completed online or over the phone within 15 days of purchase. (Pumps purchased prior to 1st January 2016 come with 2 years warranty).
- iii. CT Xtra & CT Bathroom (UK only) products manufactured by the Company 3 years from date of purchase provided the warranty registration is completed online or over the phone within 15 days of purchase.
- iv. CT Xtra & CT Bathroom (ROI) products manufactured by the Company 2 years from date of purchase provided the warranty registration is completed online or over the phone within 15 days of purchase.
- b. Products supplied by the company, but are not of the company's manufacture come with 30 day warranty from date of purchase. Anti-Vibration Couplers (hoses) come with 1 year from date of purchase.
- c. The warranty period in respect of any product repaired or replaced under the warranty shall be part of the above period(s) which remain unexpired.
- d. In the event of a claim for repairs or replacement being made under the terms of this Warranty, a visit from a Salamander service engineer may be necessary. Engineer visits are not covered under/part of the warranty agreement. In circumstances where in the opinion of the Company the defect has not been caused by the Company's materials or workmanship then the Company reserves the right to charge the claimant at its current hourly rates and list prices in respect of any service engineer's time and replacement of any parts. Please speak to PumpWise for further details and confirmation of costs. Be advised in order for the pump to be assessed by an on-site engineer the pump must remain in situ.

- e. This Warranty is given in addition to and does not affect your statutory rights as a consumer.
- f. This Warranty is valid and enforceable for equipment purchased and used exclusively in the UK and The Republic of Ireland only.
- g. Where the Company issues a replacement the equipment replaced shall be returned to the Company forthwith and shall become the property of the Company.
- h. No authority has been given to any person, firm or company to vary the terms of this Warranty.











Get in touch, we're here to help  
call us on 0191 516 2002

Unit 2c Colima Avenue  
Enterprise Park West  
Sunderland, SR5 3XE



**Register your warranty**

Apply online at:

[www.salamanderpumps.co.uk](http://www.salamanderpumps.co.uk)

Apply by phone:

0191 516 2002

