

## SINGLE SLIDING DOOR

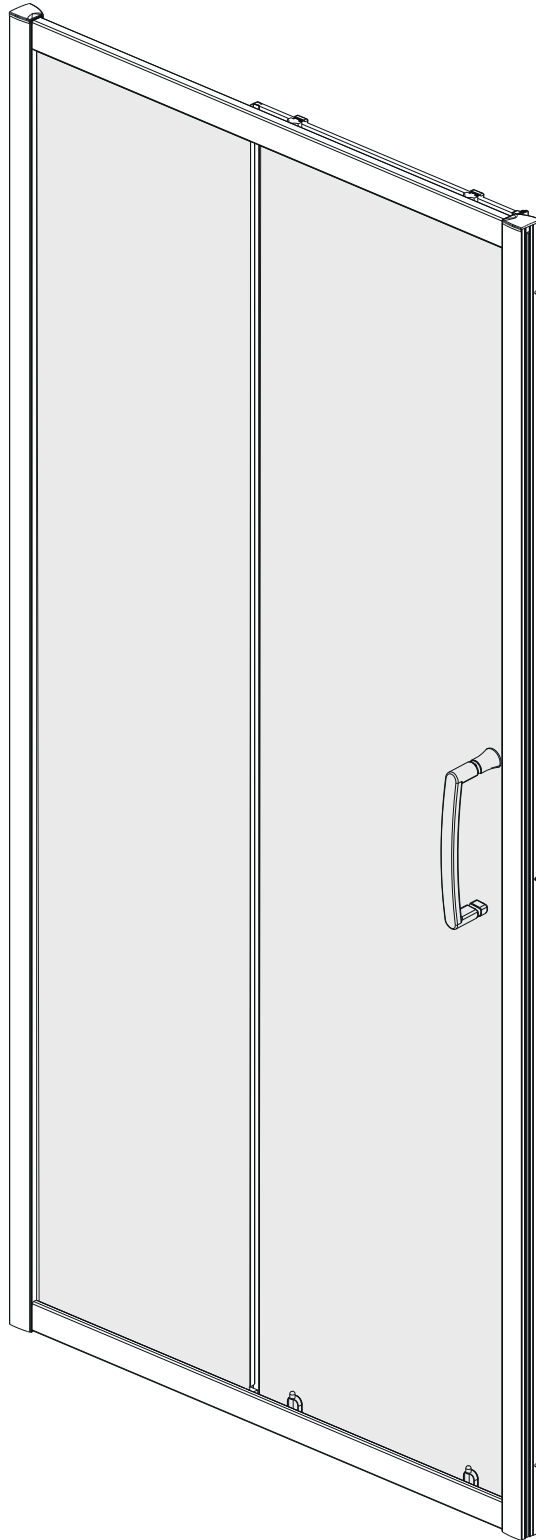

## INSTALLATION INSTRUCTIONS

## IMPORTANT

Please familiarise yourself with the fitting instructions before commencing fitting.

1. Check that you have the tools required.
2. Check that the installation site is compatible with size of door supplied.
3. Check all the enclosure components.
4. Check that the installation kit is complete.



**DO NOT attempt** to install the product unless you can tick ALL 4 boxes as satisfactory.

The wall plugs supplied with the installation kit are for use in solid walls. Hollow or 'stud-partition' walls will require alternative fixings. Please consult a hardware supplier for the correct type.

It may also be necessary to consult your tiling supplier about the correct method for drilling your tiles.

**USE SAFETY EYEWEAR WHEN DRILLING**

Any parts missing or damaged must be reported to your supplier within 5 days of purchase.  
Inspect shower enclosure before fitting. No claims will be acceptable after product has been installed.

## COMPONENTS AND BOX CONTENTS

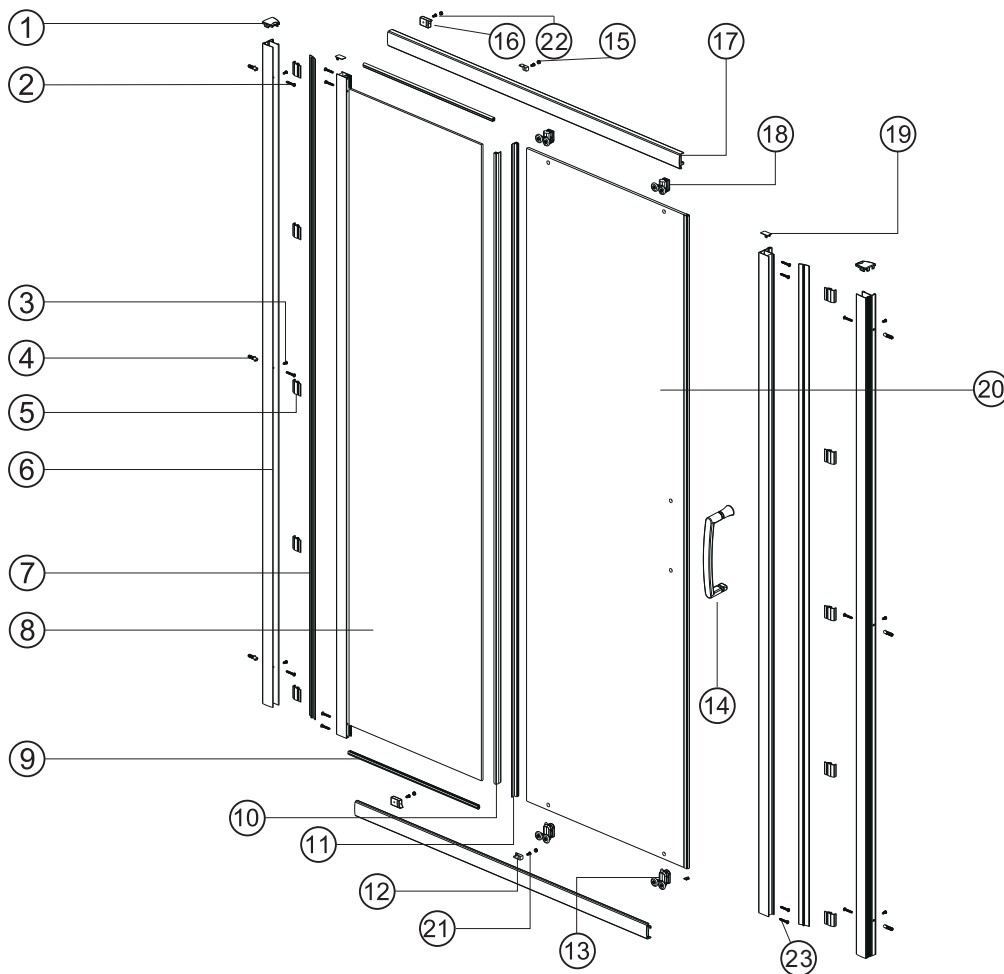

No.	Description	Qty	Part No.	No.	Description	Qty	Part No.
1	Cover cap for wall profile L/R	2	B08150/B08151	13	Bottom roller	2	B08075
2	Screw ST4x30	6	A2403001	14	Handle	1	B
3	Flat head screw ST4x12	6	A2401201	15	Glass clip cover cap	2	B08069
4	Ø6x30 wall plug	6	BB6304	16	Roller stop L/R	2	B08065 L/R
5	Cover strip clip	10	B08147	17	Top and bottom rail	2	C
6	Wall profile	2	B08135	18	Top roller	2	B08074
7	Cover strip	2	B08138	19	Cover cap for upright profile	2	B08152
8	Flat fixed panel	1	A	20	Moving panel	1	D
9	Bottom seal	2	B08146	21	Glass clip screw ST4x10	2	B08089
10	Upright water seal for fixed panel	1	B08117	22	Roller stop screw ST4x10	2	B08089
11	Upright water seal for moving panel	1	B08080	23	Screw ST4x40	8	B08129
12	Glass clip L/R	2	B08120/B08121				

## FIXING KIT COMPONENTS, TOOLS REQUIRED

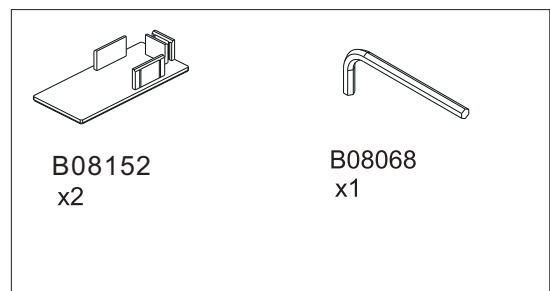
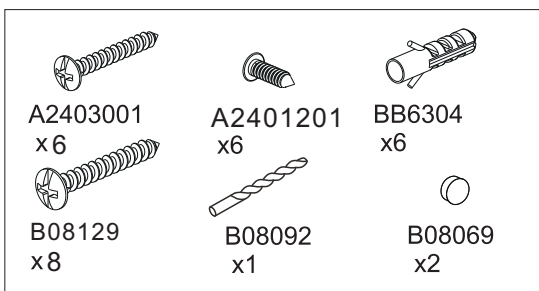
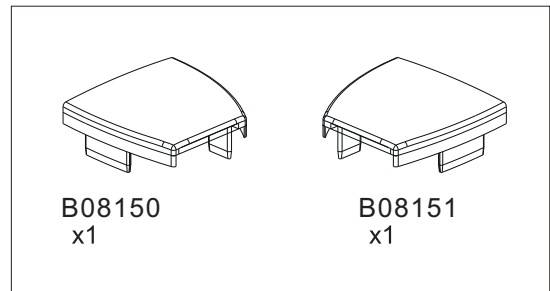
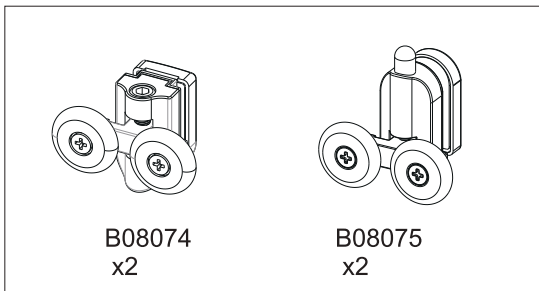

Handle as supplied in carton may be different than shown

### Tools Required

- 6mm masonry drill bit
- Spanner
- Power drill
- Quality Silicone
- Pencil
- Tape Measure
- #2 Philips Head screw driver
- Spirit level with horizontal and vertical level indicators

### IMPORTANT – Installation site

1. Ensure the top surface of the shower tray on which the enclosure will be installed is level in every direction.
2. The tiles or other wall finishing should be effectively sealed at the tray edges.
3. Tiles should extend at least to the corners of the tray and a minimum of 2.0 metres from the top of the tray.

# FITTING FRAME

## PROCEDURE

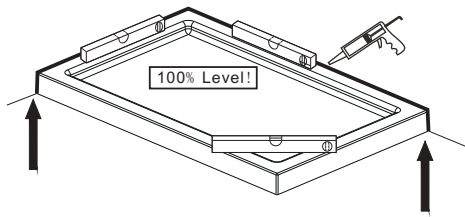

**TRAY MUST BE 100% LEVEL IN ALL DIRECTIONS.**

Ensure the shower tray is level in all directions and is properly sealed to the wall. The wall must be tiled down to the top edge of the tray. Do not angle out bottom tile.

**TRAY MUST BE SEALED FULLY AROUND WHERE THE TRAY MEETS THE WALL.**

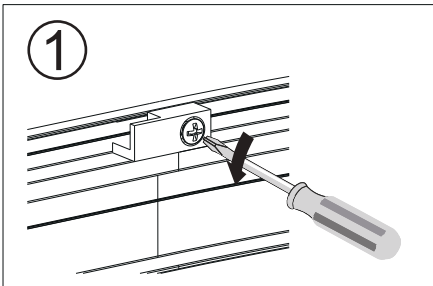

### Step 1

Loosen fixed glass panel clip.  
Do not remove the screw.

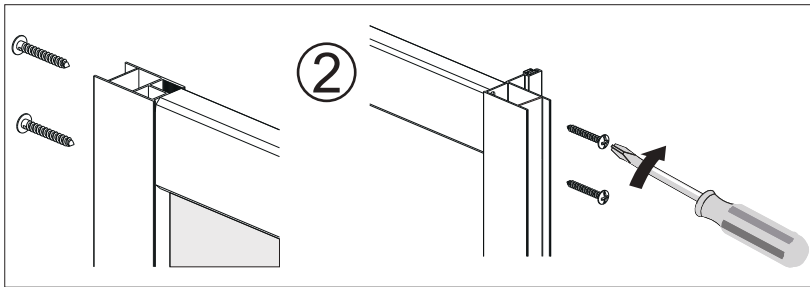

### Step 2

Fix the two fixed panels and upright profiles to the top bottom rail, using B08129 screw.

### Step 3

Put a dab of silicone in the corner between glass panel and fixed clip to the bottom when sliding the clip under the glass and back into position.

**Ensure bottom seal is present on glass, remove small corner protector/seal if present.**

