

## INSTALLATION INSTRUCTIONS

### Thermostatic Three Tap Hole tap, with pop up (excluding tap heads & base) - T26

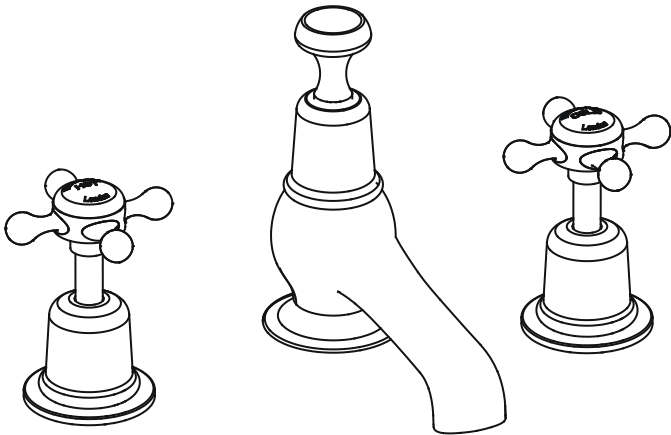

\* The package in this product has no handles or bases supplied.  
The handles shown in the diagram are for reference only.

#### Option 1:

Burlington has 3 different style handle for your selection.

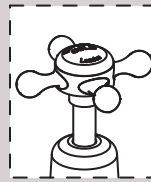

Claremont

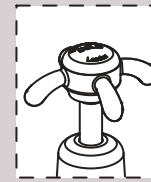

Anglesey

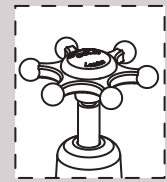

Birkenhead

**NOT INCLUDED IN THE TAP BOX**

#### Parts List :



1x



1x

### Important

- We recommend that this product is installed by a qualified professional contractor. Such as a plumber who is certified by NVQ (National Vocational Qualification) or SNVQ (Scottish National Vocational Qualification) Level 3
- Please check this product immediately to ensure that it has not been damaged and is complete. Before installation, please make sure this product is the correct model and you have all the parts required for installation and using.
- This valve is a mixing device and therefore requires the water supplies to be reasonably balanced, otherwise we recommend a pressure reducing valve to be fitted.
- Please flush the water system to ensure that no metal swarf, solder, and other impurities can enter the taps.
- Turn off water supply before commencing work, this should be done at the isolating valves of inlet feeds if fitted or main stopcock.
- Please read these instructions carefully and keep it for future reference.

### Conditions for the use of thermostatic mixing valve

The thermostatic valve has been designed to be compliant with the relevant UK standards applicable to this type of product governed by TMV2 standards and WRC. The valve is tested against BS EN 1287 & BS EN 1111.

The valve will operate under low pressure but it is recommended that the cold water supply is at least 2 meters from the outlet of the shower valve.

- This thermostatic valve is suitable for use with all water systems up to a maximum operating pressure of 5.0 bar, (beyond which we recommend pressure reducing valves to be fitted.)
- The valve is provided with one outlet (on the top), which is controlled by a flow control cartridge. Commonly used for a main shower head or a flexible shower kit.
- An independent, flexible hot and cold water supply pipe is recommended for use to easy maintenance.
- If installing a shower pump always install the pump before the shower valve.

The list below shows the recommended limits for correct operation;

|                                 | Low Pressure              |
|---------------------------------|---------------------------|
| Maximum Static Pressure – Bar   | 10                        |
| Flow Pressure, Hot & Cold - Bar | 0.1 to 5                  |
| Hot Supply Temperature - °C     | 55 to 65                  |
| Cold Supply Temperature - °C    | Equal to or less than 25° |

The British Burns Association recommends 37 to 37.5°C as a comfortable bathing temperature for children. In premises covered by the Care Standards Act 2000, the maximum mixed water outlet temperature of 43°C.

## Straightener and aerator (alternative options)

The tap comes with a factory-fitted flow straightener for low pressure water systems. If the water flow is high, replace the factory-fitted flow straightener with the high pressure aerator supplied.

Use NEOPERL Key to unscrew the straightener in the Nozzle. Replace with the aerator provided, and screw back in nozzle tightly. (If you misplace the Neoperl key you can use the top of the aerator/straightener as a key)



FLOW STRAIGHTENER

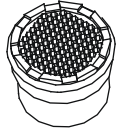

AERATOR

## Cleaning

Before use: Unscrew the filter and allow the water to run freely for 5 minutes. Then screw the filter back in place.

Periodically: Using the key provided unscrew the nozzle and remove. Rinse it with cleaning running water until any loose debris is cleared. Then replace the nozzle and tighten with key provided.

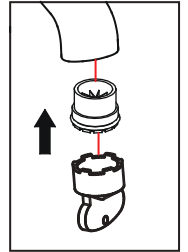
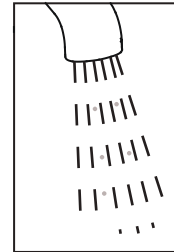
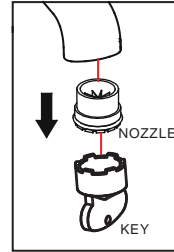

We do NOT recommend you use any household cleaners to clean the product. Because these cleaners change substance or formula too frequently. So product should be always cleaned only with soapy water and rinsing with clean water and drying with soft cloth.

## Dimension

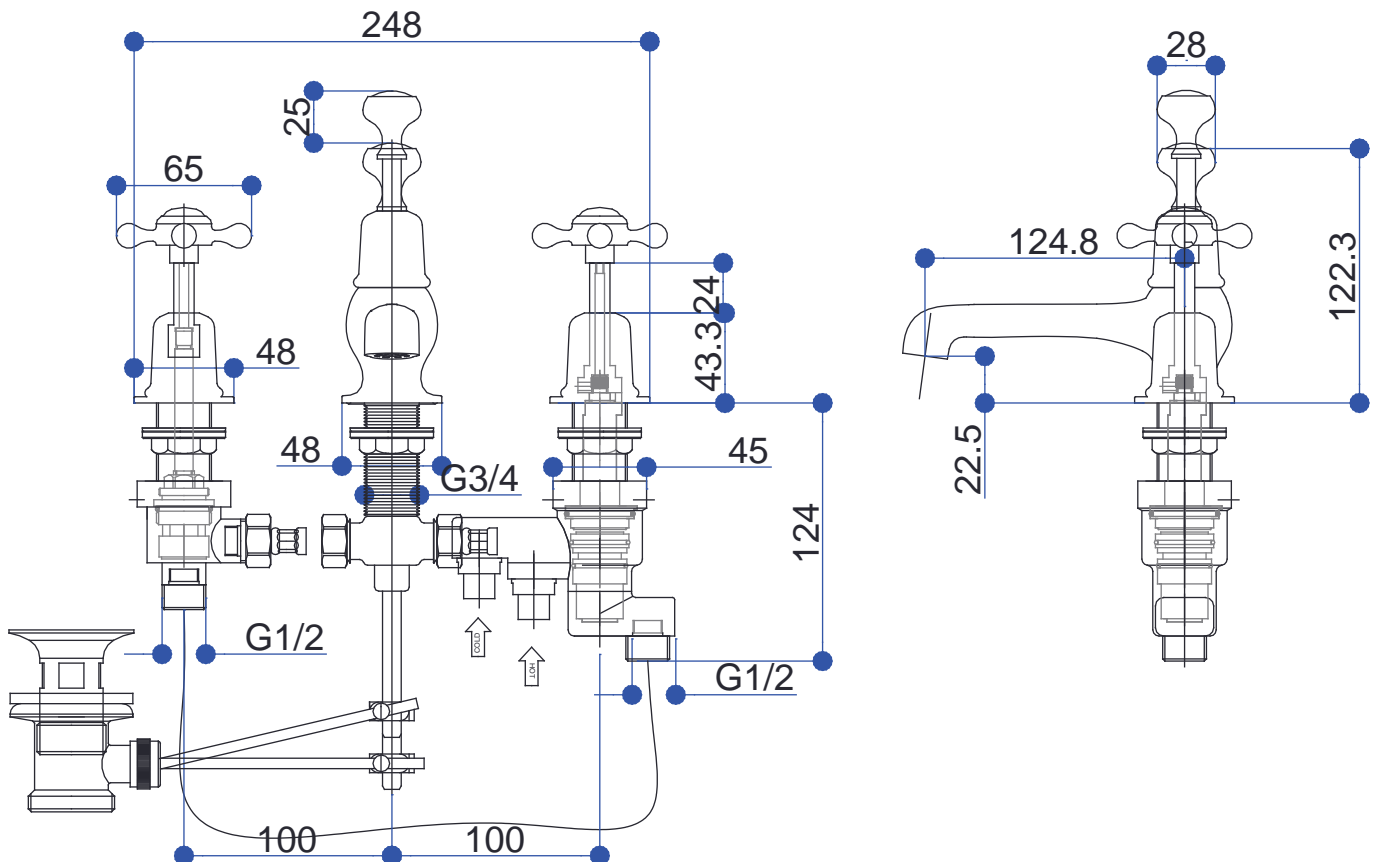

# Installation

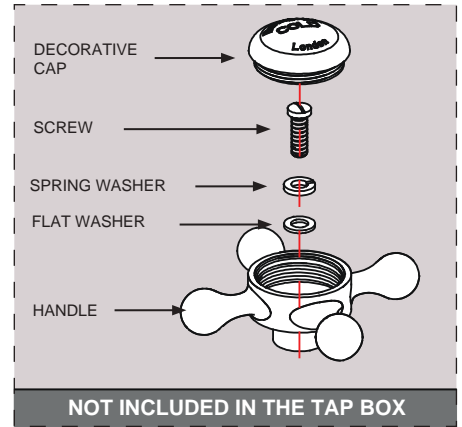
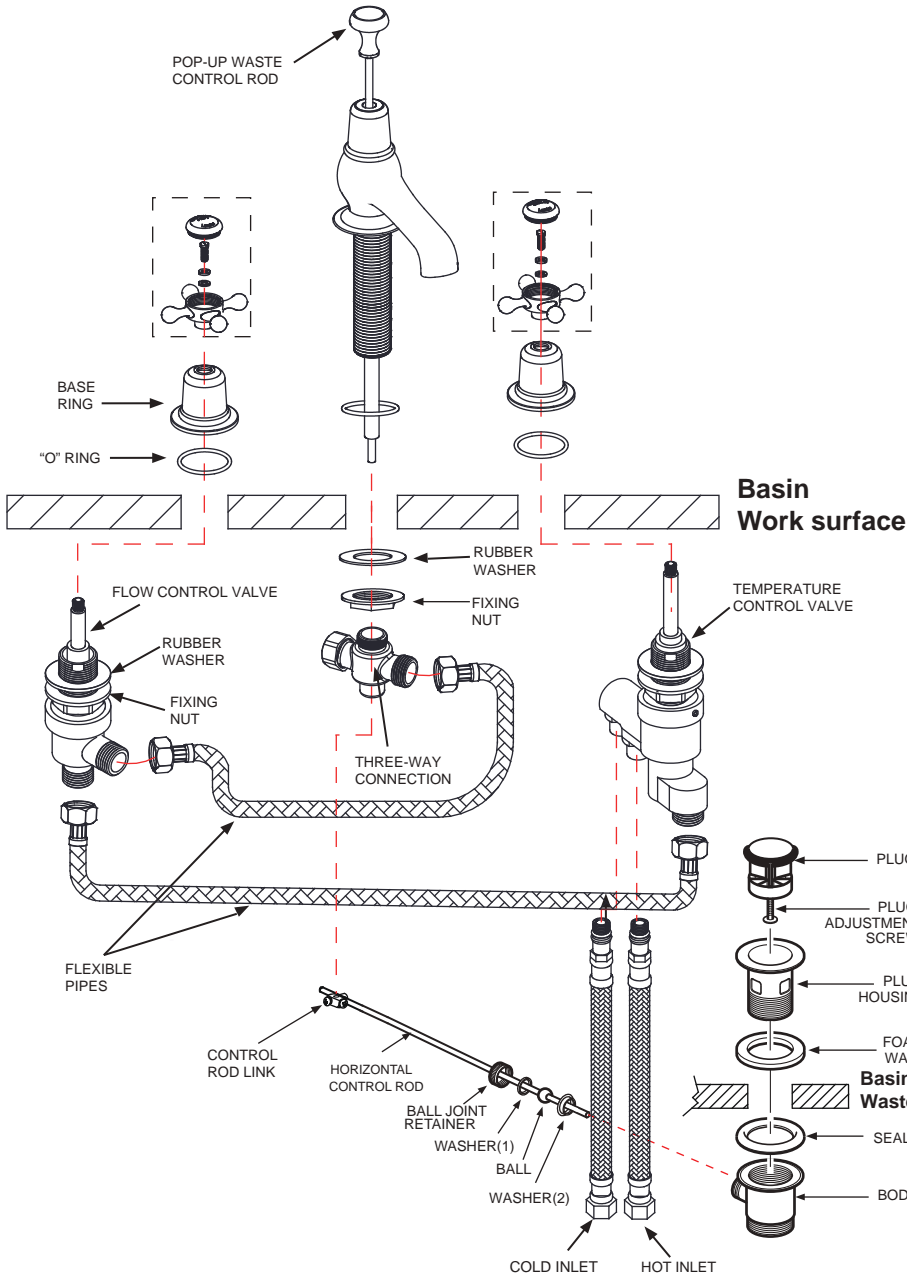

Note: Replace the ceramic indices on the handles with the ones supplied with T26. To ensure the Kensington lever tap head faces in the correct forward position once installed, you may need to tighten the cartridge into the tap body a notch with a monkey spanner and then re-attach the tap head.

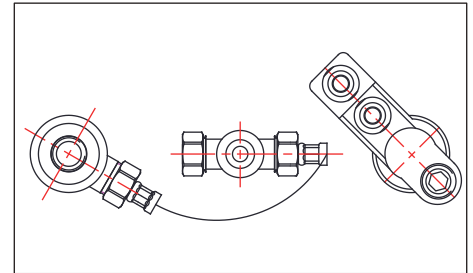

Note: Bottom view for the recommended installation.

1. Install the Central main body part:
  - a) Fit the "O" ring into the groove on the underside of the tap main body.
  - b) Then insert the tap main body into the centre hole on the basin from above.
  - c) Tighten the fixing nut and fix the main body on the basin.
  - d) Screw on the three-way connection at the tail of tap main body.
2. Install the flow control valve and temperature control valve:
  - a) Fit the "O" ring into the groove on the underside of both tap valve shroud.
  - b) Screw the rubber washer and fixing nut onto the valve .
  - c) Insert the two valve bodies into left and right holes on the basin from bottom.
  - d) Tighten the valve shroud and fix it together with the valve body.
3. Use the flexible hose to connect from the flow control valve to the middle three-way connection. If the hose conflict with the ceramic, please loosen the three-way connection slightly to ease the installation.
4. Use the flexible hose to connect from the temperature control valve to the flow control valve.
5. Connect the water supply pipes to the temperature control valve.
6. Install Pop-Up Waste:
  - a) Insert the Pop-Up control rod into the tap main body .
  - b) Insert the pop up waste on the basin and tighten.
  - c) Insert the horizontal control rod into the waste, and tight the ball joint retainer to make sure the ball with two washers on bath sides are fix with the waste.
  - d) Connect the pop-up control rod with the horizontal control rod.
  - e) Test the pop-up waste function, adjust the connection between pop-up control rod and horizontal control rod , or the ball joint retainer if necessary.

The valve should be installed in accordance with the water by-laws. For further details refer to the latest copy of Water by-laws guide or your local water authority.

## Operation

1. Turn the water flow control handle to increase/decrease the water flow and turn on/off.
2. Turn the temperature control handle to increase/decrease the water temperature.

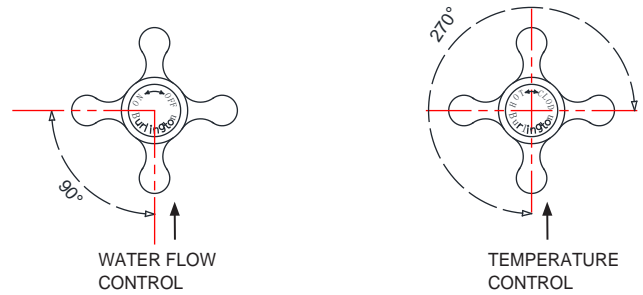

## Temperature Setting

The temperature control handles on this product are factory set and should require no adjustment.

However, if for any reason the handles and/or the cartridge is removed it is important the following procedure is followed.

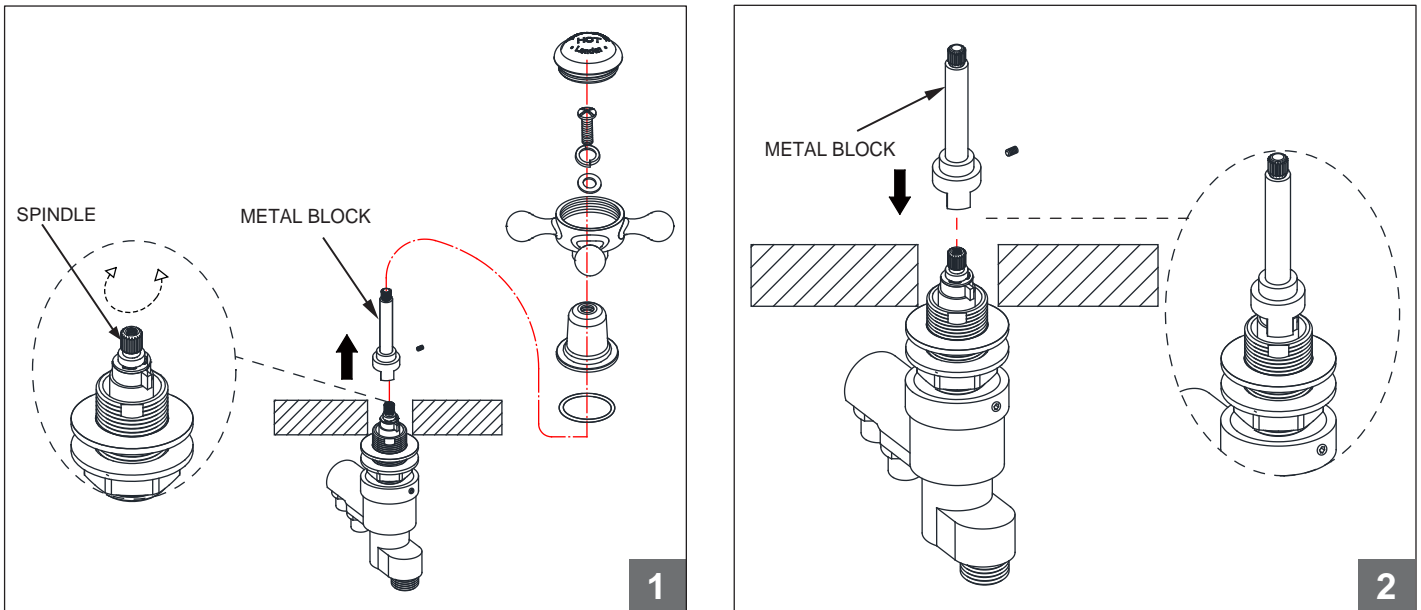

- 1) Remove the temperature control handle, metal block as the above diagram.
- 2) Rotate the exposed thermostatic spindle (clockwise for cold, and anti-clockwise for hot), until the maximum desired showering temperature is set. The suggested maximum "pre-set" temperature is 42°C. (See Fig 1)
- 3) Without any move at the spindle, replace the metal block so that the limit stop is up to the right hand side of the limit stop on the cartridge (See Fig 2).
- 4) Then refit the temperature control handle.

## Commissioning & Annual Test

The installation of thermostatic mixing valves must comply with the requirement of the Water Supply (Water Fittings) Regulations 1999. TMV2 approve valve must be tested once a year, to check if it is out of the original maximum temperature set.

1. Prepare a calibrated thermometer.
2. Adjust to maximum water temperature.
3. Allow water running 5 seconds for stability, measure the mixed water temperature at the outlet.
  - The mixed water temperature at the outlet should never exceed 42°C for showers.
  - The mixed water temperature at the outlet should never exceed 46°C for bath filler.

### Note:

46°C is the maximum mixed water temperature from the bath tap. The maximum temperature takes account of the allowable temperature tolerances inherent in thermostatic mixing valves and temperature losses in metal baths. It is not a safe bathing temperature for adults or children. The British Burns Association recommends 37 to 37.5°C as a comfortable bathing temperature for children. In premises covered by the Care Standards Act 2000, the maximum mixed water outlet temperature is 43°C.

IF NOT, then the adjustment of the temperature is necessary following the "Temperature Setting"

4. Close the isolating valve at the Cold water supply. While the flowing is residual, and the water temperature has no any change obviously from the initial maximum temperature set.
5. Reopen the Cold supply, retest the water temperature. if also having no change obviously. Then the valve is working correctly, no further service work is required.

## **Maintenance**

- \* After a long time usage of thermostatic valve, there will be some waste debris from the water pipe on and around the check valve or thermostatic cartridge, which will affect the flow and sensitivity of automatic temperature adjustment. Please take out the thermostatic cartridge, and clean the cartridge strainer.
- \* To avoid damage, please remove all chrome parts before any maintenance takes place.

### Maintenance (Thermostatic Cartridge)

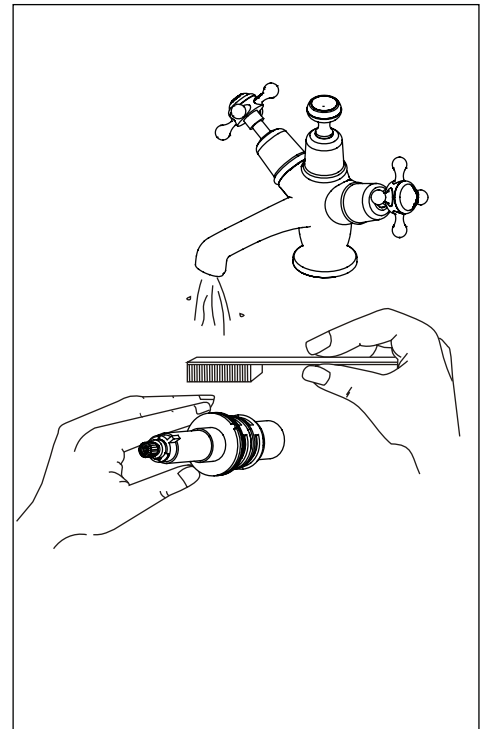
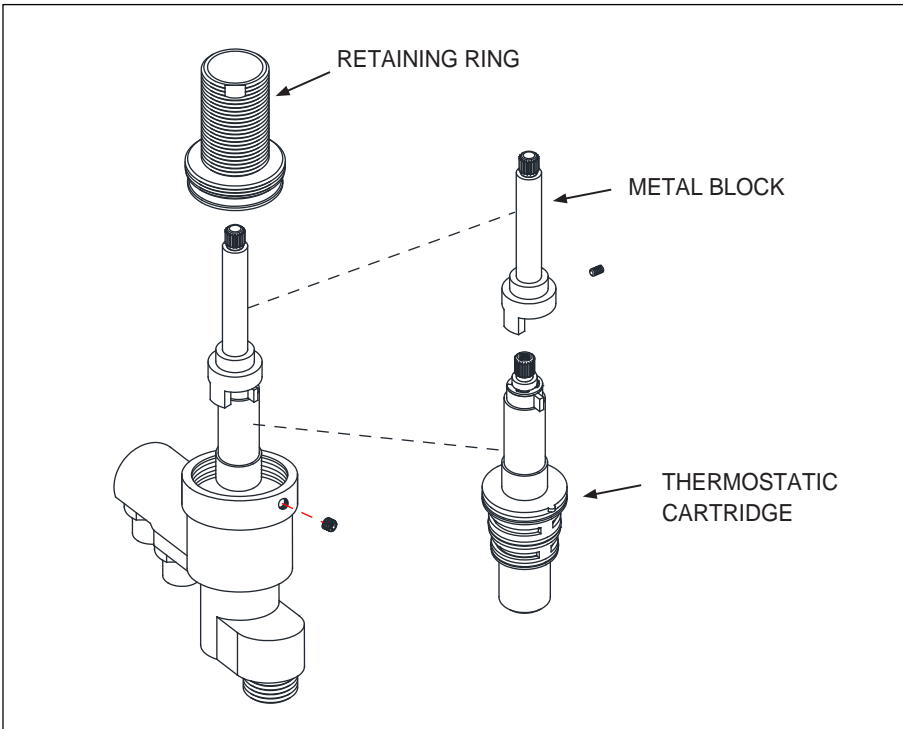

The concealed thermostatic cartridges should give trouble free service, but in the event of failure, servicing is straight forward.

- Remove the cartridge retaining ring.
- Pull out the thermostatic cartridge.
- Wash the thermostatic cartridge with clean running water, dry and lightly grease the seals (only use silicone grease).
- Put back the thermostatic cartridge (The locating lug should be sit inside the socket of housing), then tighten the retaining ring.

## **Trouble Shooting**

- Output water temperature does not correspond with temperature set  
Cause: Thermostat has not been adjusted base on the existing home water system  
Remedy: Adjust the thermostat, refer to "Temperature Setting" procedure.  
Cause: Hot Water temperature too low.  
Remedy: Adjuster the water heater, increase hot water temperature to 65°C
- Crossflow, cold water being forced into hot water pipe, or vice versa, when valve is closed  
Cause: check valves dirty or leaking  
Remedy: Clean the check valves or exchange if necessary
- Very low flow or no flow  
Cause: Supply pressure inadequate  
Remedy: Check hot and cold feeds. If a pump has been installed, please check to see if the pump is working.  
(the valve will shut down if either the cold or hot water supply fails)
- Water will not run hot enough when first installed  
Cause: Wrong maximum temperature setting  
Remedy: Adjust the maximum temperature, refer to "Temperature Setting" procedure.