

Sales Code: TWS009

Description: Non Concussive Mono Basin

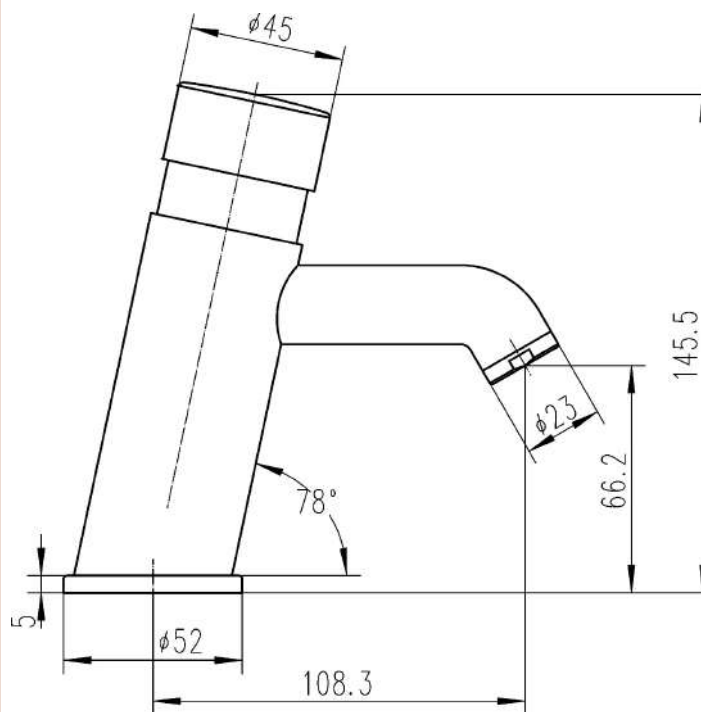

Product Dimensions

Height (mm):	146
Width (mm):	45
Depth (mm):	108
Length (mm):	
Nett Weight (kg):	1.39

Packaging Dimensions

Height (mm):	85
Width (mm):	150
Depth (mm):	200
Gross Weight (kg):	1.39

Packaging Data

Box Colour:	White Cardboard Box
Box Qty:	0
Label Size:	0 x 0
Label Colour:	White Label
Label Qty:	0

Outer Box Dimensions (If Applicable)

Height (mm):	275
Width (mm):	410
Depth (mm):	305
Length (mm):	
Gross Weight (kg):	17
Barcode:	5055369019298

Product Details

Country of Origin:	United Kingdom
Fitting Instruction:	Yes
Product Material:	Brass
Control Type:	Manual
Waste Included:	Waste Not Included
Waste Type:	Not Applicable
WRAS Approval: No	Approval No: N/A
Valve/Cartridge Type:	Non Concussive
Colour/Finish:	Chrome
Mount Type:	Deck
Operating Pressure (bar):	1
Flow Rates: (Litres Per Min)	0.1 bar: N/A 0.5 bar: 3 1 bar: 5 2 bar: 7 3 bar: 8,5
Pipe Size:	15 mm (1/2" Bsp)
Pipe Centres:	N/A