

INSTALLATION INSTRUCTIONS

Three Tap Hole tap, with pop up (excluding tap heads & base) - T14

Quarter Turn Three Tap Hole tap, with pop up (excluding tap heads & base) - T14-QT

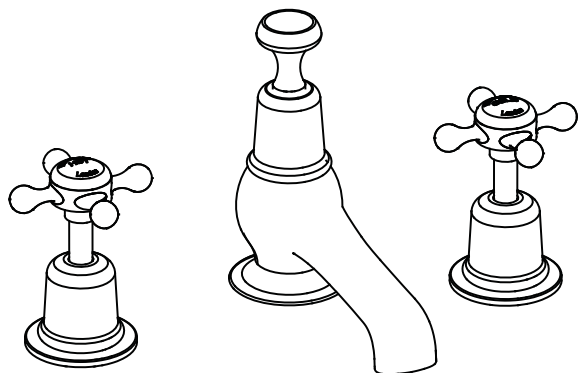

* The product in this package has no handles or bases supplied. The handles shown in the diagram are for reference only.

Option 1:
Burlington has 4 different style handle for your selection.

Claremont **Anglesey** **Birkenhead** **Kensington**
(For Quarter turn only)

Option 2:
Burlington also have a base (27mm height) for your selection.

27mm

NOT INCLUDED IN THE TAP BOX

Important

- We recommend that this product is installed by a qualified professional contractor. Such as a plumber who is certified by NVQ (National Vocational Qualification) or SNVQ (Scottish National Vocational Qualification) Level 3
- Please check this product immediately to ensure that it has not been damaged and is complete. Before installation, please make sure this product is the correct model and you have all the parts required for installation and using.
- All the taps in Burlington Range should be supplied with hot and cold water at balanced pressure. If not, then the mixing function will not work correctly. It is necessary to fit non-return valves on both hot and cold feeds pipe. These are not supplied.
- Please flush the water system to ensure that no metal swarf, solder, and other impurities can enter the taps.
- Turn off water supply before commencing work, this should be done at the isolating valves of inlet feeds if fitted or main stopcock.
- Please read these instructions carefully and keep it for future reference.

Working pressure

The tap is suitable for both high and low pressure installation. To ensure that the tap works well under low water pressure, the cold water storage tank must be at least 2 meters above the installed position. The maximum static pressure is 10 bar, and operating water pressure is 5 bar. Where the operating water pressure above 5 bar, then a pressure reducing valve must be fitted.

Straightener and aerator (alternative options)

The tap comes with a factory-fitted flow straightener for low pressure water systems. If the water flow is high, replace the factory-fitted flow straightener with the high pressure aerator supplied.

Use NEOPERL Key to unscrew the straightener in the Nozzle. Replace with the aerator provided, and screw back in nozzle tightly. (If you misplace the Neoperl key you can use the top of the aerator/straightener as a key)



FLOW STRAIGHTENER

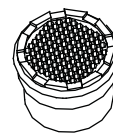

AERATOR

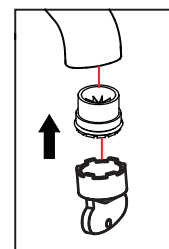
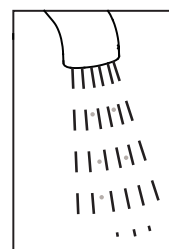
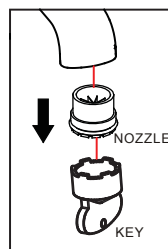

Cleaning

Before use: Unscrew the filter and allow the water to run freely for 5 minutes. Then screw the filter back in place.

Periodically: Using the key provided unscrew the nozzle and remove. Rinse it with cleaning running water until any loose debris is cleared. Then replace the nozzle and tighten with key provided.

Maintenance

We do NOT recommend you use any household cleaners to clean the product. Because these cleaners change substance or formula too frequently. The product should be always cleaned only with soapy water and rinsed with clean water and dried with a soft cloth.

Dimension

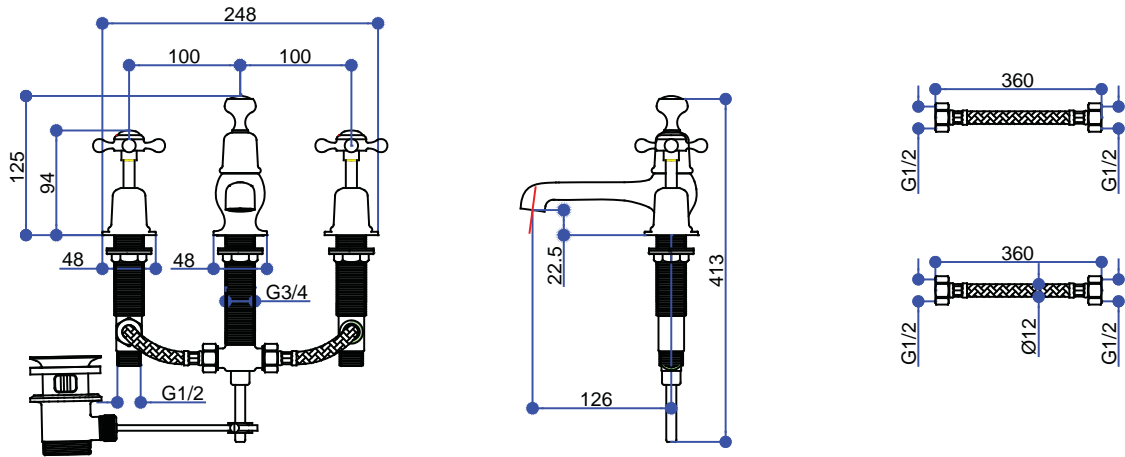

Installation

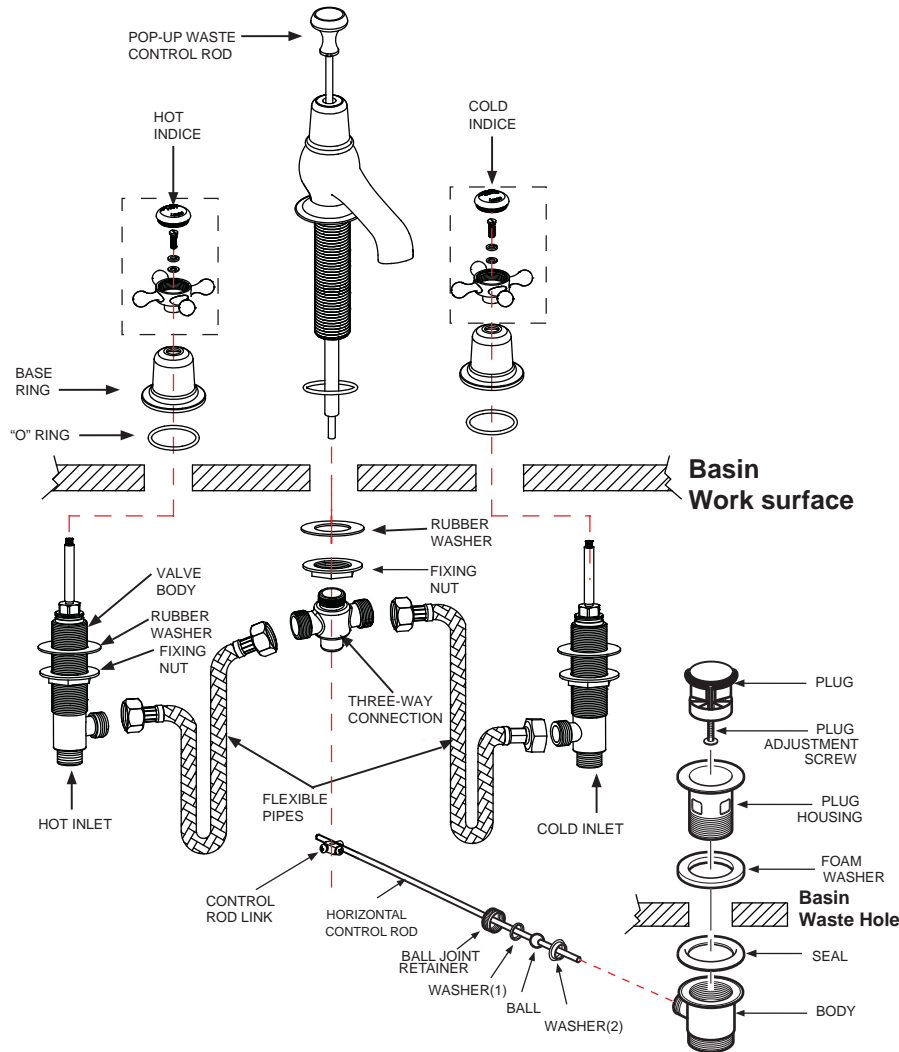

Note: To ensure the Kensington lever tap head faces in the correct forward position once installed, you may need to tighten the cartridge into the tap body a notch with a monkey spanner and then re-attach the tap head.

Operation

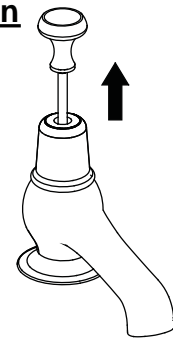

This Burlington product has a pop-up waste, that is operated by pulling up the handle on the spout body.

1. Install the Central main body part:
 - a) Fit the "O" ring into the groove on the underside of the tap main body.
 - b) Then insert the tap main body into the centre hole on the basin from above.
 - c) Tight the fixing nut and fix the main body on the basin.
 - d) Screw on the three-way connection at the tail of tap main body.
2. Install the Left and Right control valve part:
 - a) Fit the "O" ring into the groove on the underside of both tap valve cover.
 - b) Screw the rubber washer and fixing nut onto the valve .
 - c) Insert the two valve bodies into left and right hole on the basin from bottom.
 - d) Tight the valve cover and fix it together with the valve body.
3. Use two flexible pipes to connect from middle three-way connection to both left and right valve bodies.
4. Connect the water supply pipe to the tap control valve with the hot water on the left and cold water on the right. (Viewer from the front.)
5. Install Pop-Up Waste:
 - a) Insert the Pop-Up control rod into the tap main body .
 - b) Insert the pop up waste on the basin and tighten.
 - c) Insert the horizontal control rod into the waste, and tight the ball joint retainer to make sure the ball with two washers on bath sides are fix with the waste.
 - d) Connect the pop-up control rod with the horizontal control rod.
 - e) Test the pop-up waste function, adjust the connection between pop-up control rod and horizontal control rod , or the ball joint retainer if necessary.