

Sales Code: VSQ3

Description: Concealed Sequential Thermo Valve

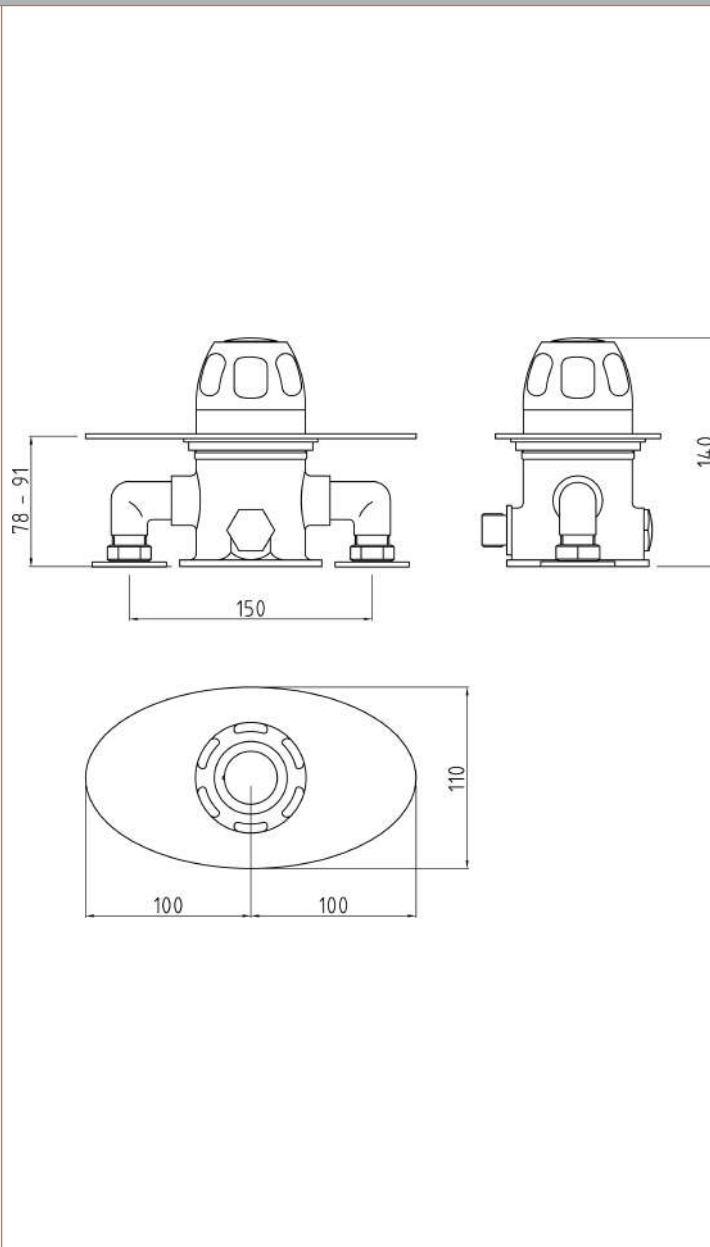

Product Dimensions	
Length (mm):	
Width (mm):	200
Height (mm):	110
Depth (mm):	140
Nett Weight (kg):	3.09
Packaging Dimensions	
Length (mm):	240
Width (mm):	201
Height (mm):	170
Gross Weight (kg):	3.09
Packaging Data	
Box Colour:	White Cardboard Box
Box Qty:	0
Label Size:	0 x 0
Label Colour:	White Label
Label Qty:	0
Outer Box Dimensions (If Applicable)	
Length (mm):	
Width (mm):	500
Height (mm):	370
Depth (mm):	445
Gross Weight (kg):	
Barcode:	5055275826737
Product Details	
Country of Origin:	United Kingdom
Fitting Instruction:	Yes
Product Material:	Brass
Mount Type:	Wall
Outlet Elbow Supplied:	Not Applicable
Easy Clean:	Not Applicable
Head Included:	No
Handset Included:	No
Body Jets Included:	Not Applicable
No of Body Jets:	Not Applicable
Operating Pressure (bar):	0.2
Valve/Cartridge Type:	Sequential Valve
Flow Rates (L/min):	0.1 bar: 4 0.5 bar: 9.5 1 bar: 15 2 bar: 22 3 bar: 27
TMV2 Approved:	No Approval No: N/A
TMV3 Approved:	No Approval No: N/A
WRAS Approved:	No Approval No: N/A
Head Function:	Not Applicable
Handset Function:	Not Applicable
Body Jet Info:	Not Applicable
Pipe Size:	15 mm (1/2" Bsp)
Pipe Centres:	147mm
Colour/Finish:	Chrome
Hose Included:	Not Applicable
No. of Outlets:	1