

Pivot Door

INSTALLATION INSTRUCTIONS

www.aquadart.co.uk

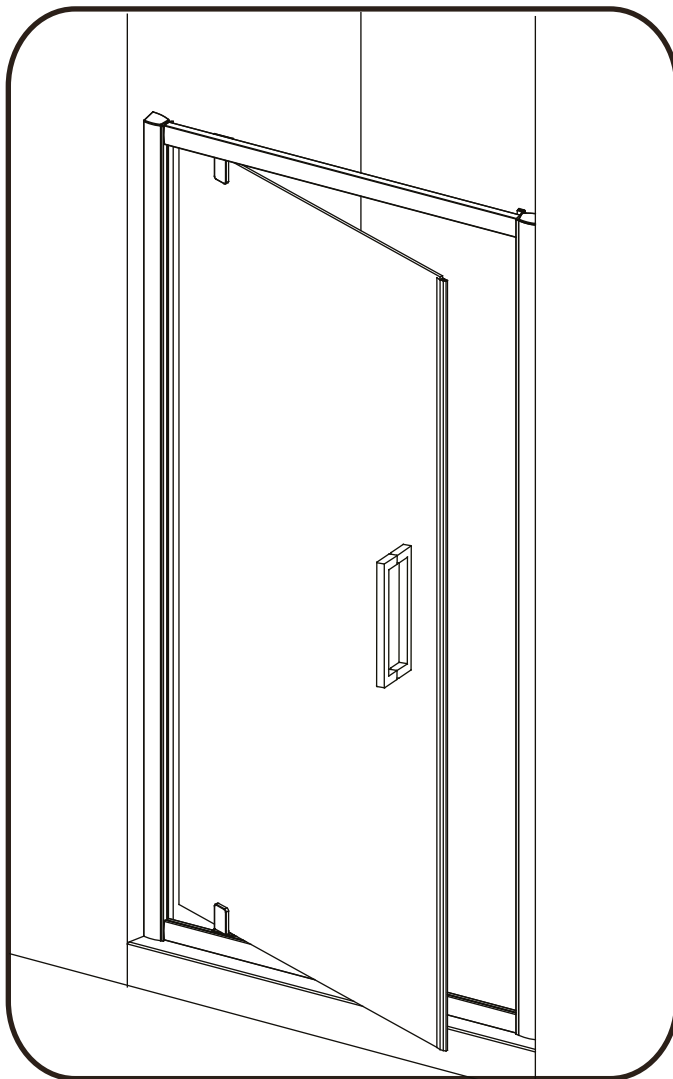

Tools Required



Drill

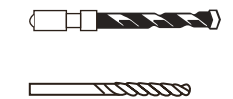

**6mm Masonry Drill
2.75mm HSS Drill**

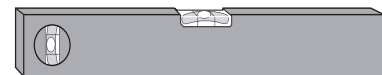

Spirit level



Sealant Gun

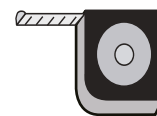

Tape Measure



Pencil



**PH2 TYPE
Screwdriver**

Please note hand tools **NOT** supplied.

IMPORTANT

This product should be installed by a suitably qualified and proficient person. The fitting instructions should be followed carefully to ensure a proper and safe installation. Failure to follow these instructions could result in future injury.

These instructions and list of parts assume that installation is done against solid/tiled walls.

Please check this product for damage prior to starting the installation. No claims can be made after the product has been fitted.

PLEASE NOTE :The minimum and maximum adjustment sizes noted on the product brochures are based on perfectly plumb walls and trays.

USE SAFETY EYE-WEAR WHEN DRILLING

COMPONENTS AND BOX CONTENTS

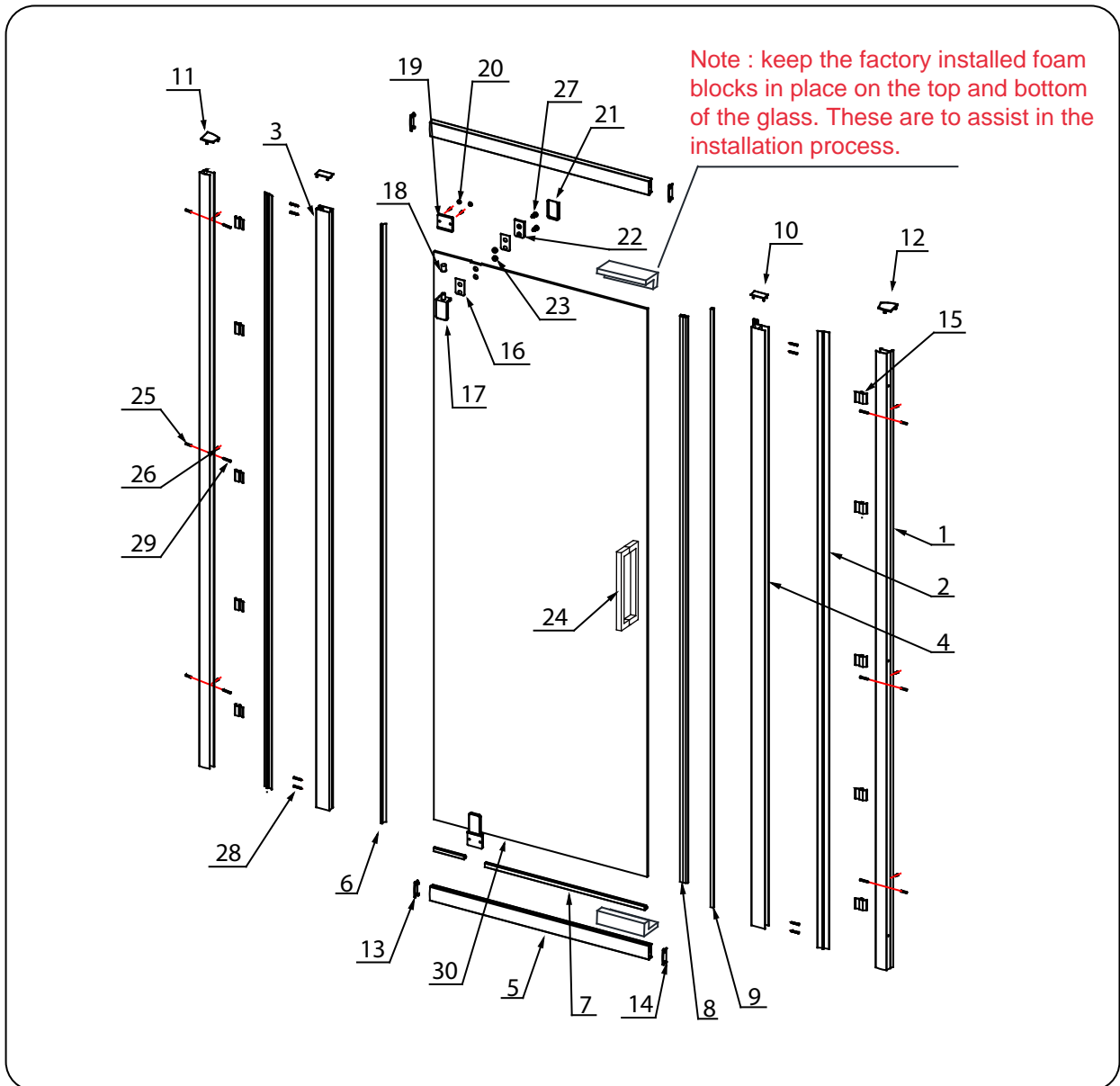

Box Contents

NO	Description	Qty	NO	Description	Qty
1	Wall Profile	2	16	Washer	4
2	Cover Profile	2	17	Pivot Core	2
3	Upright Profile	1	18	Pivot Gasket	2
4	Magnetic Profile	1	19	Fixing For Pivot	2
5	Horizontal Profile	2	20	Cover Cap	4
6	Upright Seal	1	21	Pivot Back Cap	2
7	Horizontal Seal	1	22	Pivot Clamping	2
8	Magnetic Seal	1	23	Round Washer	4
9	Frame Seal	1	24	Handle	1
10	Upright Profile Cap	2	25	Wall Plug	6
11	Wall Profile Cap-L	1	26	Screw ST3.5x10	10
12	Wall Profile Cap-R	1	27	Screw M5x12	4
13	Horizontal Profile Cap-L	2	28	Screw ST3.5x40	8
14	Horizontal Profile Cap-R	2	29	Screw ST4x45	6
15	Profile Clip	10	30	Moving Glass Panel	1





FIXING KIT COMPONENTS, SITE CONDITIONS

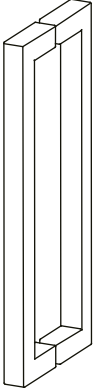



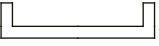

FIXING KIT









Venturi 8 Handle



Handle x 1

	Handle inside part x 1
	Handle outside part x 1
	Washer x 4
	Round head screw x 2 M5x24
	Screw nut x 2pcs
	Jackscrew x 2 M4x8

		
Wall Plug 6 pcs	Round Head Tapping Screw 4 x 45 6 pcs	Round Head Tapping Screw 3.5 x 10 6 pcs
		
Wall Profile Top Cover Cap x 2	Upright Profile Top Cover Cap x 2	Horizontal Profile Cap x 2

			
Pivot Clamping x2	Glass Gasket x4	Fixing For Pivot x2	Pivot Core x2
			
Cover Cap x2	Pivot Back Cap x2	Pivot Gasket x2	Profile Clip x10

IMPORTANT - Missing Components

Please check this product for missing components prior to installation.

For spare parts visit www.aquadart.co.uk

IMPORTANT - Installation site

1. Ensure the top surface of the shower tray on which the enclosure will be installed is level in every direction.
2. The tiles or other wall finishing should be effectively sealed at tray edges.
3. Tiles should extend at least to the corner of the tray and a minimum of 1.9 meters from the top of the tray.

PROCEDURE

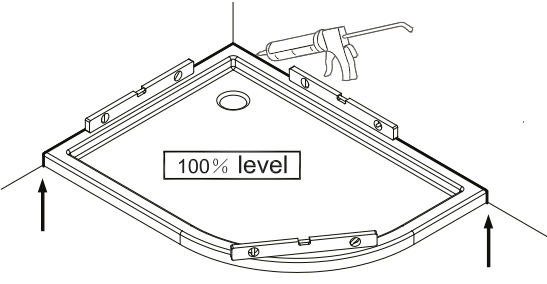

TRAY MUST BE 100% LEVEL IN ALL DIRECTIONS

Ensure the shower tray is level in all directions and is properly sealed to the wall. The wall must be tiled down to the top edge of the tray. **Do not angle out bottom tile.**

TRAY MUST BE SEALED FULLY AROUND WHERE THE TRAY MEETS THE WALL.

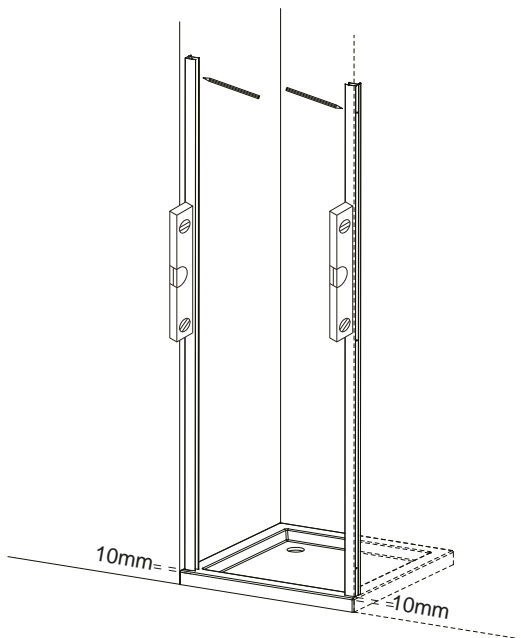

Step 1.1 & 1.2

Step 1.

1.1 Position the wall profiles to wall as shown (roughly 10mm from the front of the tray).

1.2 Level the frame using a spirit level.

1.3 Once you are happy that the frame sits on the tray correctly mark the wall through the 3 pre-drilled screw holes in the wall profiles.

NOTE: You may find it easier to mark and drill the wall if you apply masking tape to it first.

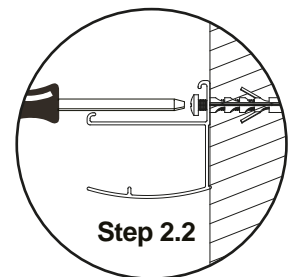
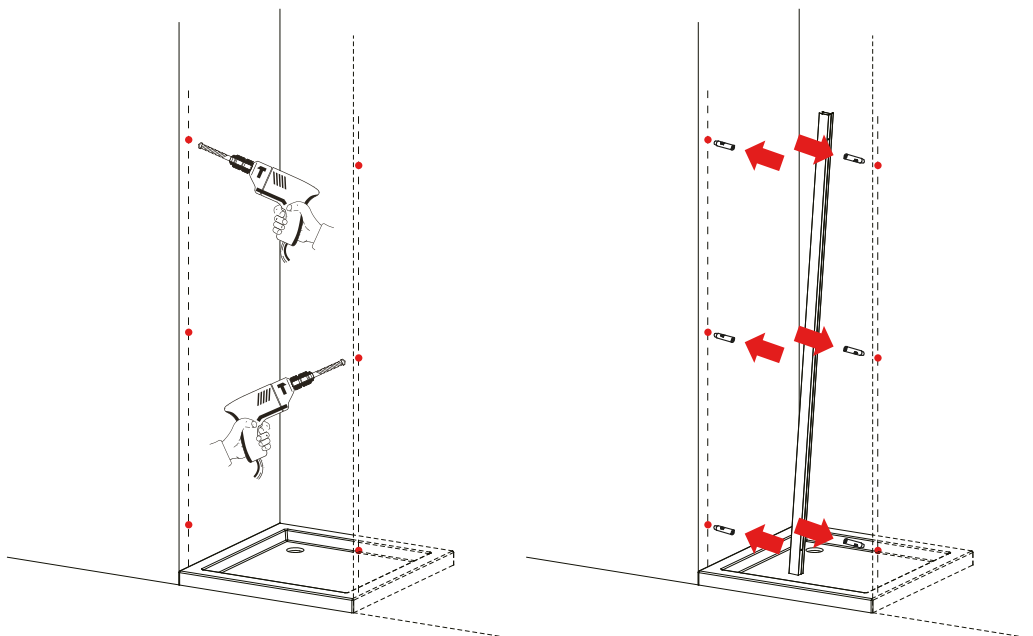

Step 2.1

Step 2.

2.1 Remove the wall profiles and drill the marked points using a 6mm masonry drill bit, once this is done insert 6 x wall plugs .

2.2 Fix the wall profile to wall using the screws ST4 x 40 .

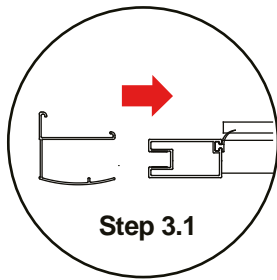

Step 3.1

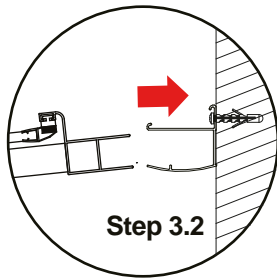

Step 3.2

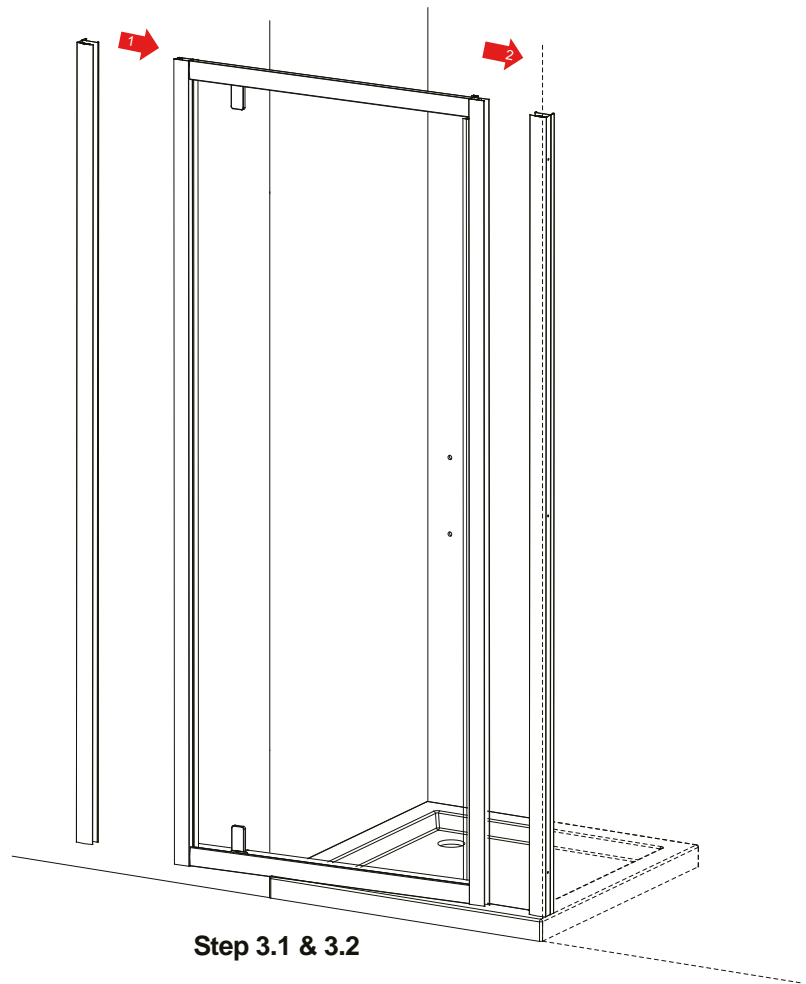

Step 3.1 & 3.2

Step 3.

3.1 Push the other wall profile to the hinged side.

3.2 Then insert the frame into the fixed wall profile as shown.

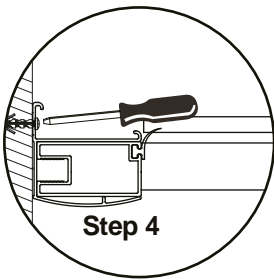

Step 4

Step 4.

Fix the other wall profile using screws ST4 x 40.

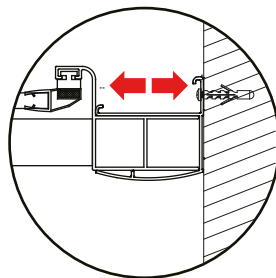
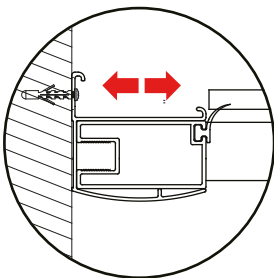

Step 5

Step 5.

Adjust the frame to ensure that it is central between the wall profiles and level against the shower tray at the base.

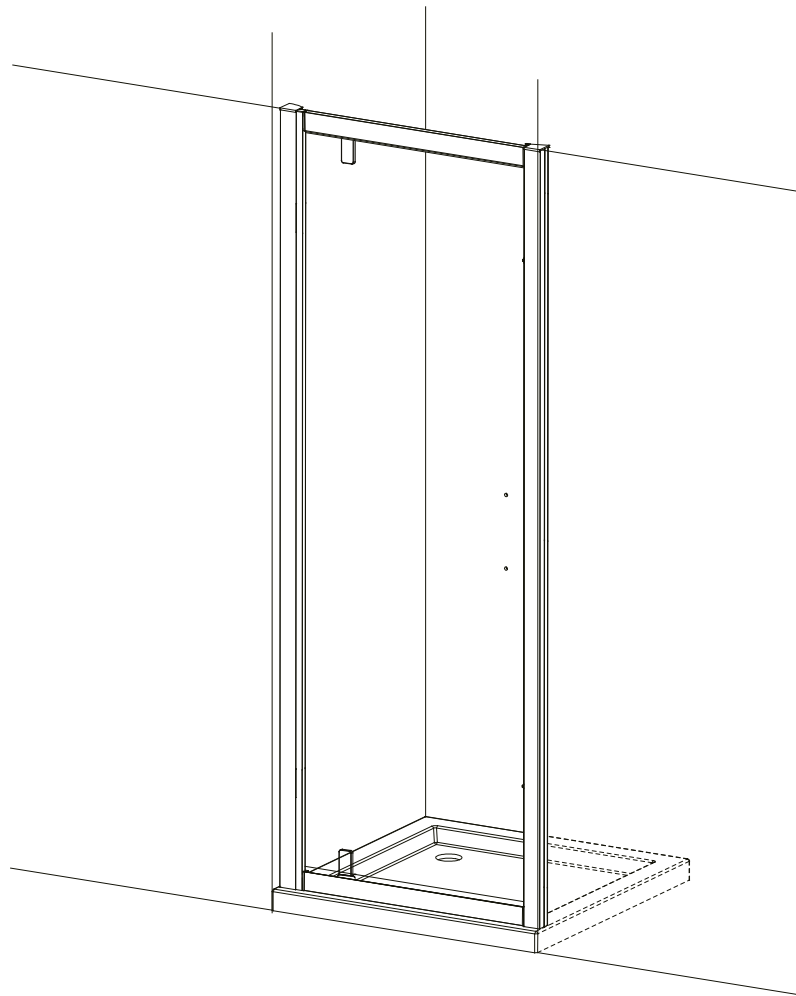
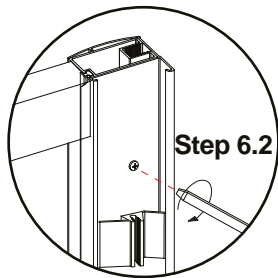
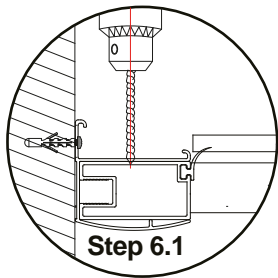

Step 6.

6.1 Drill 4 equally spaced holes with a 2.75mm drill bit through the wall profiles and frame.

6.2 Fix the frame to the wall profiles using the screws ST3.5 x 10 .

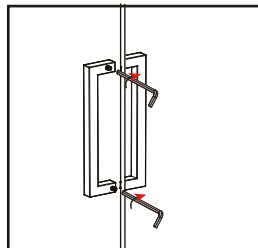
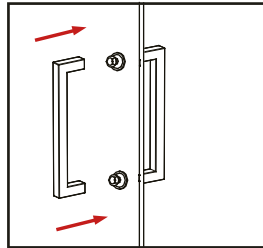
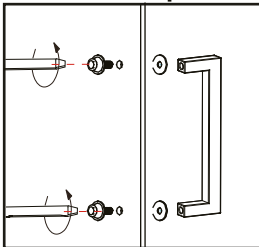

Step 7.

Fix the handle to door panel.

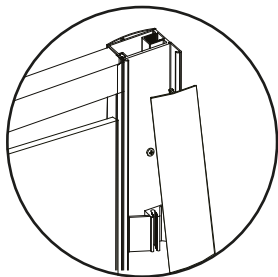

Step 8

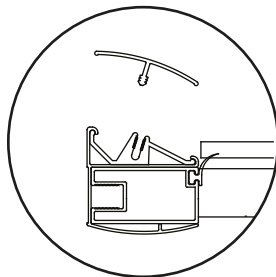

Step 8.

Once you are happy that the installation is correct, push the cover strip profile into the nylon clips as shown.

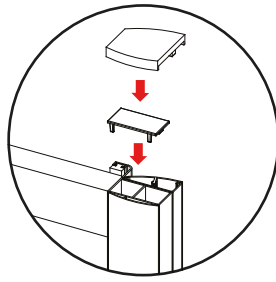
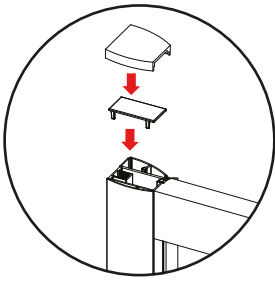

Step 9

Step 9.

Fit the upright profile top caps and wall profiles top caps as shown.

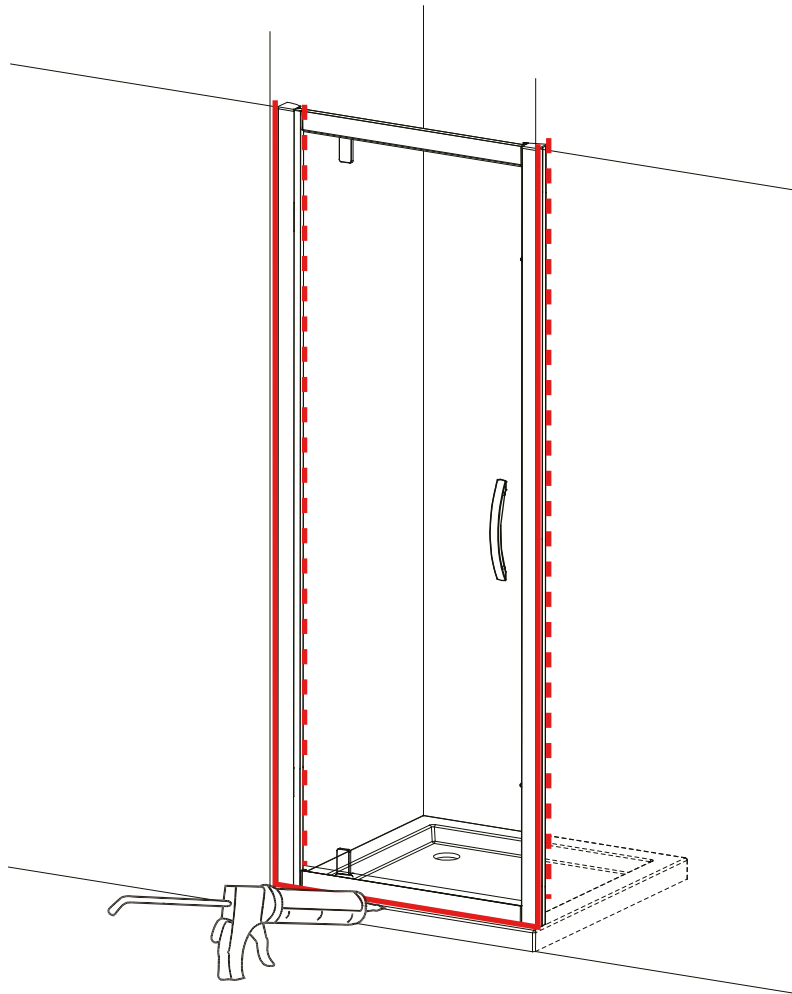

24 HRS

DO NOT USE THE ENCLOSURE FOR 24 HOURS AFTER SEALING

Applying Silicone Sealant

Sealing Inside

Seal from the top of the wall profile to the bottom on the **INSIDE** between the wall profile and the wall.

IMPORTANT: Do not apply sealant on inside of the tray.

Sealing Outside

Seal from the top of the wall profile to the bottom between the wall profile and tiles on both sides. Also seal along the bottom where the frame meets the tray. Seal the joints between the bottom profile and any upright profiles.

AFTERCARE

Cleaning Instructions

It is important to clean your Aquadart shower enclosure after every use. Please wipe down all glass and metal parts with a clean soft cloth. Ensure that all residual water on the glass is removed after every use.

Usage

For reliable, watertight performance from your Aquadart enclosure your shower head should not be positioned so that the shower sprays directly onto the enclosure door. Failure to comply with this may cause the shower to leak. Outward opening doors may cause water to drip onto the floor, please ensure that the floor covering immediately outside the enclosure will not be affected by water.

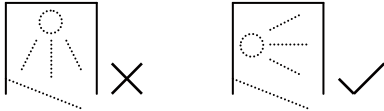

This product has been treated with Clean & Clear™ easy clean glass treatment, a protective barrier which creates a 'non-stick' surface on your glass, helping to resist lime scale build up and water spots. For further information on Clean & Clear™ please visit www.aquadart.co.uk

Aftercare

Clean & Clear™ glass can be cleaned with any suitable nonabrasive glass cleaner - with PH value of between 3-11; the coating will not be damaged. Avoid surfactants and heavily perfumed products. Vinegar and water based products are very effective. Do not use abrasive scrubbing cleaners or equipment for cleaning.

Warranty

Limited 5 year Warranty for Clean & Clear™ treatment: To guarantee treated surfaces will remain more repellent than untreated glass for 5 years from start of use, as long as basic manufacturer maintenance recommendations are followed and no harsh or abrasive cleaners are used.

AQUADART

Riverside Business Park, Royd Ings Avenue, Keighley, West Yorkshire, BD21 4AF
For technical / aftersales queries, please visit our website : www.aquadart.co.uk
or Sales Tel : 01535 613830 Technical: 01535 613830 Fax: 01535 613831

