

Installation Instructions

Panel Riser Kit

Option 1

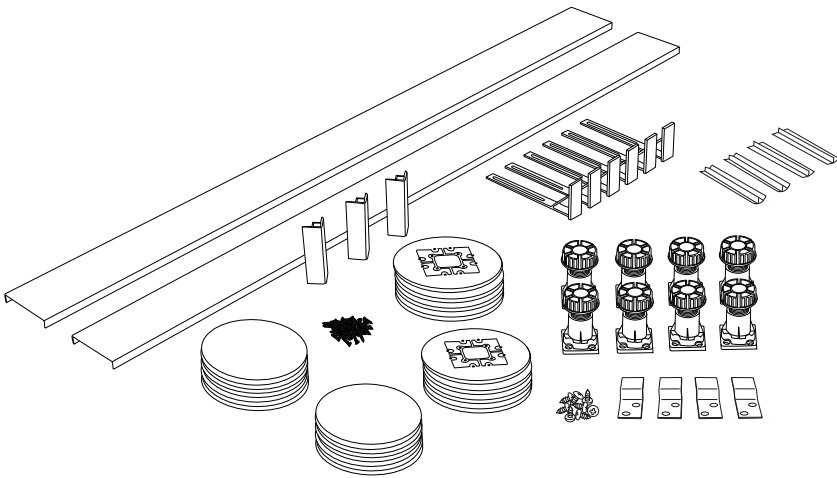

Before you Start



Please read these instructions fully before starting. Although these instructions are comprehensive we always recommend that a technically competent installer undertake the installation.

Your Panel Riser Kit (Option 1) is intended as a basic general purpose raised installation kit and may fit a number of different shower tray sizes, squares, rectangles and pentangles up to 1200mm, as a consequence the instructions **MUST** be read in conjunction with any and all instructions supplied with your chosen shower tray.

Note! This kit cannot be used on quadrant trays. If in doubt on the suitability of this kit for your chosen shower tray, please contact your supplier who will be able to help you.

For shower trays with one or more dimensions longer than 1200mm and up to 2000mm in length an option 2 panel kit is required.



Important

Before you start, check the pack and ensure that you have all of the parts listed. If there is a problem please contact your supplier.

Make sure that you have the right tools and materials to hand with plenty of space and a clean dry area for assembly.

When handling your shower tray take care not to damage the bottom edges and when installing take particular care to protect the visible surfaces from impact damage or abrasions.



Safety Notes

Caution: Care must be taken when drilling into walls or floors to avoid hidden pipes or electrical cables.



Technical Help

Technical Service Line: 0845 505 2211 / 01684 293311 Open Mon–Fri 9am–5pm

We reserve the right to change specifications or withdraw products from these instructions without prior notice.



Dimensions are nominal and shown in millimetres unless otherwise stated.

Parts Supplied

A



Qty 2

1225mm Straight Panels

B



Qty 8

C



Qty 8

Leg Mounting Brackets (Ref B)
Threaded Leg Tubes (Ref C)

D

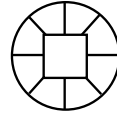

Qty 8

E



Qty 44

Circular Base Plates (Ref D)
Leg and Panel Screws (Ref E)

F

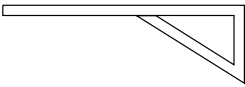

Qty 6

G

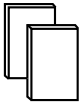

Qty 6

Panel Upright Brackets (Ref F)
Hook and Loop Pads (Ref G)

H

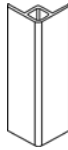

Qty 3

I



Qty 2

Corner/End Brackets (Ref H)
Quad Joining Brackets * (Ref I)

J



Qty 2

K

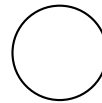

Qty 8

Pentangle Brackets (Ref J)
Circular Adhesive Pads (Ref K)

L

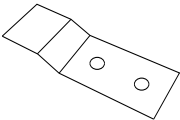

Qty 4

Floor Brackets

M



Qty 8

Floor Bracket Screws

When using a Baseboard Accessory Kit
items **D** and **K** are not required

* not required in Option 1

Tools and Materials Required (not supplied)

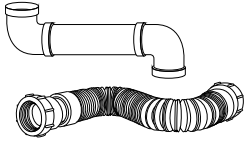

Plumbing Pipe and Fittings

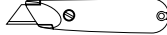

Sharp Knife



Safety Eyewear



Spirit Level



Pencil

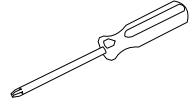

Screwdriver

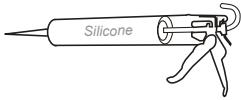

Silicone Sealant

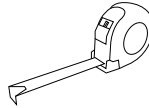

Tape Measure

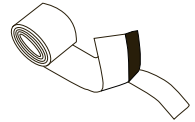

Flexi Seal Strip

Note! Other tools and materials may be needed depending on the specific site requirements.

Installation

1 Area Preparation

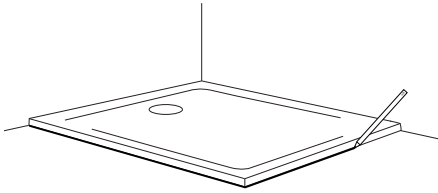

Place the shower tray in position on the floor and mark the waste position and the perimeter of the tray on the floor.

Note! Any floor area under the tray MUST be rigid and level.

2

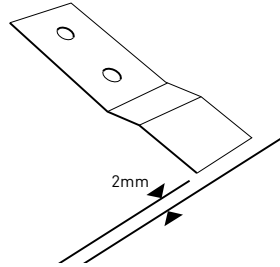

Remove the shower tray and screw the Floor Brackets ① using screws ② to the floor with the open end of the bracket 2mm back from the marked line, evenly spaced, parallel with the sides adjacent the intended panel access sides.

Adjust the open end of the Floor Brackets ① to accept the bottom edge of the panels ③ nominally 1.5mm

Note! On concrete floors, discard screws ② supplied, alternative fixings (not supplied) will be required.

3

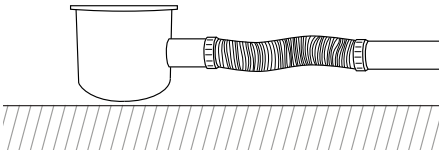

Install pipework to the area (not supplied) in accordance with the building regulations and attach the Waste Outlet (not supplied).

4 Leg Assembly

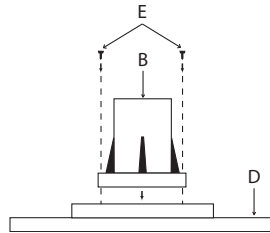

Screw all the Leg Mounting Brackets ③ to the upper face of the Circular Base Plates ④ using screws ⑤.

Note! If using a Baseboard Accessory Kit, do not assemble item ③ onto ④

Installation

5

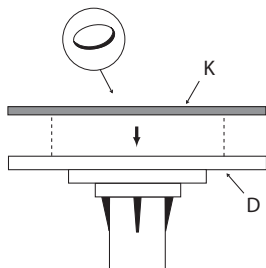

Attach the Circular Adhesive Pads **K** to the under-side of all the Circular Base Plates **D** by removing the backing paper from one side **ONLY** of the Adhesive Pads **K**, centralise and push firmly into position.

7

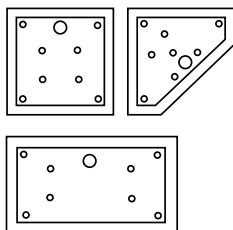

With your shower tray upside down, position all (**DO NOT PERMANENTLY FIX AT THIS STAGE**) the leg assemblies to form an evenly supported structure. Wherever possible use the full number of leg assemblies available for maximum support.

Note! On some types of thin plastic shower trays, these will require the use of the Baseboard Accessory Kit in addition to this kit.

6 Leg Positioning

Shower tray types can have numerous styles of finish on the underside ranging from cast pre-designated leg positions (circles on the base corresponding with leg pieces), flat with a periphery gully or a completely flat plastic finish. Consequently this section is intended as general guidance.

Note! Shower trays with one or more dimensions longer than 1200mm and up to 2000mm in length MUST use an option 2 kit with additional items supplied, with a longer panel and four additional legs.

Note! On smaller shower trays with pre-designated leg positions all legs may not be required.

8

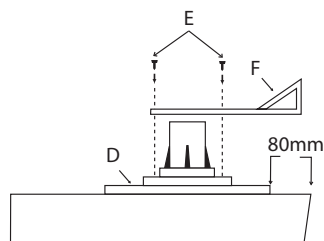

Attach the Panel Upright Brackets **F** using two screws **B** to the Circular Base Plate assemblies **D** that are located on the panel access sides of the tray.

Ensure the Panel Upright Brackets **F** are attached in-line with the panel sides with the edge of the leg assembly **D** no greater than 80mm from the edge of the tray.

Do not use brackets **F** on leg assemblies positioned away from the panel edge.

Note! If using a Baseboard Accessory Kit, affix item **F directly to boards using screws **B**.**

Installation

9

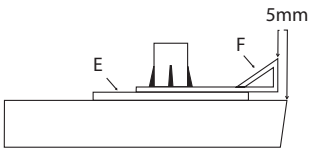

Once an evenly supported layout plan has been achieved, ensure the base of the tray is clean and free from dust and other contaminants, then remove the remaining backing paper from the Adhesive Pads **K** on the leg assemblies **D** and attach all the assemblies permanently into position.

Note! If using a Baseboard Accessory Kit, affix item **E directly to the boards using screws **G**.**

10

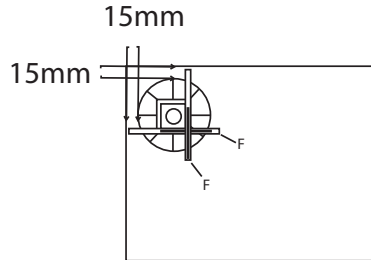

Adjust the Panel Upright Brackets **F** to achieve a nominal 15mm gap between the bracket and the tray edge. On corners the Panel Upright Brackets **F** can be overlapped at the rear if a closer fit to the edge of the tray (minimum 15mm) is required.

11

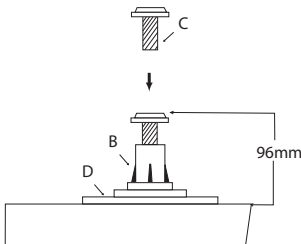

Screw all the Threaded Leg Tubes **C** into the Leg Mounting Brackets **B** on the assemblies **D** to achieve a nominal 96mm from the bottom edge of the shower tray to the base of Threaded Leg Tubes **C**.

12

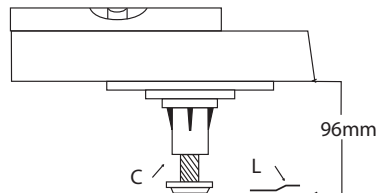

Place the shower tray upright and level into position, adjusting the Threaded Leg Tubes **C** as required maintaining a gap not less than 96mm between the bottom edge of tray and the floor.

Installation

13

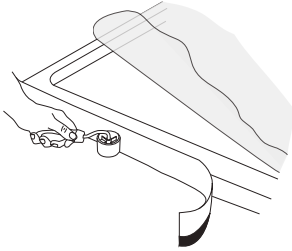

Note! Some shower trays have a protective film (indicated by a label on the surface) which must now be removed. Undertake a final inspection of the shower tray at this stage. DO NOT PROCEED IF NOT SATISFIED.

If fitting the optional (not supplied) Flexi Seal Strip, (Flat top shower trays only) follow the instructions supplied with this item at this stage.

14

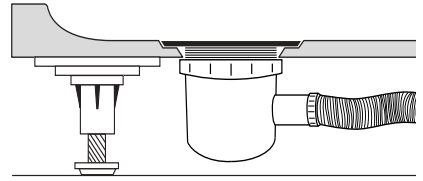

Attach the Waste Outlet to the shower tray using silicone between all mating surfaces. The shower tray and all connections **MUST** now be checked for water tightness flow and adequate drainage over the entire area. **DO NOT PROCEED IF NOT SATISFIED.**

Note! You MUST check that all the legs are fully in contact with a rigid floor at this stage. DO NOT PROCEED IF LEGS ARE NOT CORRECT.

15 Panel Trimming and Assembly

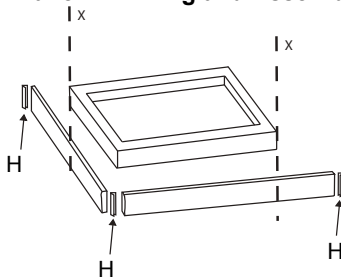

Square and rectangle trays:

Cut panels **A** to the size required and join panels by removing the coloured adhesive backing paper from the Corner/End Brackets **B** and attach.

Attach the remaining Corner End Brackets **B** by removing the coloured adhesive backing paper and attach to the ends of panels as required.

16

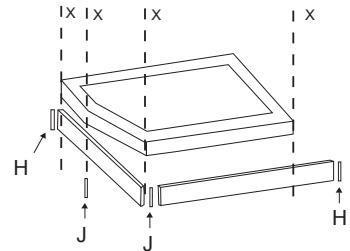

Pentangle trays:

Cut / mitre the panels **A** to fit the shower tray and join by removing the coloured adhesive backing paper from the Pentangle Joining Brackets **B** and attach.

Attach the remaining Corner End Brackets **B** by removing the coloured adhesive backing paper and attach to the ends of panels as required.

Installation

17 Panel Installation

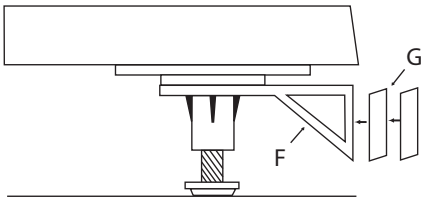

Using Adhesive Hook & Loop Pads **G** remove the self-adhesive backing paper from one side **ONLY** and attach to the ends of the Panel Upright Brackets **F**.

Test fit assembled panels by sliding into Floor Brackets **L** before final assembly and ensure correct orientation to fit as required. **DO NOT PROCEED IF NOT SATISFIED.**

18

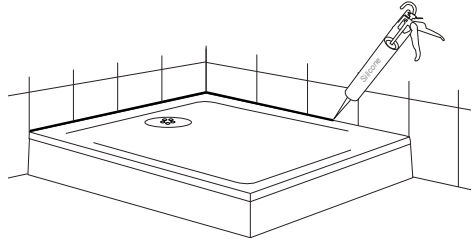

Remove the remaining backing papers from the Adhesive Hook & Loop Pads **G** attached to the Panel Upright Brackets **F** and push the panel assembly firmly into position.

Note! Once the panel assembly is correctly in place it MUST be sealed along the joining edge if using only the Floor Brackets **L to hold the panels in-situ.**

After all checks and adjustments, seal along the edge of the tray using silicone if not using a Flexi Seal Strip.

Installation – Flexi Seal Strip

This optional item (not supplied) is intended as a flexible tiling upstand and should be fitted to the side of the tray adjacent the walls only.

1

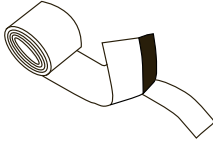

Wipe the surfaces clean where the strip will be attached first with a clean damp cloth, allow to dry and then wipe with the IPA wipe supplied in the kit.

Determine the length of strip required to seal around the shower tray and cut to length with scissors. (Ensure you cut at least 20mm longer than needed).

Peel back approximately 20cm of backing from the adhesive strip.

2

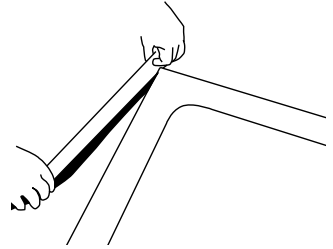

Attach to the edge of the shower tray so that it is square and the edge protrudes at least 20mm above the edge of the tray.

Make sure the adhesive strip is positioned so that it will not come into contact with any silicone sealer used later.

Note! If applying to a cut or trimmed tray, ensure that the adhesive edge follows the top edge of the tray and any material below the base of the tray should be removed with a sharp knife.

3

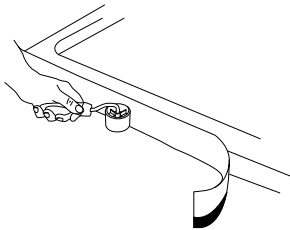

Using a small roller or other appropriate tool roll the seal strip so that it attaches firmly to the edge of the tray removing any bubbles or creases, paying particular attention to the corners.

Gradually remove the cover strip in sections and roll on the seal so it attaches firmly and square to the edge of the tray, making sure there are no gaps between tray and seal strip. Trim off any excess strip.

4

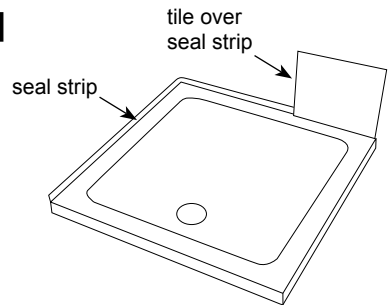

Install the shower tray in the correct position and tile in front of the seal strip.

Put a protective bead of silicone or other suitable flexible sealant between the tray and the tile, ensuring it does not come into contact with the adhesive material on the flexi seal strip.



- Q I am not sure if this is the correct kit for my shower tray.**
- A** Contact your supplier of the shower tray who will be able to assist you.
- Q I have a Gel Coated Stone Resin type shower tray and the instructions state it **MUST** be installed on sand and cement only, can an easy plumb kit be used?**
- A** Yes an Panel Riser Kit can be used but contact your supplier as an Baseboard Accessory Pack **MUST** be used for this type of shower tray in addition to this kit.
- Q Can I lower or raise the legs to give a gap smaller or bigger than 96mm under the shower tray.**
- A** The legs can be adjusted nominally from 75mm to 113mm. However, the panels are 95mm high without using an alternative and the waste unit requires a minimum gap of 80mm to fit without reassessing into the floor.
- Q Can I remove the panels at a later date?**
- A** Yes the panel assembly is designed to enable ease of removal to inspect the plumbing or to adjust the feet if required.
- Q The shower tray itself feels flexible when installed in a raised option.**
- A** This is not a problem in itself. However, you **MUST** use a Baseboard Accessory Kit in addition to this kit.
- Q The installed shower tray assembly feels loose.**
- A** Check that floor under the tray is rigid and level, also check that you have installed all the available legs forming an evenly supported structure and that all the legs are fully in contact with the floor.

Product supplied by the MX Group and/or its subsidiaries

Technical Service Line: **0845 505 2211 / 01684 293311** Open Mon–Fri 9am–5pm