

YOUNG A

Corner entry shower enclosure, 2 hinged doors + 2 fixed panels

IMPORTANT TO BUILD UP A COMPLETE CORNER ENTRY, ORDER 2 INDIVIDUAL SIDES

Measurements (cm)		Access	Projection	Code	Glass 6mm			Profile Type Price per side		
Shower enclosure adjustability	From the finished tiled wall to the external edge of the shower tray				1	2	4	B	K	O
A	F	*			Clear	Aqua	Satin	Silver	Chrome	Gold
57 ↔ 59	58 ↔ 60	26,5	37	27	Y2A57L-					
59 ↔ 61	60 ↔ 62	26,5	39	29	Y2A59L-					
61 ↔ 63	62 ↔ 64	26,5	42	31	Y2A61L-					
65 ↔ 67	66 ↔ 68	26,5	48	35	Y2A65L-					
67 ↔ 69	68 ↔ 70	26,5	51	37	Y2A67L-					
69 ↔ 71	70 ↔ 72	26,5	54	39	Y2A69L-					
73 ↔ 75	74 ↔ 76	34,5	49	35	Y2A73L-					
75 ↔ 77	76 ↔ 78	34,5	51	37	Y2A75L-					
77 ↔ 79	78 ↔ 80	34,5	54	39	Y2A77L-					
79 ↔ 81	80 ↔ 82	34,5	57	41	Y2A79L-					
85 ↔ 87	86 ↔ 88	42,5	54	39	Y2A85L-					
87 ↔ 89	88 ↔ 90	42,5	57	41	Y2A87L-					
89 ↔ 91	90 ↔ 92	42,5	60	43	Y2A89L-					
95 ↔ 97	96 ↔ 98	42,5	69	49	Y2A95L-					
97 ↔ 99	98 ↔ 100	42,5	72	51	Y2A97L-					
99 ↔ 101	100 ↔ 102	42,5	75	53	Y2A99L-					
H 140 ↓ 200					SPECIAL					
L 57 ↔ 99					Y2ALSP					

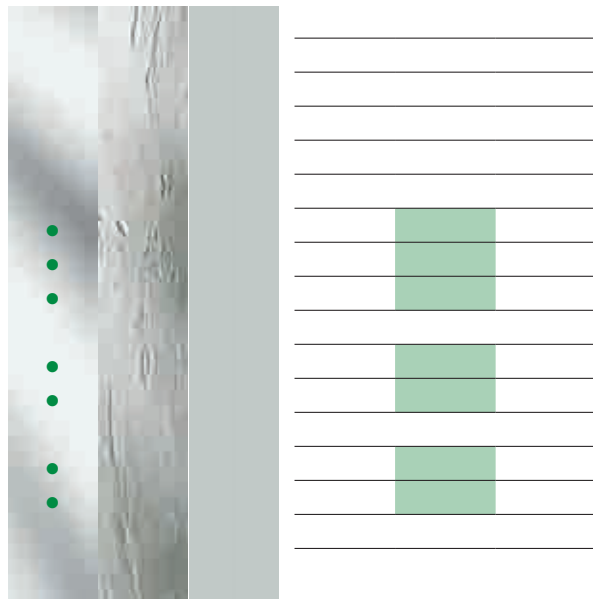

How to choose your product using the codes:

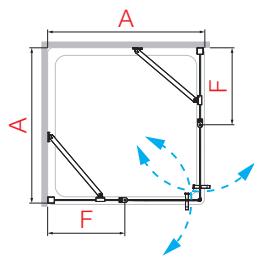
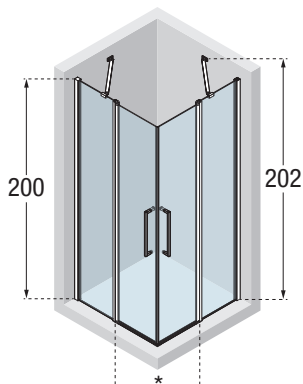

Reversible

How to take the measurement see page 61

● IN STOCK UK
(Other products) please check availability

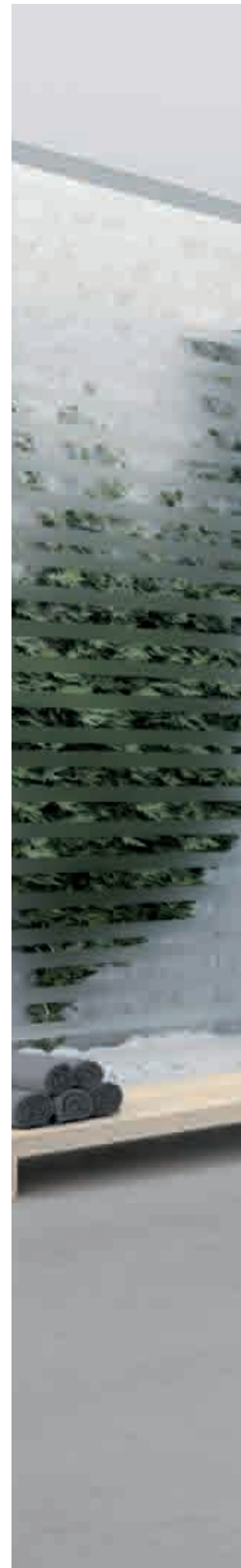



**CRYSTAL
CLEAR**
TREATMENT

**NewChrome**

TECHNICAL DATA

GLASS TYPES (European standards UNI EN 14428)

PRINTING



Clear



Aqua



Satin

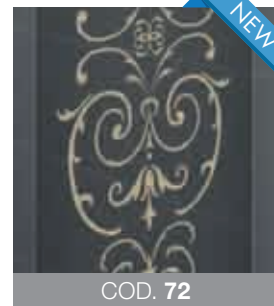

Victoriana Gold
(only for 2G, G+F, 1B, R2 LUX)

PROFILE COLOURS



Silver



Chrome



Gold
(only for 2G, G+F, 2A, G+F in line,
1B, F1B, A, R, R2, R1 SWIM, R2 LUX)

* Gold Victoriana can be selected only with gold profile

OPTIONAL



support bar

Measurements	Code	Prix
15 cm	R80LOU150-K	
25 cm	R80LOU250-K	
35 cm	R80LOU350-K	
45 cm	R80LOU450-K	



150cm support bar

Finition	Code	Prix
Silver	R80Y215-B	
Chrome	R80Y215-K	
Gold	R80Y215-O	

HOW TO TAKE THE MEASUREMENT

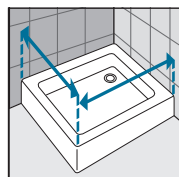
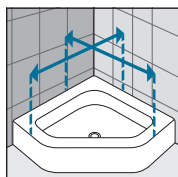
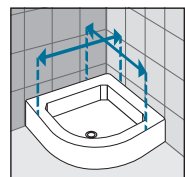

Take the measurements from wall to the external edge of the shower tray. Measurements must be taken once the walls are finished and tiled, according to the above drawings.

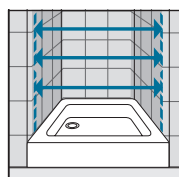

Take the measurements from wall to wall at the bottom, at the top, in the middle and use the smallest. Measurements must be taken once the walls are finished and tiled, according to the above drawings.