

# BRISTAN

## Installation Instructions & User Guide

Please leave these instructions with the end user

Product Code: CE SNK C (D1)

### Specifications

#### Inlet Water Temperature

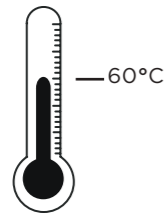

Maximum 60°C Recommended

#### Dynamic Water Pressure

Min: 0.5 bar

Max: 5.0 bar

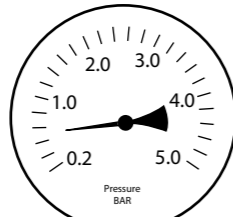

Maximum Static Pressure: 10.0 bar

#### Inlet Connections

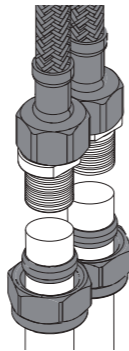

1/2" BSP Flexible Tails

\* Connection adaptors not included

### Tools You'll Need



Flat Head Screwdriver



Crosshead Screwdriver

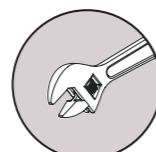

Adjustable Spanner

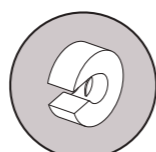

Pipe Cutter

### Prior to Installation

All products manufactured and supplied by Bristan are safe provided they are installed, used correctly and receive regular maintenance in accordance with these instructions.

This product has been tested to the Water Regulations Advisory Scheme (WRAS) and satisfies the requirements of the Water Supply (Water Fittings) Regulations 1999 and current bylaws. For full installation requirements & notes (IRN) please visit [www.wras.co.uk/directory](http://www.wras.co.uk/directory).

We recommend isolation valves to be fitted to the inlet water supplies to ensure ease of future maintenance. Before installing these taps the water supply must be thoroughly flushed in order to remove any swarf, solder etc. This product must not be modified in any way as this will invalidate the guarantee.

Full access must be made available for future maintenance/servicing purposes.

If in doubt, contact a registered plumber or your Local Water Authority or the Secretary of the Institute of Plumbing, address as follows:-

The Institute of Plumbing,  
64 Station Lane,  
Hornchurch,  
Essex,  
RM12 6NB, Tel: 01708 472791

### Pack Contents

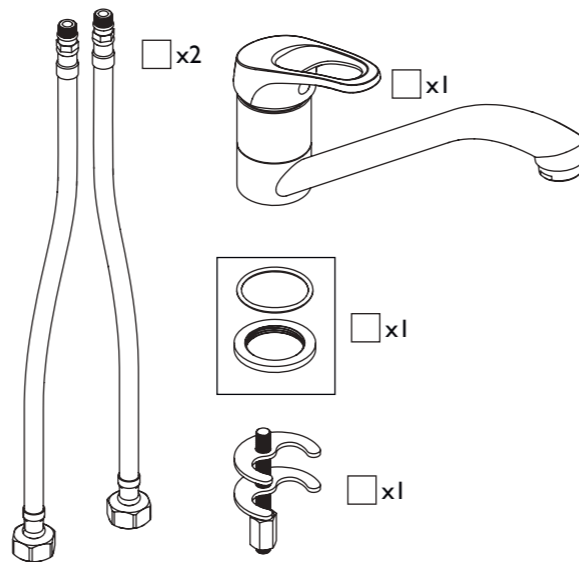

### Spare Parts

To replace any spare parts for your tap, why not scan the QR Code or visit [www.bristan.com](http://www.bristan.com) and search for your product.



### Installation

1

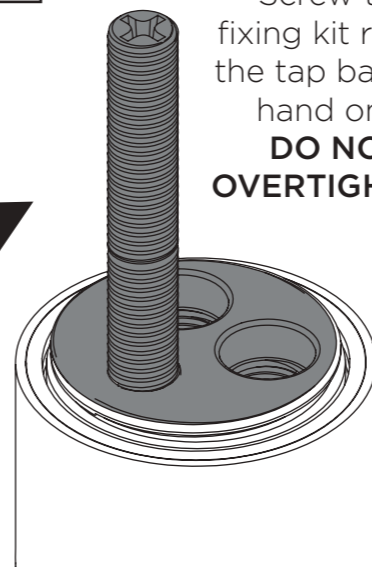
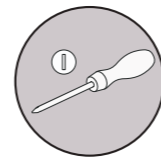

Screw the fixing kit rod to the tap base by hand only. **DO NOT OVERTIGHTEN.**

2

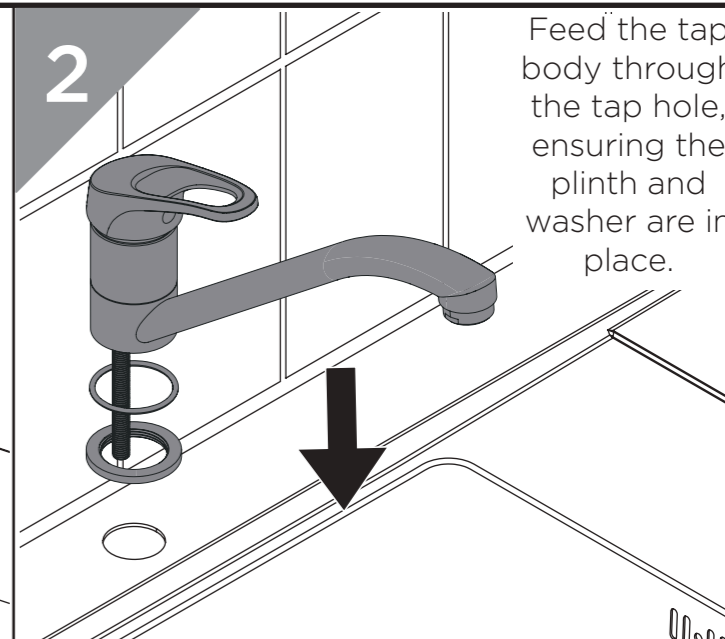

Feed the tap body through the tap hole, ensuring the plinth and washer are in place.

3

Secure the tap body using the fixing kit.

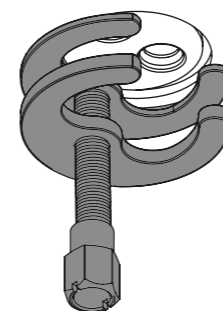
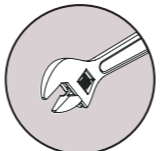

4

**REMEMBER**  
Hot on the left, cold on the right!



Screw the flexible tails to the tap base by hand only. **DO NOT OVERTIGHTEN.**

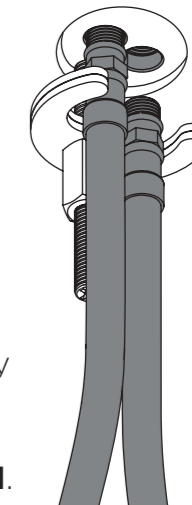
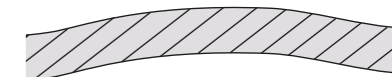

5

**REMEMBER**  
Hot on the left, cold on the right!



Connect the flexible tails to the hot and cold water supplies.

We would recommend that you install flat-faced isolation valves to the water supplies for safety and maintenance purposes

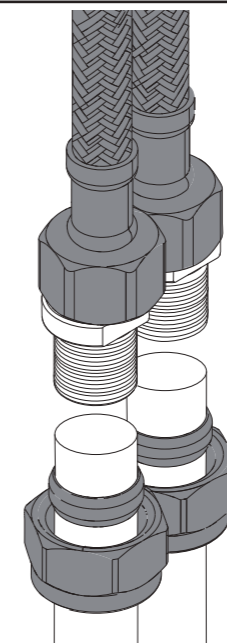
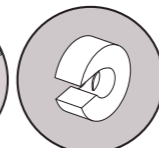
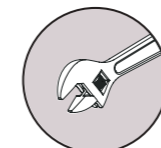

6

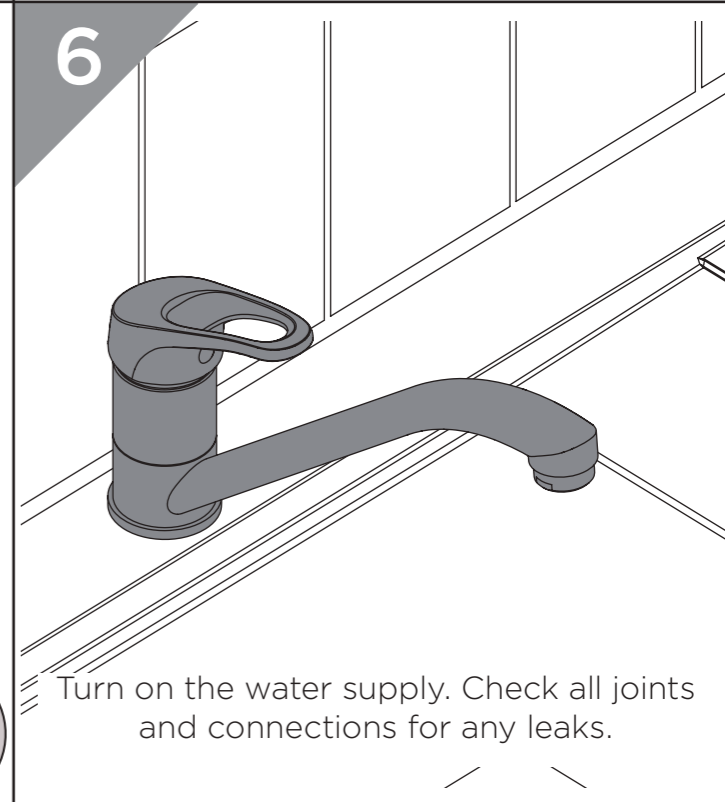

Turn on the water supply. Check all joints and connections for any leaks.

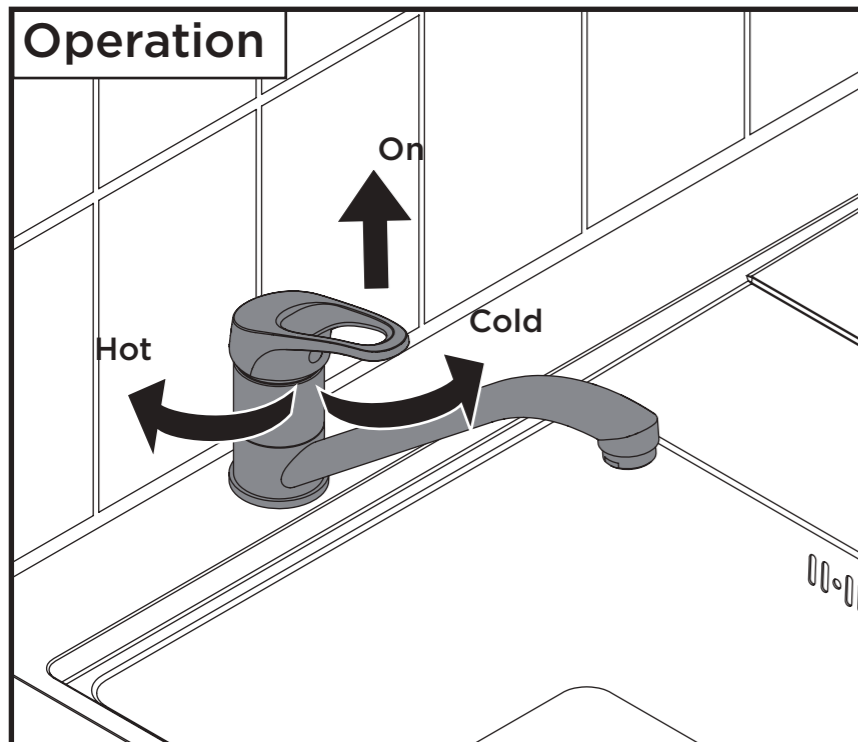

### General Cleaning

Bristan products are made from premium materials, with hand polishing and electroplated finishes.

Your taps or shower should be regularly cleaned with warm water, a mild pH-neutral liquid soap, and polished with a soft cloth. Any residues from soap, toothpaste, shampoos and shower gels can cause blemishes if not rinsed off straight after use.

Household bleaches and cleaners contain harsh chemicals and may damage the surface finish. Avoid using abrasive cloths, scouring pads, scrub sponges, steel wool or anything similar.

Some surfaces such as nickel and pewter may be affected by the dye found in some cloths, so it is also important to avoid hanging cloths on spouts.

### Maintenance - Clean/Replace Outlet

**1**

Remove the outlet using a suitable spanner.

**2**

Check seals for damage. Soak using a suitable solution to de-scale.

**3**

Reverse the steps to replace the outlet.

### Maintenance - Valve Cleaning

**1**

Isolate the water supply before starting!

Prise off the cap and undo the grub screw to remove the handle then unscrew the shroud.

2.5 mm

**2**

Unscrew the valve using an adjustable spanner. Check any seals and O-rings for damage. Replace valve if necessary.

**3**

Place valve in a suitable solution and soak until fully de-scaled.

**4**

Reverse the steps to replace the valve and handle.

### Troubleshooting

Symptom	Cause	Remedy
No flow or low flow rate	Partially closed isolation valve.	Open isolation valve.
	Instantaneous water heater cycles on and off as flow rate or pressure is too low.	Increase water flow rate or pressure through system.
	Head of water is below the minimum distance required.	Refer to specification for minimum distance required.
	Hot or cold water being drawn off elsewhere causing pressure changes or instantaneous boiler temperature changes.	Do not use other water outlets when using the taps.
	Airlock or partial blockage in the supply pipework.	Flush through pipework to ensure removal of debris and any airlocks.
Water dripping from taps	This is normal for a short time after using the taps.	This is caused by residual water tension, the build up of water in the tap body.
	If water continues to drip, possibly due to the ceramic disc valves	Remove valves and clean, refer to 'Maintenance' section before starting any maintenance.
Taps do not turn on	Closed isolation valve.	Open isolation valve.
	Mains water supply turned off.	Turn on mains water supply.

### Notes

Please use this space for any notes you or your installer may have regarding the installation/plumbing of this product.

At Bristan, we want to make things as easy as possible for our customers. That's why we offer solid guarantees on all our products, effective from the date of purchase, to give you peace of mind.

To start your free guarantee simply scan the QR code and register your product. Alternatively visit [www.bristan.com/register](http://www.bristan.com/register) to register your product via a computer. For full guarantee terms and conditions visit [www.bristan.com/guarantees](http://www.bristan.com/guarantees).

