

# Pivot Door & Side Panel

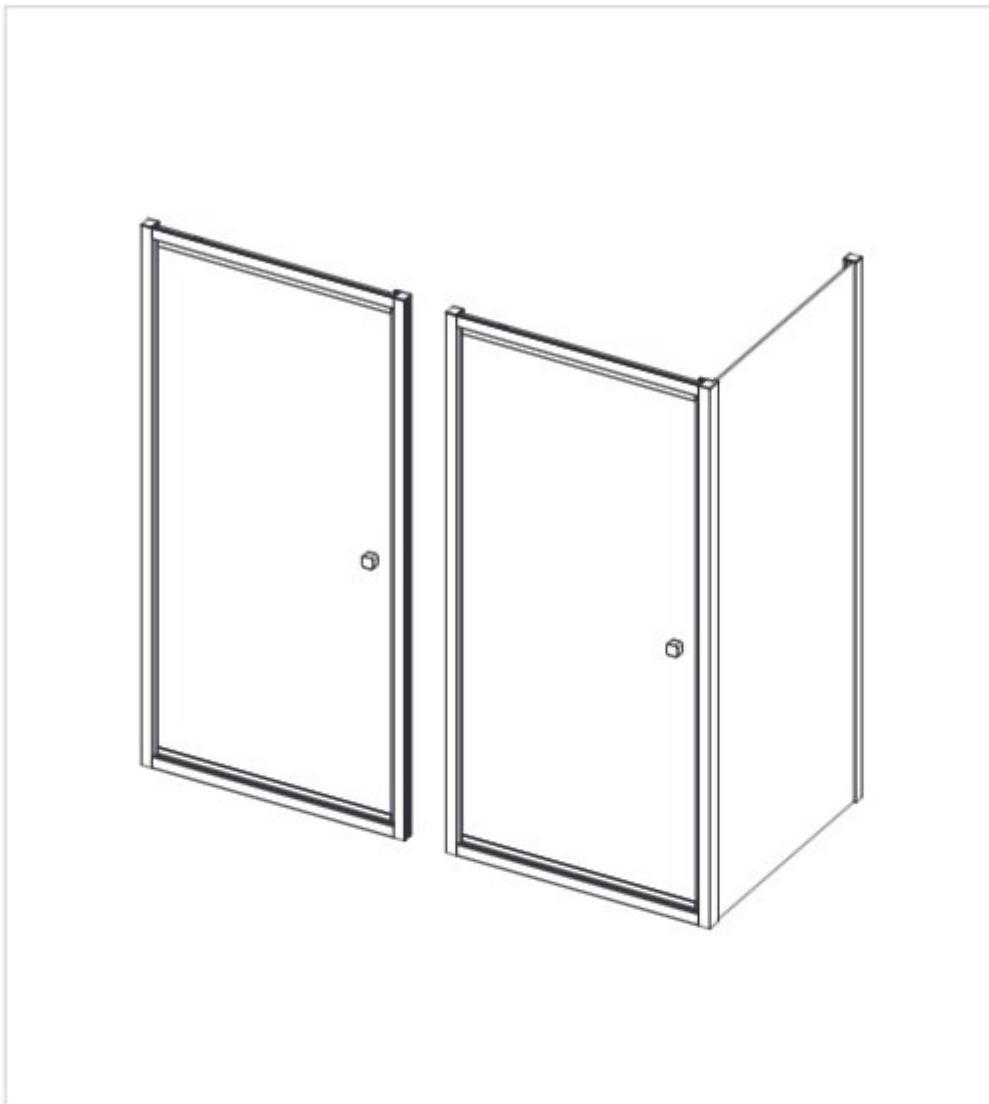

## PRODUCT CODES:

CAPDSC0800_V2	CASPSC0700_V2
CAPDSC0900_V2	CASPSC0760_V2
CAPDBC0800_V2	CASPSC0800_V2
CAPDBC0900_V2	CASPSC0900_V2
CAPDFC0800_V2	CASPBC0700_V2
CAPDFC0900_V2	CASPBC0760_V2
CAPDVC0800	CASPBC0800_V2
CAPDVC0900	CASPBC0900_V2
CAPDBZC0800	CASFBC0700
CAPDBZC0900	CASFBC0760_V2
CAPDTC0800	CASFBC0800_V2
CAPDTC0900	CASFBC0900_V2
HXPDSC0800	CASPVC0700
HXPDSC0900	CASPVC0760
HXPDBC0800	CASPVC0800
HXPDBC0900	CASPVC0900
HXPDFC0800	CASPBZC0700
HXPDFC0900	CASPBZC0760
	CASPBZC0800
	CASPBZC0900
	CASPTC0700
	CASPTC0760
	CASPTC0800
	CASPTC0900
	HXSPSC0700
	HXSPSC0760
	HXSPSC0800
	HXSPSC0900
	HXSPBC0700
	HXSPBC0760
	HXSPBC0800
	HXSPBC0900
	HXSFBC0700
	HXSFBC0760
	HXSFBC0800
	HXSFBC0900

## 1. Pre-Installation Checklist

### ☑ Before You Begin:

- Ensure all tiling/grouting is complete.
- Shower tray **must be level and sealed** to tiles.
- Verify door dimensions match your space (see Section 3).
- Check for hidden pipes/cables before drilling.

### ⚠ Safety Notes:

- **Two people required** for installation (glass is heavy!).
- Wear gloves when handling glass edges.

## 2. Unpacking & Components

### Confirm all parts are present:

- Please refer to all components included on following page titled “COMPONENTS”

### Missing/Damaged Parts?

Contact Bathroom Brands immediately: ☎0345 873 8840.

## 3. Step-by-Step Installation

### A. Frame Assembly

#### 1) Mark Drill Points:

- Use a spirit level to mark vertical lines for wall profiles.
- Drill 6mm holes at marked points; insert wall plugs.

#### 2) Attach Wall Profiles:

- Secure profiles with ST4x50mm screws (x8 total).
- Cover ends with profile caps if any.

### B. Door Installation

#### 3) Hang the Door:

- Following the instruction to assemble the door, ensure door is fully secured.
- Make necessary adjustment if door doesn't close smoothly.

#### 4) Apply Seals:

- Install necessary seals provided on door and side panel if any.

### C. Final Checks

#### 5) Level & Secure:

- Confirm door is level; tighten all screws.
- Let silicone cure for 24 hours before use.

## 4. Care & Maintenance







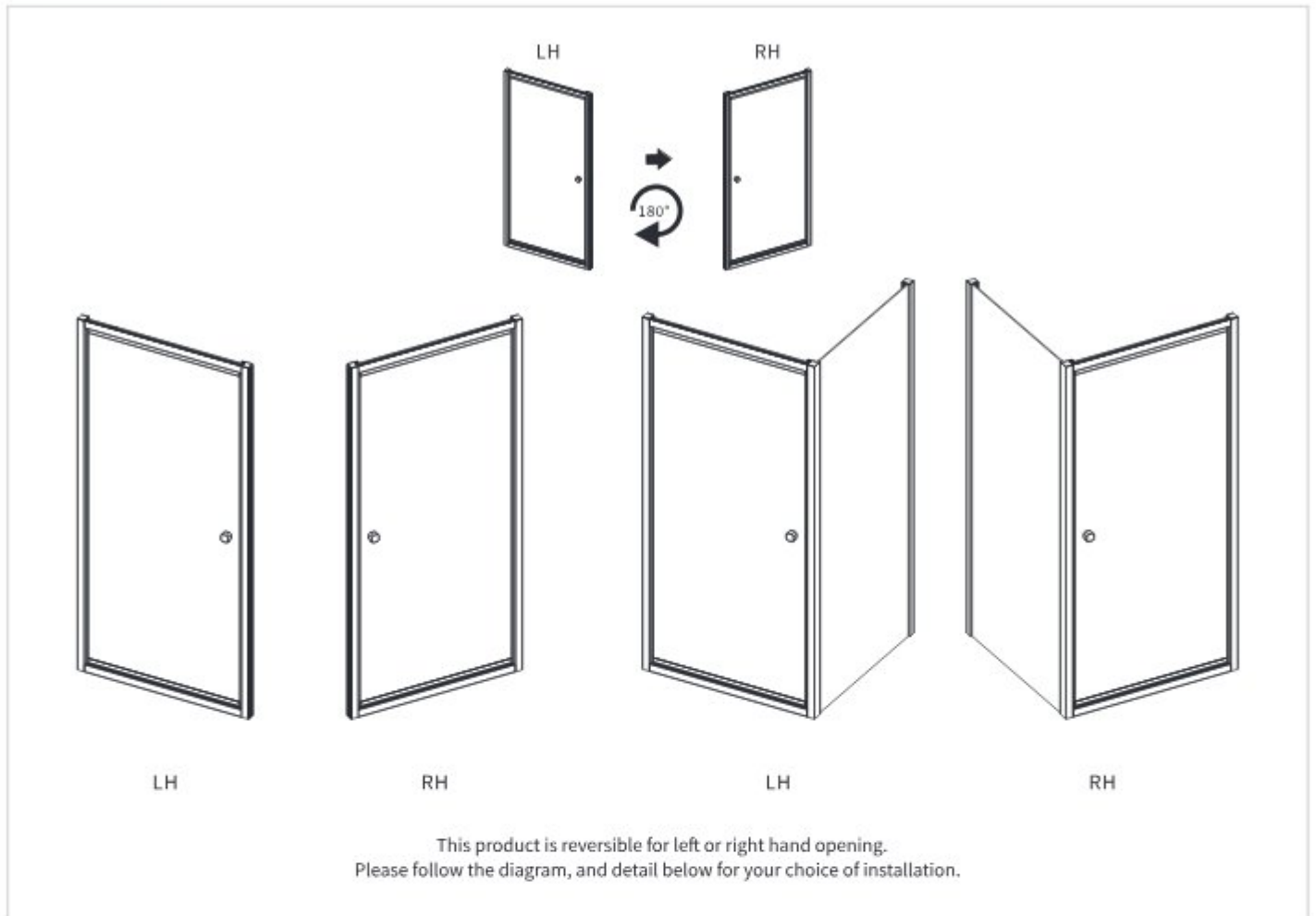

- **Cleaning:** Use only **pH-neutral soapy water** (pH 6.8–7.2).
- **Avoid:** Abrasives, solvents, or acidic cleaners.

Ensure seals are flush to prevent leaks.

## ORIENTATION









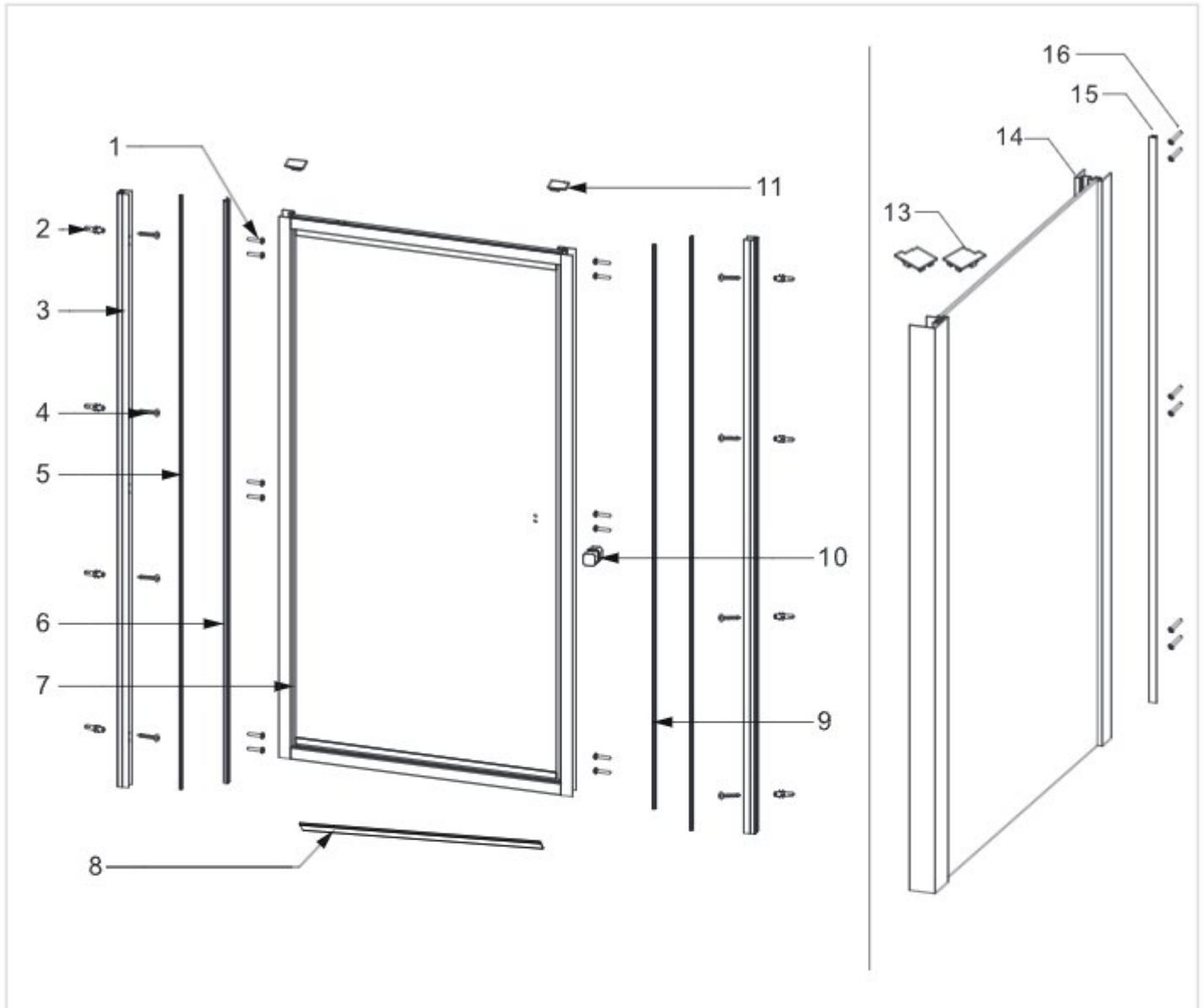

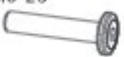







### Tools Required (not supplied):

Spirit Level		Torque Screw Driver	
Pencil		Snips	
Drill		6mm Drill Bit	
Silicone		Measuring Tape	
Knife			

# COMPONENTS



<b>1</b> Screw M5*25  x12	<b>2</b> Wall Plug  x8	<b>3</b> Wall Profile  x2	<b>13</b> Corner profile cap  RH LH x1
<b>4</b> Screw ST4*50  x8	<b>5</b> Wall Profile Cover Strip L=1950mm  x2	<b>6</b> Moving panel seal  x1	<b>14</b> Side Panel  x1
<b>7</b> Moving door  x1	<b>8</b> Bottom seal  x1	<b>9</b> Moving panel magnetic seal  x1	<b>15</b> Wall Profile Cover Strip L=1950mm  x1
<b>10</b> Handle  x1	<b>11</b> Wall Profile Cap  x2	<b>12</b> Allen Key  3mm	<b>16</b> Screw M5*25  x6

# INSTALLATION

1

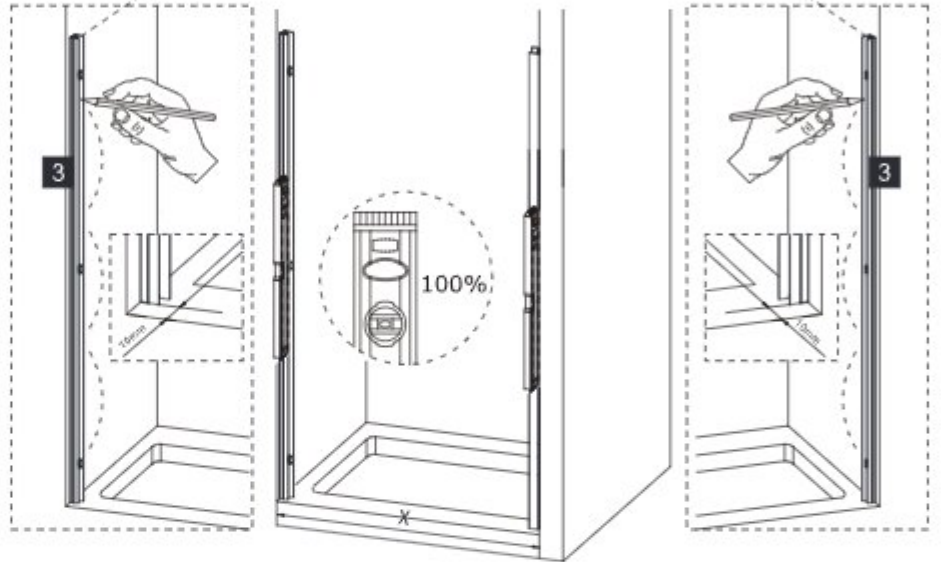
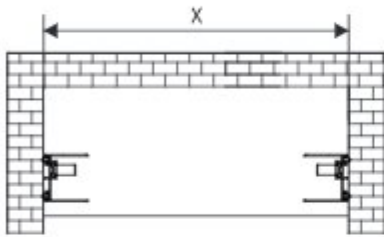
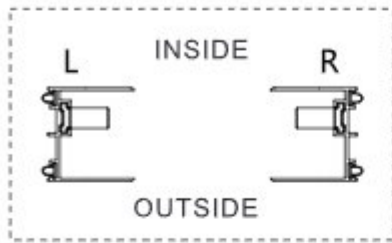

Product	X(mm)
Pivot Door 800	750-780
Pivot Door 900	850-880

2

LH

RH

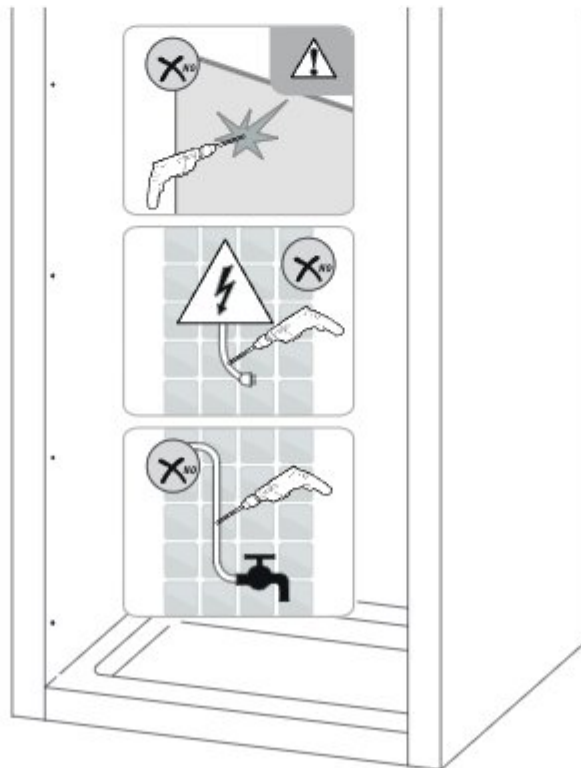
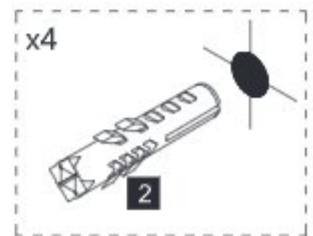
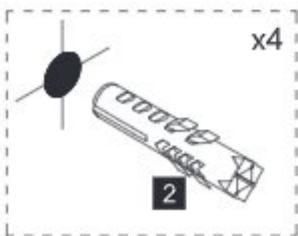
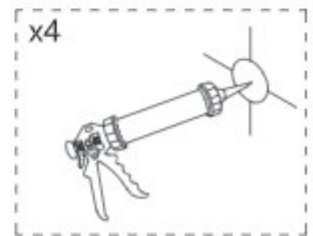
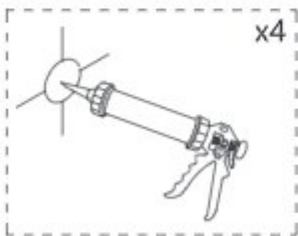
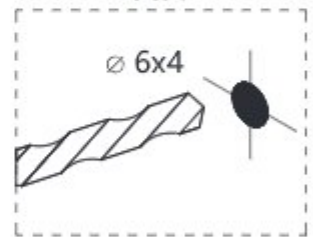
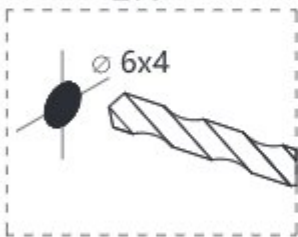



# INSTALLATION

5

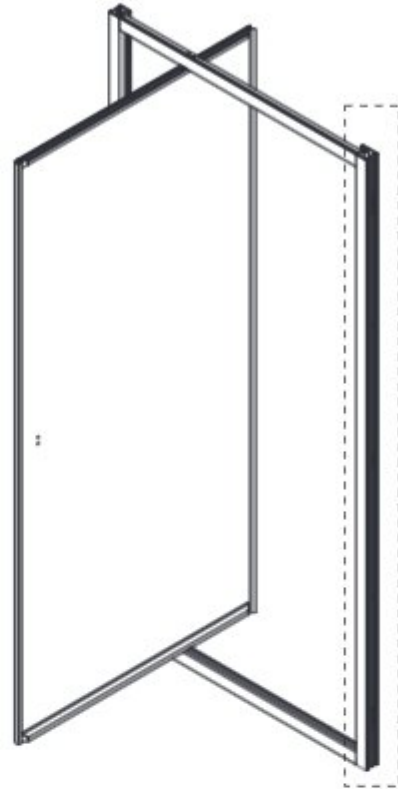
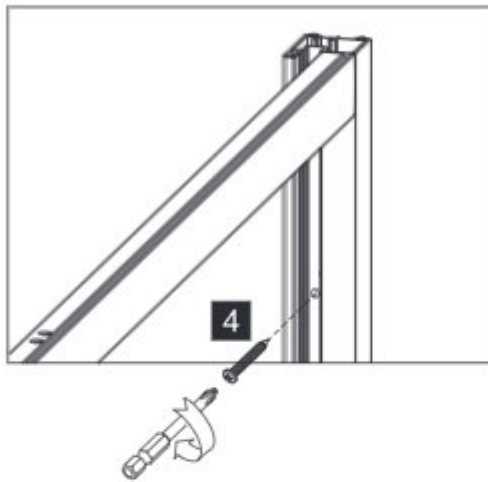

6

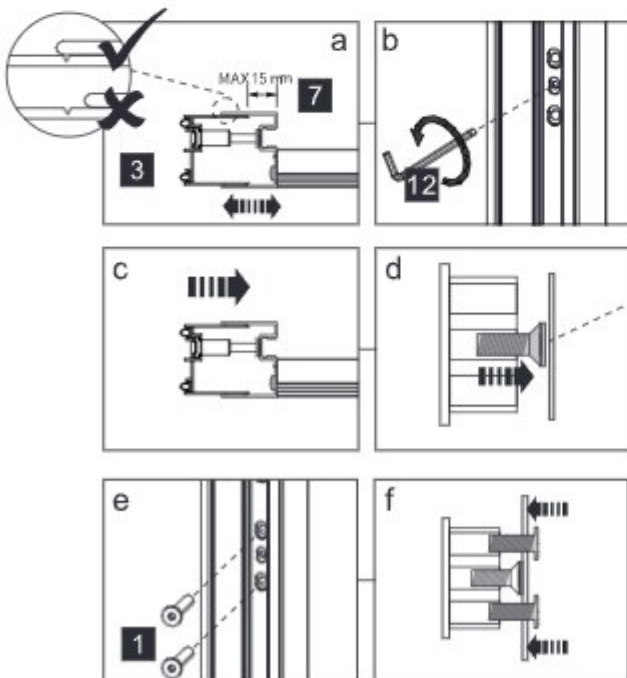

Ensure the door is level. Adjust if needed, then lock the screw till it touches and supports the door frame.

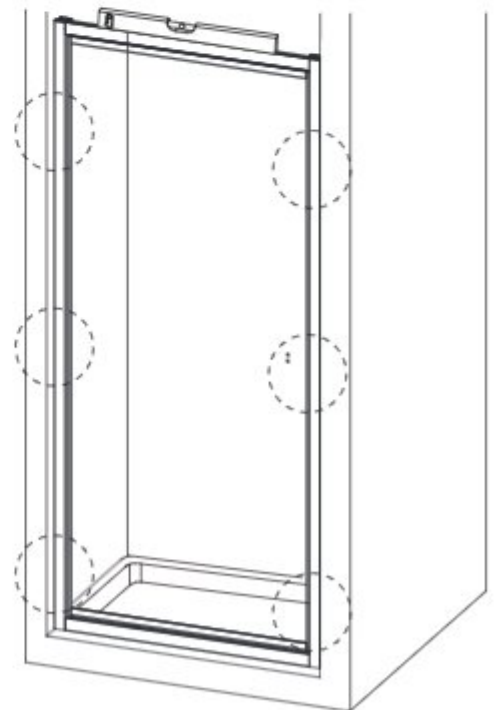

# INSTALLATION

7

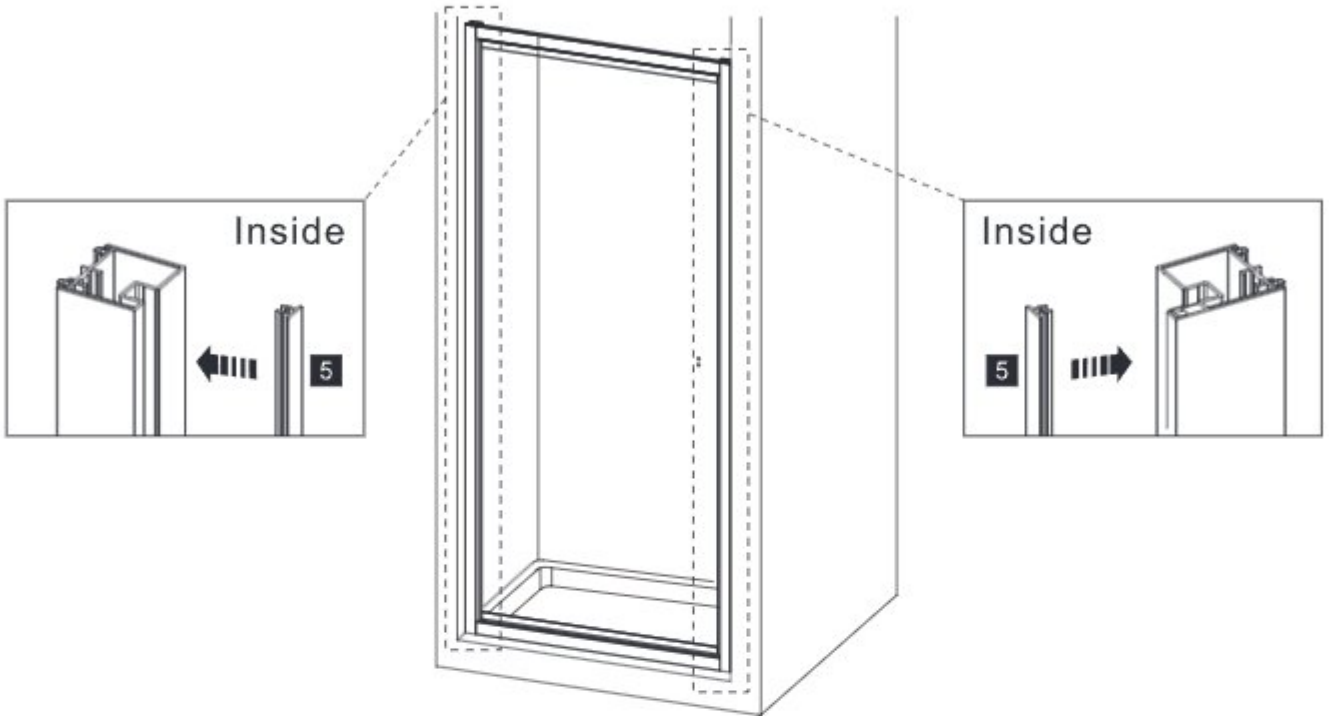

8

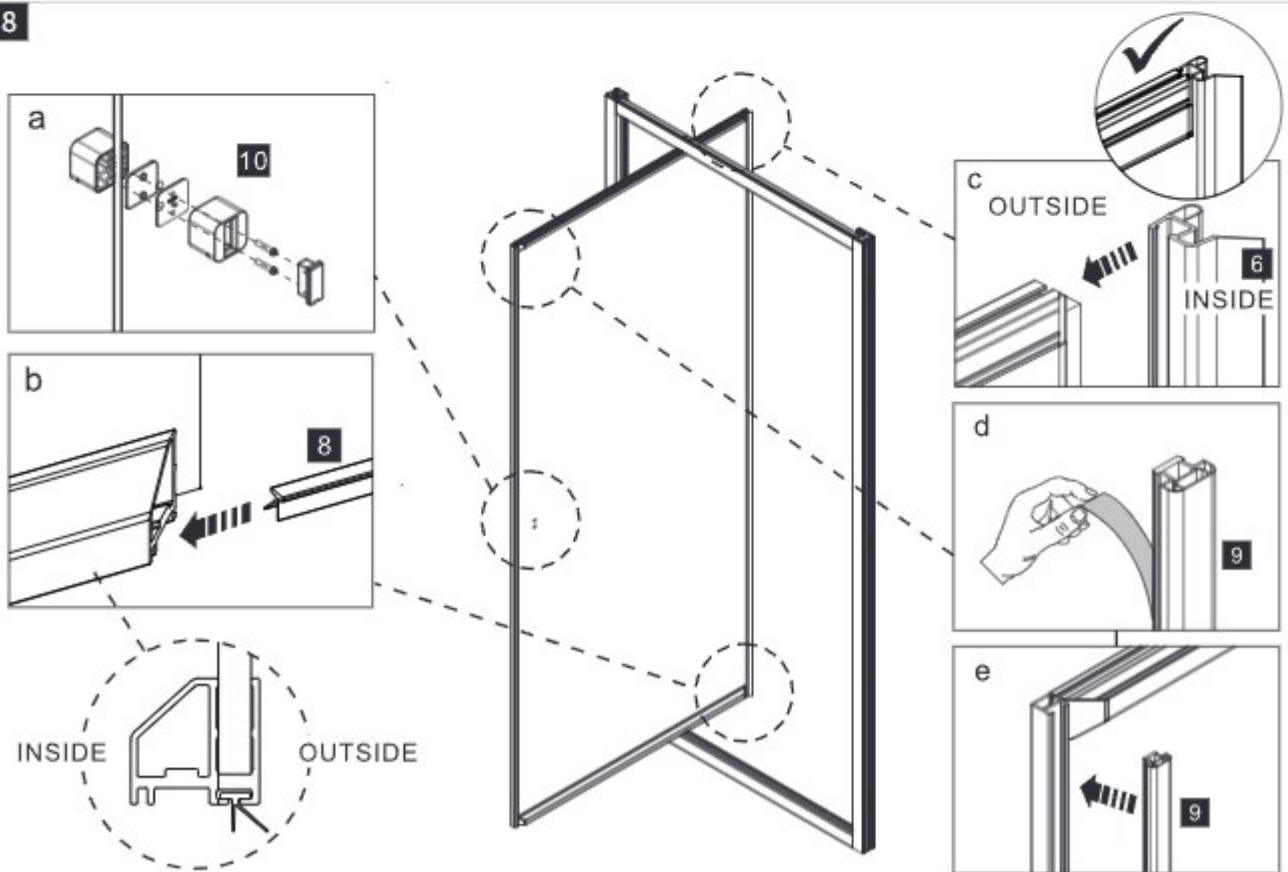

# INSTALLATION

9

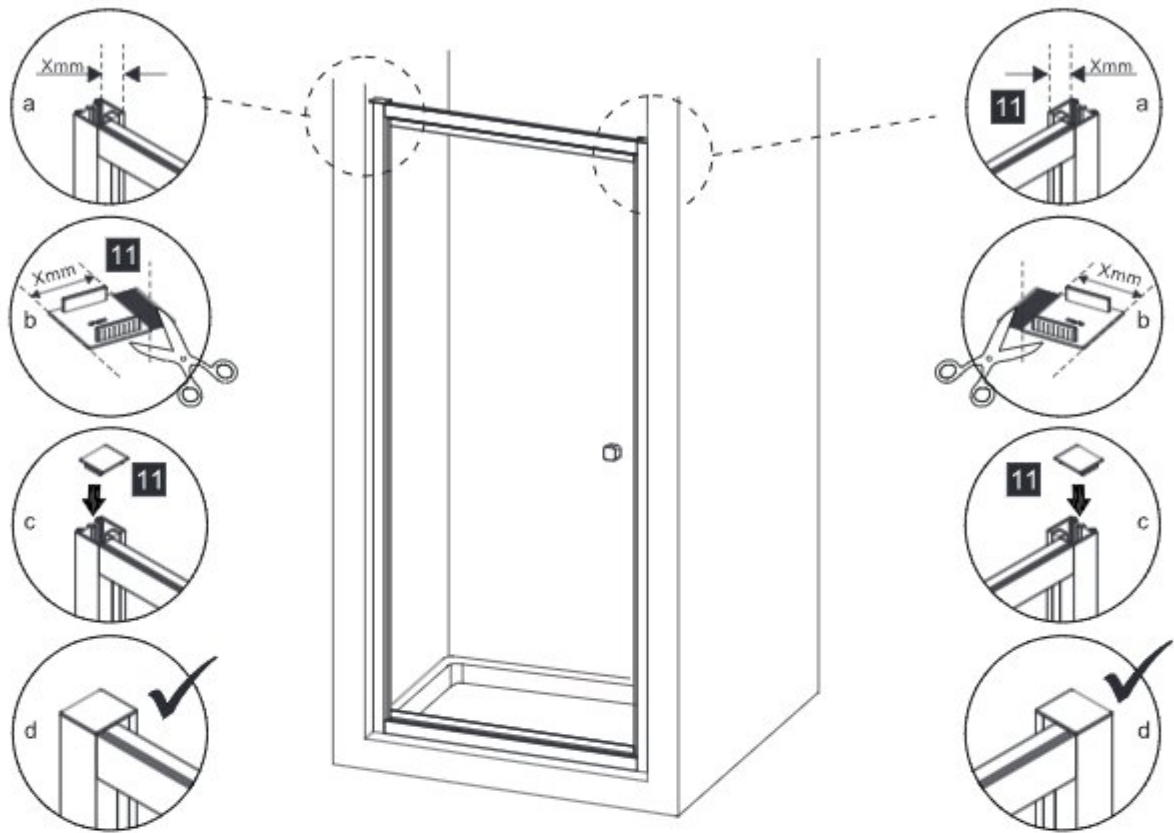

10

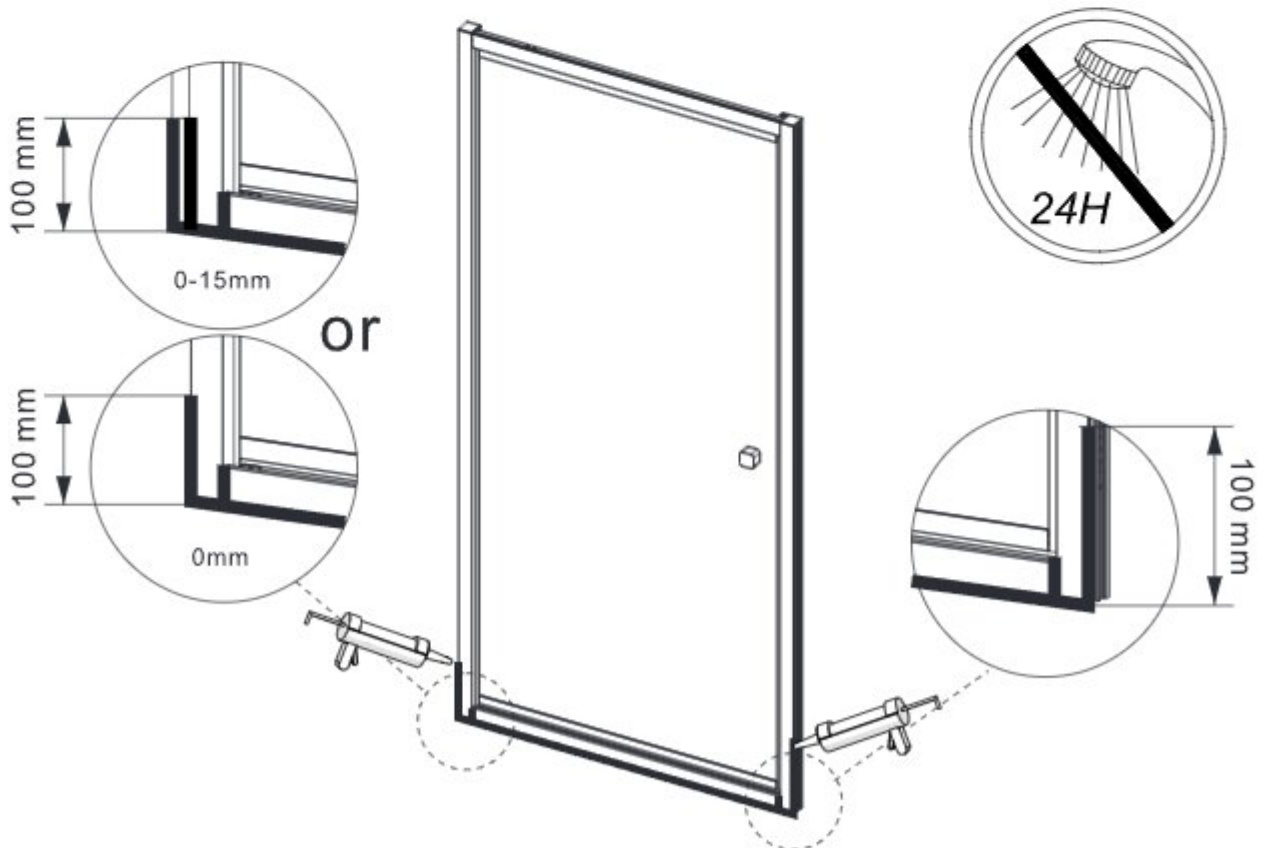

## INSTALLATION

11

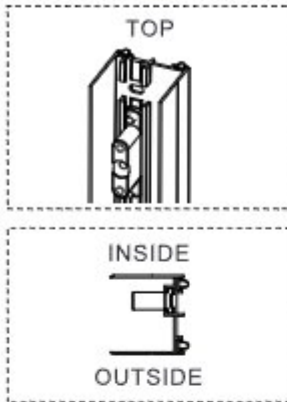

Product	X(mm)
Pivot Door 800	750-780
Pivot Door 900	850-880

Product	Y(mm)
Side Panel 700	853-868
Side Panel 760	713-728
Side Panel 800	753-768
Side Panel 900	853-868

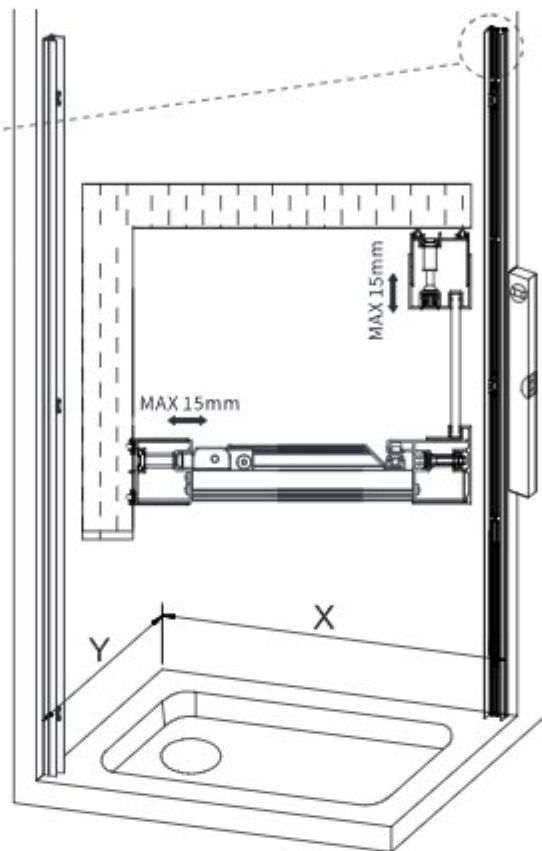

12

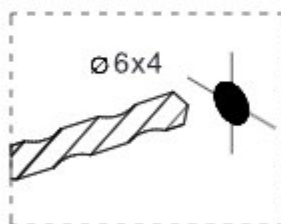

x4

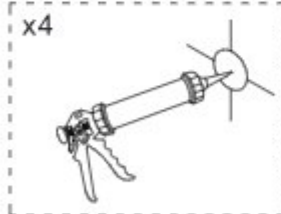

x4

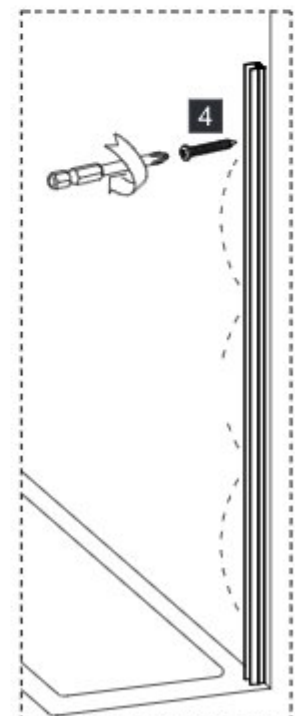
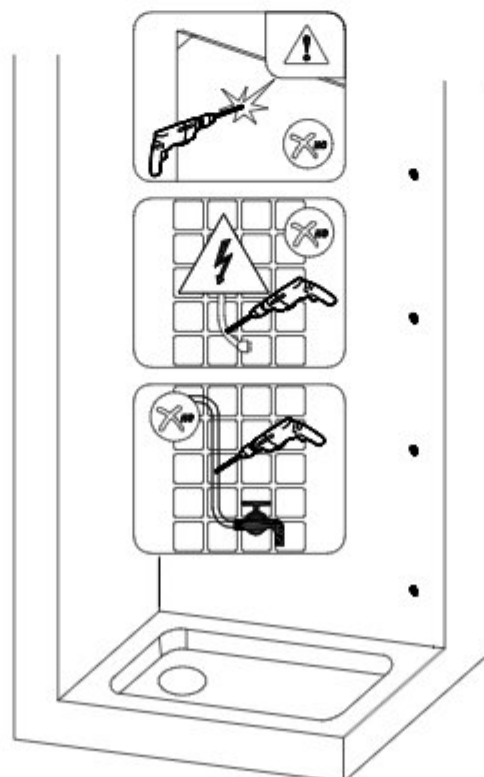
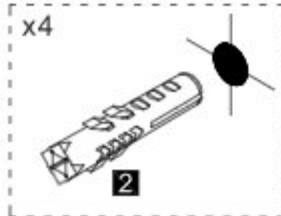

# INSTALLATION

13

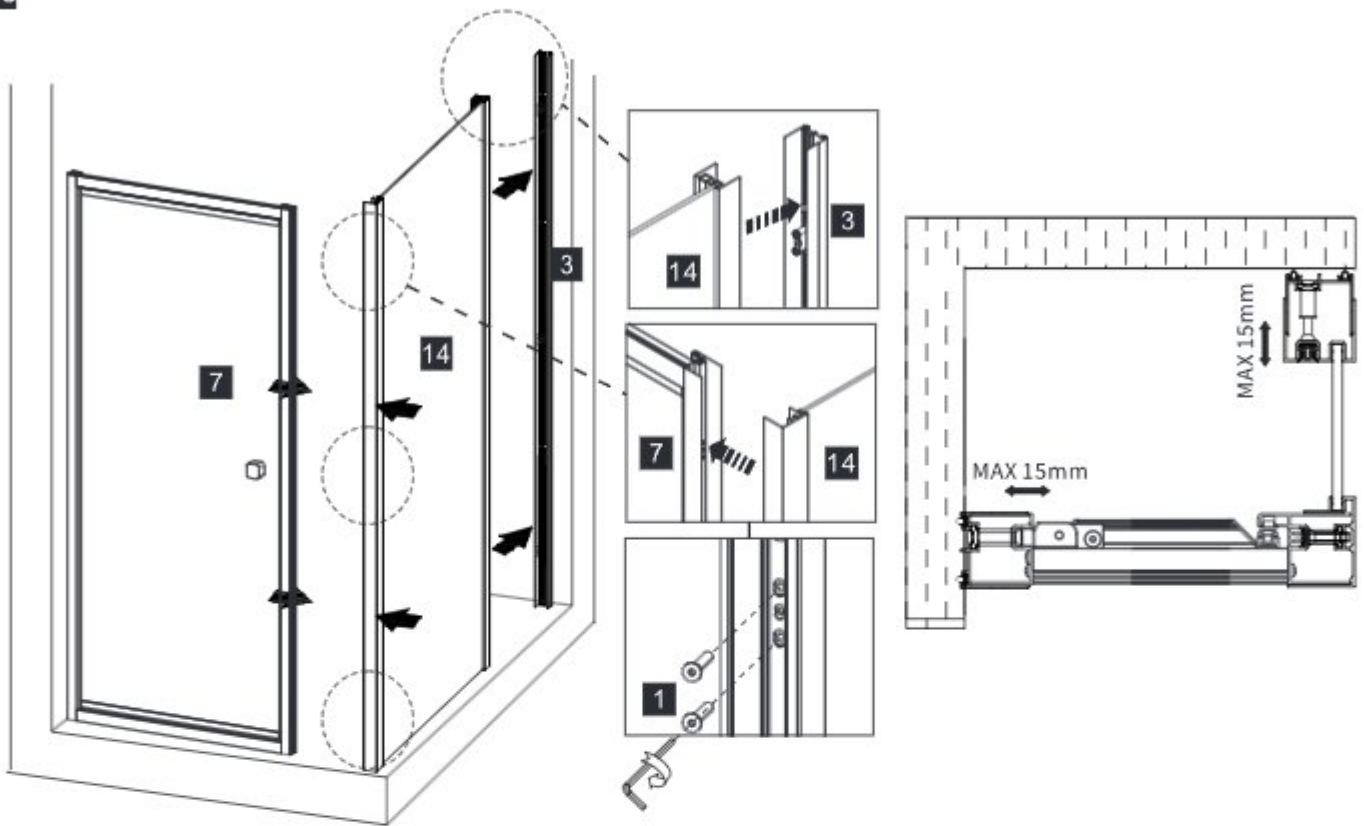

14

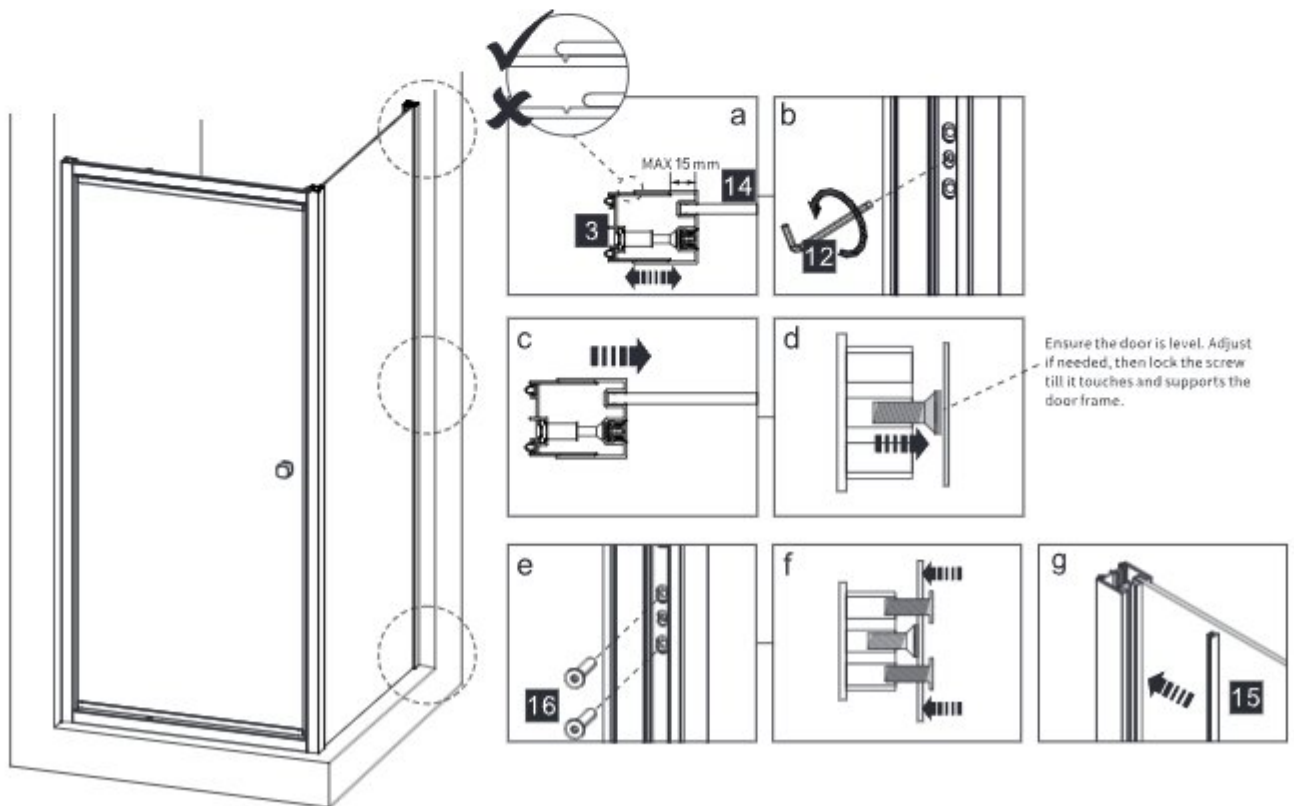

## INSTALLATION

15

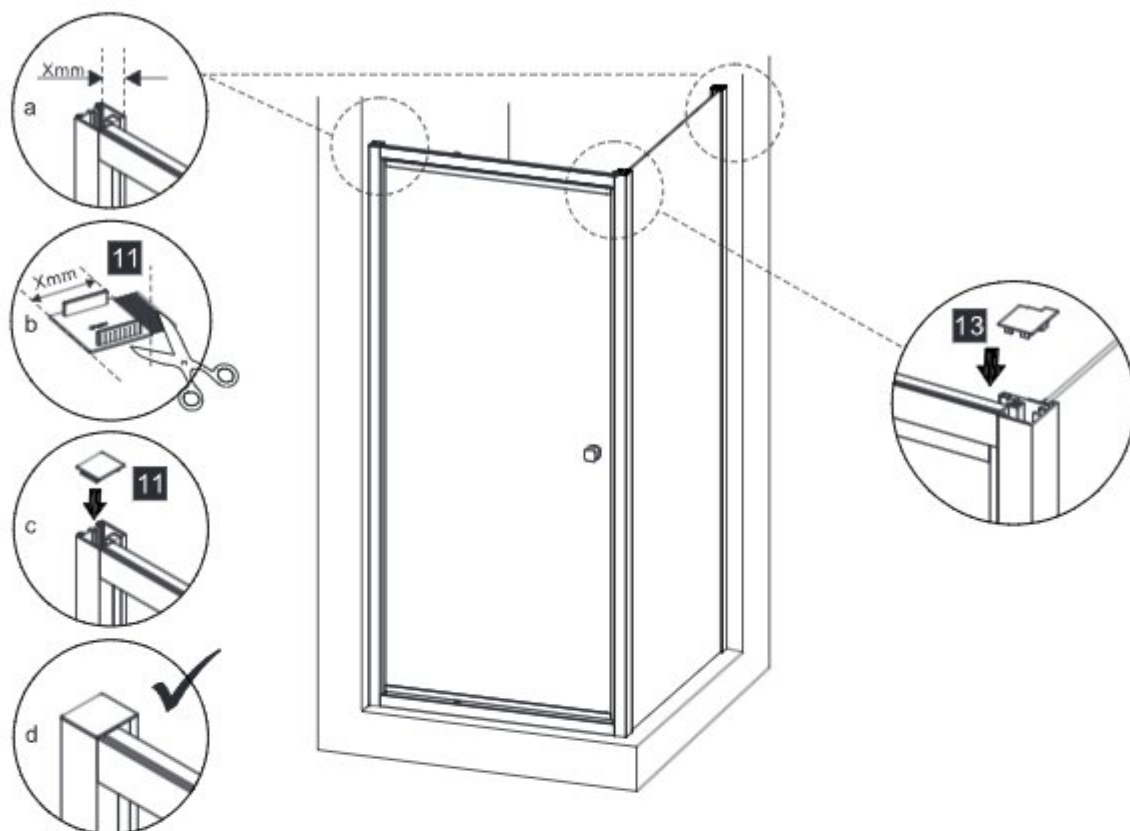

16

